

2008

# Simulating energy efficiency in laboratory buildings

Robert Marcel Milbrandt  
*Iowa State University*

Follow this and additional works at: <https://lib.dr.iastate.edu/rtd>



Part of the [Mechanical Engineering Commons](#)

---

## Recommended Citation

Milbrandt, Robert Marcel, "Simulating energy efficiency in laboratory buildings" (2008). *Retrospective Theses and Dissertations*. 14910.  
<https://lib.dr.iastate.edu/rtd/14910>

This Thesis is brought to you for free and open access by the Iowa State University Capstones, Theses and Dissertations at Iowa State University Digital Repository. It has been accepted for inclusion in Retrospective Theses and Dissertations by an authorized administrator of Iowa State University Digital Repository. For more information, please contact [digirep@iastate.edu](mailto:digirep@iastate.edu).

Simulating energy efficiency in laboratory buildings

by

Robert Marcel Milbrandt

A thesis submitted to the graduate faculty  
in partial fulfillment of the requirements for the degree of  
MASTER OF SCIENCE

Major: Mechanical Engineering

Program of Study Committee:  
Gregory M. Maxwell, Major Professor  
Ron M. Nelson  
Steven J. Hoff

Iowa State University

Ames, Iowa

2008

Copyright © Robert Marcel Milbrandt, 2008. All rights reserved.

UMI Number: 1450156



---

UMI Microform 1450156

Copyright 2008 by ProQuest Information and Learning Company.  
All rights reserved. This microform edition is protected against  
unauthorized copying under Title 17, United States Code.

---

ProQuest Information and Learning Company  
300 North Zeeb Road  
P.O. Box 1346  
Ann Arbor, MI 48106-1346

## Table of Contents

List of Figures .....	iii
List of Tables .....	iii
Acknowledgements.....	v
Chapter 1: Introduction.....	1
Chapter 2: Review of Literature .....	4
Chapter 3: The Model .....	7
Occupancy – Lighting - Equipment.....	9
Schedules .....	10
Ventilation.....	11
Energy Recovery.....	12
Creating Systems .....	12
Assigning Rooms to Systems.....	13
Creating Plants .....	15
Economics.....	16
Simulating the Base Case.....	16
Chapter 4: Energy Conservation Opportunities.....	26
Case 1: Reducing Ventilation Airflow and Fume Hood Exhaust.....	26
Case 2: Enthalpy Wheel.....	30
Case 3: Adding Enthalpy Wheels to AHU’s 3 and 4.....	33
Case 4: Recover Energy from Fume Hood Exhaust .....	35
Case 5: Utilize Year-Round Energy Recovery .....	38
Chapter 5: Conclusions .....	42
References.....	44

## List of Figures

Figure 1.1	Roy J. Carver Co-Lab.....	1
Figure 1.2	Cooling Requirements for a Lab and Office Air Handler .....	2
Figure 1.3	Heating Requirements for a Lab and Office Air Handler .....	2
Figure 3.1	3-D view of the Building Model .....	9
Figure 3.2	Mechanical Equipment Assigned to each Particular Zone.....	14
Figure 3.3	Mechanical Equipment Assigned to each Particular Zone.....	14
Figure 3.4	Mechanical Equipment Assigned to each Particular Zone.....	15
Figure 3.5	Predicted versus actual Chilled Water Usage.....	19
Figure 3.6	Predicted versus actual Natural Gas Usage.....	19
Figure 3.7	Avg. Measured Temperature vs. Average TMY2 Temperature.....	21
Figure 3.8	Avg. Measured Solar Irradiation vs. Average TMY2 Solar Irradiation.....	22
Figure 3.9	Avg. Measured Relative Humidity vs. Average TMY2 Relative Humidity .....	22
Figure 3.10	Average Monthly Heating Demand Predicted by TRACE .....	24
Figure 3.11	Average Monthly Cooling Demand Predicted by TRACE .....	24
Figure 3.12	Annual Building Energy Use Predicted by TRACE .....	25
Figure 4.1	Average Monthly Heating Demand for Case 1 and the Base Case.....	27
Figure 4.2	Average Monthly Cooling Demand for Case 1 and the Base Case.....	28
Figure 4.3	Diagram of Run-Around Loop .....	30
Figure 4.4	Diagram of Enthalpy Wheel.....	31
Figure 4.5	Average Monthly Heating Demand for Case 2 and the Base Case.....	31
Figure 4.6	Average Monthly Cooling Demand for Case 2 and the Base Case.....	31
Figure 4.7	Average Monthly Heating Demand for Case 3 and the Base Case.....	33
Figure 4.8	Average Monthly Cooling Demand for Case 3 and the Base Case.....	34
Figure 4.9	Average Monthly Heating Demand for Case 4 and the Base Case.....	36
Figure 4.10	Average Monthly Cooling Demand for Case 4 and the Base Case.....	36
Figure 4.11	Average Monthly Heating Demand for Case 5 and the Base Case.....	38
Figure 4.12	Average Monthly Cooling Demand for Case 5 and the Base Case.....	39
Figure 4.13	Summary of Proposed Energy Savings .....	41
Figure 4.14	Summary of Proposed Cost Savings .....	41

## List of Tables

Table 3.1	Above and Below Grade Wall Details.....	7
Table 3.2	Roof and Ceiling Details.....	8
Table 3.3	Window and Door Details .....	8
Table 3.4	Occupancy, Lighting & Equipment Power Densities for each Type of Zone ..	10
Table 3.5	Load factors for Various Schedules.....	11
Table 3.6	Details of the Mechanical Equipment.....	13
Table 3.7	Marginal Rates for Natural Gas, Electricity, and Chilled Water .....	16
Table 3.8	Comparison of TRACE Design Parameters to Installed System Capacities .....	17
Table 3.9	Annual Building Energy Use Predicted by TRACE.....	25

Table 4.1 Schedule Changes for the Case 1 Simulation .....	27
Table 4.2 Annual Energy Savings with Case 1.....	28
Table 4.3 Annual Cost Savings with Case 1.....	29
Table 4.4 Annual Energy Savings with Case 1.....	32
Table 4.5 Annual Cost Savings with Case 1.....	32
Table 4.5 Annual Cost Savings with Case 2.....	34
Table 4.7 Annual Cost Savings with Case 3.....	35
Table 4.8 Annual Energy Savings with Case 4.....	37
Table 4.9 Annual Cost Savings with Case 4.....	37
Table 4.10 Annual Energy Savings with Case 5.....	39
Table 4.11 Annual Cost Savings with Case 5.....	40
Table 4.12 Summary of Energy and Cost Savings for Each Case.....	40

## **Acknowledgements**

This project would not have been possible without the help and guidance of a few knowledgeable people. I would like to thank my advisor Dr. Greg Maxwell for his guidance through the entire thesis process. It was a pleasure working under his direction. Mr. Peter Lelonek was instrumental in giving me access to all the information pertaining to Carver Co-Lab. I would like to thank Pete for all he has helped me with in this project. This project was also an opportunity for me to learn about TRACE software. I would like to thank Mr. Brad Perkins for helping with problems that I encountered with the software. A portion of the data in this report was taken from the Energy Resource Station in Ankeny, IA. I would like to thank Mr. Xiaohui Zhou for his help in gathering this data.

Finally, I would like to thank the faculty members who participated in my committee: Dr. Ron Nelson, and Dr. Steve Hoff. Their time and effort was greatly appreciated.

## Chapter 1: Introduction

This project is an energy study for the Roy J. Carver Co-Lab. Built in 2002, the Carver Co-Lab (Figure 1.1) is a home for administrative and faculty offices and laboratories for the Plant Sciences Institute at Iowa State University in Ames, IA. Its rooms are comprised of a mixture of lab and office spaces.



Figure 1.1 Roy J. Carver Co-Lab

The lab spaces at Carver Co-Lab maintain a very high ventilation rate of 10 air changes per hour (ACH). These spaces are 100% outdoor air spaces, meaning they do not allow for the recirculation of any conditioned air. The energy required to condition the outdoor air outweighs all other sources of heat loss or heat gain in the spaces. Figures 1.2 and 1.3 show a comparison between the cooling and heating load requirements for a



lab AHU and an office AHU in the Carver Co-Lab, respectively for one of the laboratory Air Handlers in the building.

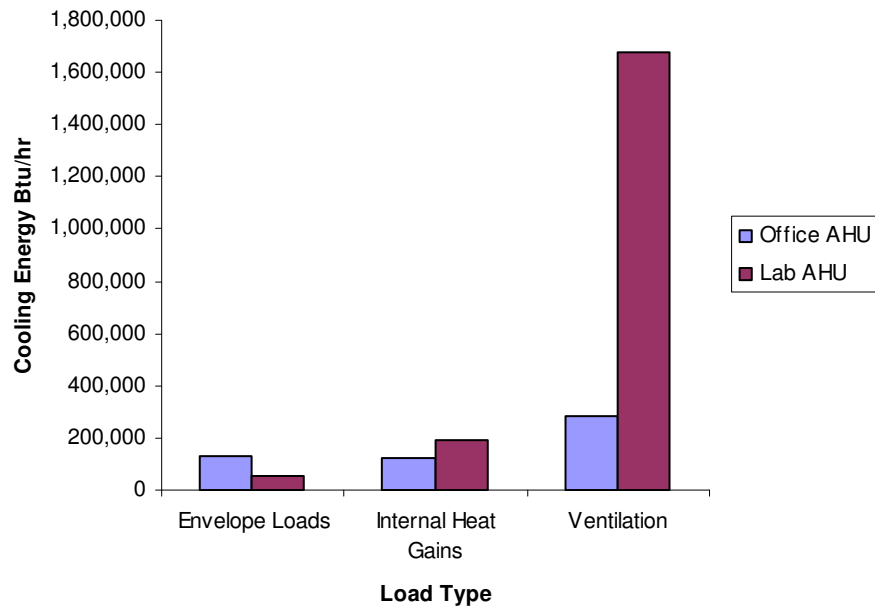

Figure 1.2 Cooling Requirements for a Lab and Office Air Handler

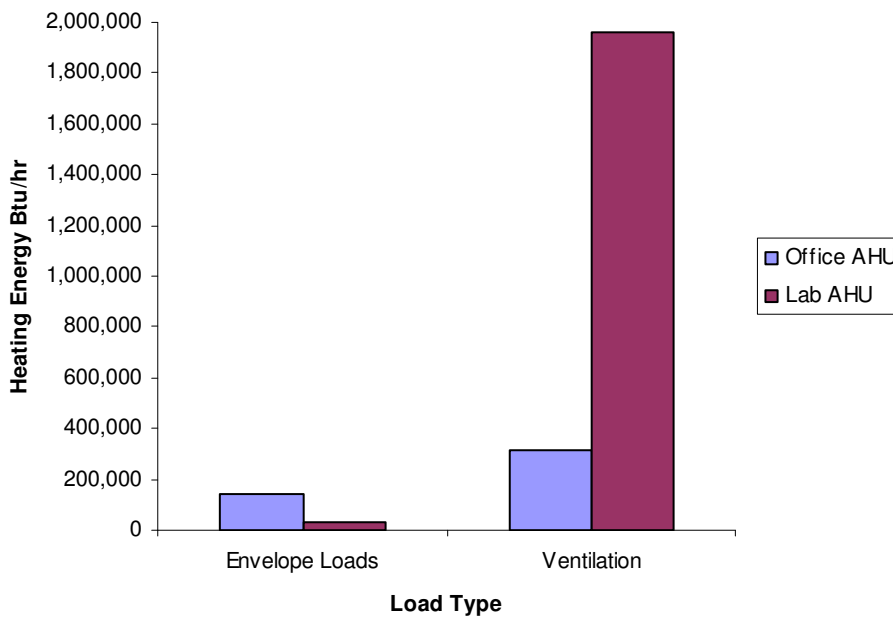

Figure 1.3 Heating Requirements for a Lab and Office Air Handler

As seen from the above graphs, the energy needed to condition ventilation air outweighs energy needed to condition internal loads and envelope loads for both the lab and office air handler. In a 100% outdoor air system, the ventilation load is the only load seen by the coil. Therefore in a lab building, upgrades to the building envelope or a modification to the internal load has no bearing on the coil load granted that the ventilation flow rate exceeds the flow rate required to condition the internal losses or gains. For this reason, the ventilation strategy of a lab building will determine a large portion of the lab's energy use. This study focuses only on the ventilation portion of the buildings' HVAC system because of its dominant impact on the buildings energy use. The most effective way reducing building energy usage in a building of this type is to effectively manage the ventilation. Savings in other areas such as the building's envelope or electric power consumption will be small in comparison to this. It should be noted that the greenhouse portion of the Carver Co-Lab is not included in this study.

## Chapter 2: Review of Literature

This underlying theme of this project is energy efficiency in lab buildings. Even though this study is focused only on the building's ventilation system, other items in the building's design must be considered. In this chapter, a collection of articles pertaining to efficient design and operation of laboratory buildings are summarized.

A large portion of the energy load on a laboratory building is its ventilation loads. These labs typically require 100% outside air. The ventilation rates of these buildings ranges from 6-12 air changes per hour (ACH). The energy needed to move and condition this amount of air is often five times greater than that of an office building's energy for ventilation. (VanGeet et al, 2006). The authors discuss the options for heat recovery in laboratory buildings. They explained the advantages and disadvantages of sensible vs. total energy recovery devices, such as enthalpy wheels, run-around loops, and heat pipes. Items to consider in a heat recovery action include: Contamination, Space Requirements and Duct Adjacencies, Hazardous Chemicals, Humidity, Maintenance, Part-Load Operation, and Redundancy.

Brown (1996) discusses the importance of laboratory design loads. The author notes that laboratory equipment loads can vary from 2 W/ft<sup>2</sup> to 60 W/ft<sup>2</sup> with usage factors ranging from 10% to almost continuously. The author stresses the fact that sizing an equipment load based on the equipment nameplate information will result in a gross over sizing. Laboratory ventilation loads can also range from 6 to 27 ACH, depending on the type of lab. The author recommends that care be taken during the selection process of fume hoods, because of the variations in exhaust flow due to sash design. Finally, he discusses the importance of ventilation controls and the significance of reducing the ventilation rate based on occupancy.

Mathew et al (2005) wrote an article comparing actual power densities in lab buildings with assumptions made to size equipment. The authors note that overestimation of equipment loads will result in oversized HVAC systems. Oversized equipment adds increased initial construction costs and part load operation of equipment. Underestimation of equipment-load variation across zones results in increased reheat energy. The authors stress the importance of right-sizing of equipment.

Brown(2) (1996) discusses the advantages of evaporative pre-cooling and its applications for pre-conditioning outside air. In some cases, when coupled with direct evaporative cooling, it is possible to completely eliminate a refrigerant based cooling system. In systems with 100% OA, evaporative pre-cooling can reduce the conventional based cooling load in half. Ventilation air pre-cooling is less effective in warm and humid climates, but it can be effective, nonetheless. The effectiveness of evaporative pre-cooling is based on design day temperature depressions (i.e. Dry bulb temperature minus wet-bulb temperature) and typical bin data depressions over the operating period. Increased energy costs such as pressure drop through the pre-cooling coil and pump energy can make the evaporative cooling option non-viable. This is the case when the temperature depressions over the cooling season are low.

Rios (1999) wrote an article about laboratory fume hoods and air-flow control systems. The article discusses fume hoods and the control systems that manage their flow. Constant flow fume hoods use bypasses to control the face velocity through the sash. Variable volume systems can limit the flow through the sash to save energy, but also require more controls with add to the complexity and cost. An important issue in the design of the laboratory is the air flow control system, especially if fume hoods are involved. Many options exist for controlling the airflow in a lab such as volumetric flow monitoring or pressure monitoring. No matter what control scheme is used, the author stresses the importance of accuracy in the sensors. Sensors with poor accuracy can dramatically alter the flow rates in and out of the lab, which can not only cause poor energy use, they can also cause a dangerous work environment for the occupants of the lab.

The EPA's Labs 21 initiative is designed to educate designers and owners of the energy impact of a laboratory building. EPA (2000) states that lab buildings can consume as much as 100 times the energy of a similar sized institutional or commercial building. This initiative stresses energy efficiency, renewable energy sources, and sustainable construction practices all while maintaining high standards of comfort health and safety. The EPA estimates that reducing half of the American laboratories' energy consumption by 30%, the nation can reduce its energy consumption by 84 trillion Btu. This would save \$1.25 billion annually and decrease carbon emissions by 19 million tons.

This publication outlines the basic issues behind a lab's energy consumption and summarizes key opportunities to improve the energy performance during the design and acquisition process.

### Chapter 3: The Model

The focus of this study is the Carver Co-Laboratory building. Building simulation software called TRANE TRACE 700 was used to model the building. This software was chosen because of its ability to predict annual energy usage of the mechanical and electrical systems of the building. TRACE is also one of the most commonly used software packages for analysis of this type. The construction details of this building were obtained from the blueprints from the architect. The input process to the software starts with dividing the building into a collection of zones.

TRACE treats every building as a collection of control volumes. In each control volume, the user needs to define the square footage of the space, along with the length and perpendicular direction of all exterior walls. The Carver Co-Lab is currently divided into 79 zones. Using the ductwork plans for the building, these 79 zones were input into the TRACE model.

TRACE then asks for the wall, floor, roof and ceiling details. These details were obtained from the wall and roof cross-section drawings from the building plans. Table 3.1 shows the layers and thickness of the above grade wall constructions and Table 3.2 shows the roof details.

Table 3.1 Above and Below Grade Wall Details

<b>Layer</b>	
Outside Surface Resistance	
4 inch Face Brick	
Air Space Resistance	
5/8" Gypsum Board	
6" Insulation	
5/8" Gypsum Board	
Inside Surface Resistance	
<b>Composite U-Value (Btu/hr-ft<sup>2</sup>-F)</b>	<b>0.0425</b>

Table 3.2 Roof and Ceiling Details

<b>Layer</b>	
Outside Surface Resistance	
0.5" Slag or Stone	
3/8" Felt and Membrane	
3.33" Insulation	
Steel Decking	
Inside Surface Resistance	
<b>Composite U-Value (Btu/hr-ft<sup>2</sup>-F)</b>	<b>0.0803</b>

Once the envelope parameters were defined, the windows and doors were input into the program. TRACE has an internal library of many window and door types. The type of windows and doors input into the program along with their U-Value and Shading Factor are shown in Table 3.3.

Table 3.3. Window and Door Details

<b>Window</b>	<b>U-Value (Btu/hr-ft<sup>2</sup>-F)</b>	<b>S.F.</b>
6mm Dbl Ref D Tint 6mm Air	<b>0.547</b>	<b>0.41</b>

After choosing the type of windows and doors, the glass surface area is input into the program for calculation purposes. This can be done by either giving the size and quantity of the windows, or giving the percentage of total wall area that is glass. Figure 3.1 shows a completed 3-D model of the building.

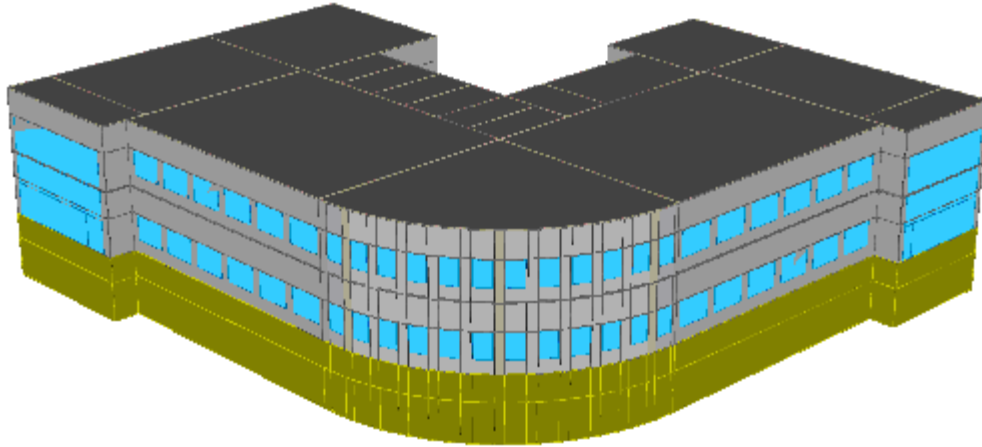

Figure 3.1 3-D view of the Building Model

#### *Occupancy – Lighting - Equipment*

In addition to the envelope details, TRACE asks for the occupancy, lighting, and miscellaneous loads of each space. To determine occupancy, each zone can be classified by its use, and TRACE uses default occupancy data to determine the sensible and latent heat gain due to the occupants of the building. In a similar manner, the classification of each zone will also give TRACE default lighting and equipment power densities. These default values can be modified to match the actual power densities of the building. In this study, the lighting power densities were left at default, but the equipment power densities were modified to more accurately reflect the energy use at Carver Co-Lab. Table 3.4 shows the occupancy, lighting and equipment power densities that were input into the program.



Table 3.4 Occupancy, Lighting and Equipment Power Densities for each Type of Zone

Room Type	Lighting (W/ft <sup>2</sup> )	Misc. Power (W/ft <sup>2</sup> )	People (ft <sup>2</sup> /person)
Commons	1	0.3	200
Conference	1	0.2	20
Electrical Room	1	2	0
Instrument Room	1.3	1	100
Lab Space	1.3	2	150
Lobby	1.3	0.3	200
Mechanical Room	1	0.5	0
Office Space	1.3	0.5	143

### *Schedules*

Scheduling is the procedure of telling the model when things are happening. For example, the lighting schedule tells the model at what times of the day the lights are on or off. This is done by assigning certain periods of the day with a certain percentage of the maximum load. When the lights are off, the percentage is zero, and when all the lights are on the percentage is 100, and so forth. All energy related inputs to the model have an assigned schedule associated with them. During the worst-case times of the year, also known as “design days”, the schedules are either at 100% or 0%. For the design cooling load calculation, it is common practice to assume that all electrical devices are on. For heating design calculations, it is common to assume that these are off. This allows for the installed capacity of the equipment to be large enough to handle the building loads during the most extreme times of year.

In order to create a model that will accurately predict the energy usage of a building, it is critical that the scheduling of the building’s equipment is accurate. This is a very important task, but it is also can be difficult. At Carver Co-Lab, some spaces have their ventilation rate determined by occupancy. This is accomplished by occupancy sensors. Therefore, to create an accurate ventilation schedule, the occupancy of the space must also be known. This can become difficult to quantify since people come and go continually throughout the day. Some schedules in a building are easy to obtain. In the case of the scheduling of the Energy Recovery Ventilators, these units are turned on at a certain time of year and run continuously until they are turned off at a different time.

A schedule is almost always made on assumptions, and so, the better the assumption, the better the model. For most schedules, an estimation of the load factor is made based on the average load during a period of time. In the case of lighting, lights are continuously being turned on and off by occupancy. An assumption can be made that on the average, 90 percent of the lights are on during the day, and they are all turned off at night. Assumptions similar to this one were made for all other scheduled items. The schedules of interest for this model include: lighting, occupancy, plug loads, ventilation, fume hoods, temperature, energy recovery and exhaust. Table 3.5 contains the assumed load factors for a few selected schedules, along with the cooling design day and heating design day assumptions.

Table 3.5 Load factors for Various Schedules

<i>Schedule</i>	<i>Occupied (7am to 7pm)</i>	<i>Unoccupied</i>	<i>Design Day Cooling</i>	<i>Design Day Heating</i>
Fume Hoods	100	20	100	100
Lighting and Equipment	90	0	100	0
Occupancy	90	0	100	0
Ventilation	90	60	100	0

### *Ventilation*

The difference between a laboratory building and other building types is its ventilation rate. Due the hazardous chemicals used, labs are typically 100% outdoor air systems, meaning they do not allow for the recirculation of any conditioned air. At Carver Co-Lab, the occupied ventilation rate is 10 Air Changes per Hour (ACH). The unoccupied rate is 6 ACH. In these spaces, over half of the energy needed to condition the space is due to its ventilation. From a modeling standpoint, this puts a lot of emphasis on the scheduling of the ventilation to ensure accuracy. This also demonstrates the importance of energy recovery from the exhaust streams.

TRACE allows each zone to specify the design ventilation air flow to the space, and also specify any room exhaust. The VAV minimum air flow rate is also input into TRACE. This is the minimum amount of air that must be supplied for the proper

ventilation and pressurization. The flow rates from each fume hood were found from the mechanical schedules. The VAV minimums were also found on the schedule block.

A few of the large lab spaces at Carver Co-Lab no longer have the ability to reduce their flow rate at unoccupied times. This was done because of the fear that the occupancy sensors would not be able to detect lab occupants working in certain portions of the lab. Therefore the ventilation schedule for these labs is different than the schedule for the smaller labs.

### *Energy Recovery*

The lab spaces at Carver Co-Lab have two forms of exhaust. One form is general building exhaust, and the other is fume hood exhaust. When the fume hoods are operating, dampers reduce the flow from the general exhaust to maintain pressurization, and vice versa. These two exhaust streams must be separated because the fume hood exhaust contains chemicals that require its ductwork to be made of stainless steel.

Currently, waste heat from the general building exhaust is being recovered by two ERV units. These units are sensible-only coil runaround loops. The heat recovered is transferred to the intake streams of Air Handlers 1 and 2. No heat is recovered from the fume hood exhaust. As stated earlier, the operation of the fume hoods has an effect on the amount of air flowing through the general building exhaust. With less air flowing through the general exhaust, less heat is available to be transferred to the intake air stream, and more energy is needed to condition the outside air.

### *Creating Systems*

The next portion of the input involves the creation of the systems that will control the temperature of the building. The Carver Co-Lab has three main types of HVAC equipment: (4) Air Handling Units, (5) Fan Coil Units and (2) Cabinet Unit Heaters. The air handling units are variable volume with reheat. These units serve the majority of building zones. The fan coil units serve the stairwells and a critical interior zone. The cabinet unit heaters are located at the entrances to the building and are heating only. A summary of the nine systems is given in Table 3.6. After specifying the type of units located in the building, TRACE is capable of calculating the fan energy usage from the

units. To do this, the type of fan and pressure drop through the air handling system is input to TRACE. With this information, TRACE can also calculate the additional fan heat that is generated from these fans, which must be handled by the coils. If this input is neglected, TRACE assumes that no energy is required to move air throughout the building, and there is no fan heat given to the space.

Table 3.6 Details of the Mechanical Equipment

<b>Equipment Name</b>	<b>Equipment Type</b>	<b>Locations Served</b>
AHU #1	Std. VAV w/ Reheat	Lab Spaces on 1st and 2nd Floor
AHU #2	Std. VAV w/ Reheat	Lab Spaces on 3rd Floor
AHU #3	Std. VAV w/ Reheat	Office Spaces on all Floors
AHU #4	Std. VAV w/ Reheat	Lab Spaces on 1st Floor
FCU #1	4-Pipe Fan Coil	North Upper Stairwell
FCU #2	4-Pipe Fan Coil	West Upper Stairwell
FCU #345	4-Pipe Fan Coil	3rd Floor Critical Zone
CUH #1	Heat-Only Cabinet Heater	North Lower Stairwell
CUH #2	Heat-Only Cabinet Heater	West Lower Stairwell

#### *Assigning Rooms to Systems*

The mechanical systems described above were assigned to their respective zones as described in the mechanical drawings. Figures 3.2 through 3.4 show the zoning of the three building floors along with the equipment that serves them.

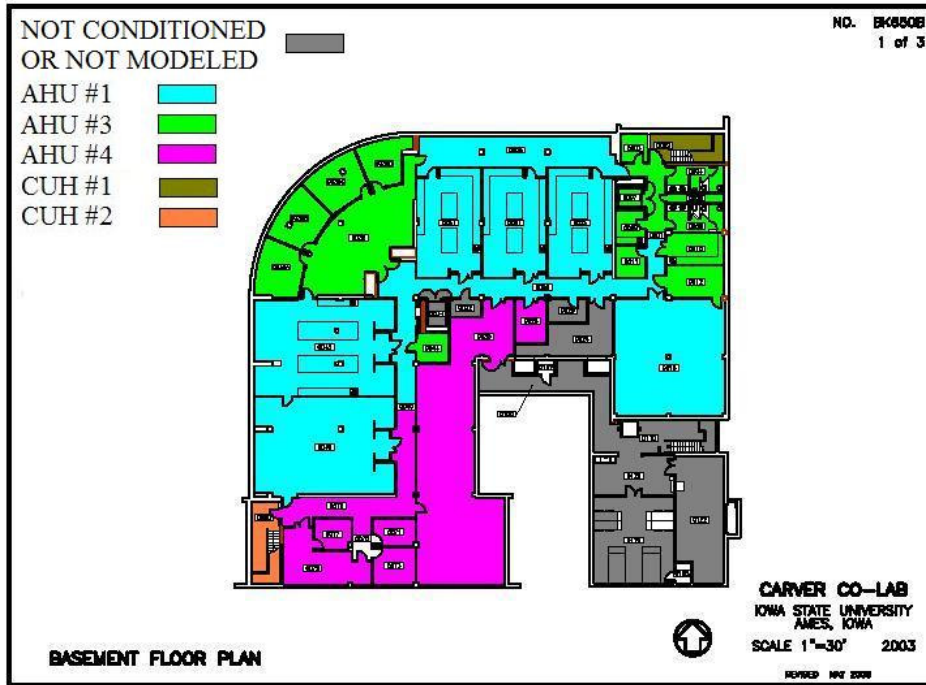

Figure 3.2 Mechanical Equipment Assigned to each Particular Zone

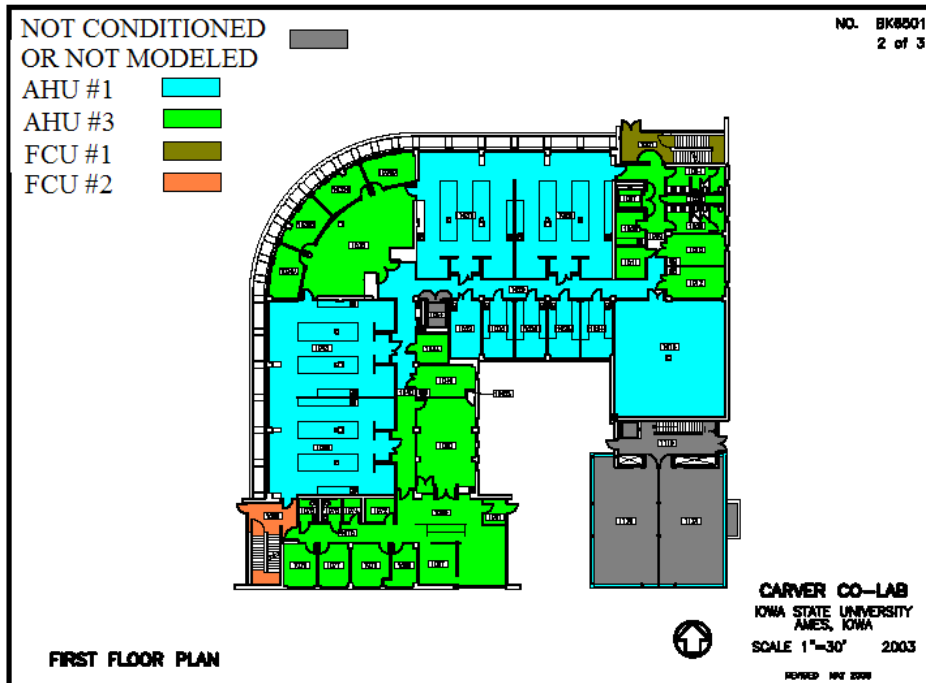

Figure 3.3 Mechanical Equipment Assigned to each Particular Zone

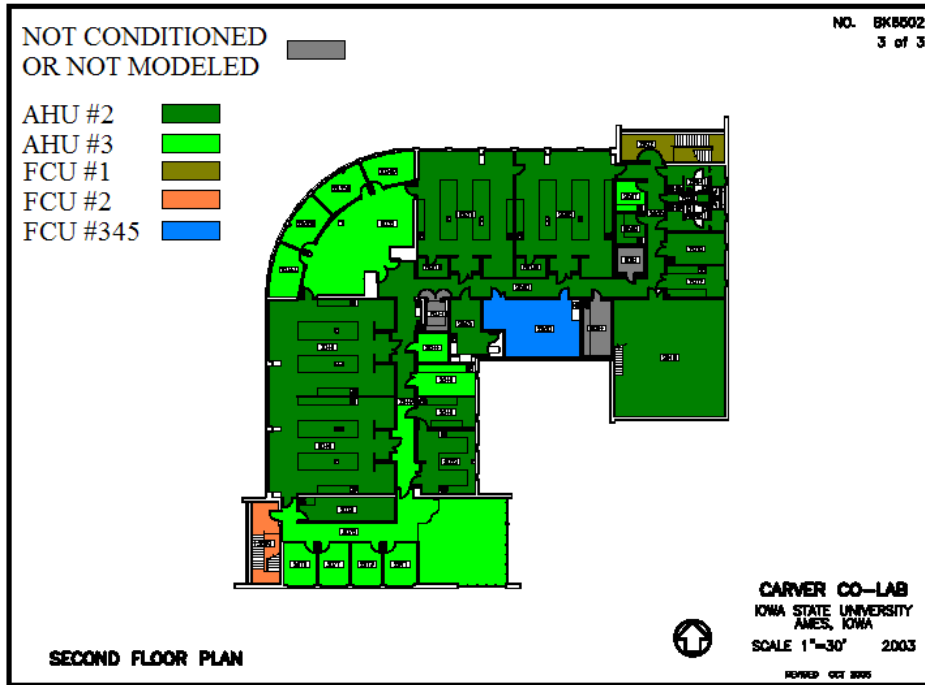

Figure 3.4 Mechanical Equipment Assigned to each Particular Zone

### *Creating Plants*

Once the rooms or zones have been assigned to a piece of mechanical equipment, the next step is to assign the heating and cooling coils to a plant. A plant represents the source of the heating or cooling medium. A cooling plant would contain the chiller(s) used to provide the chilled water that is circulated throughout the building. A heating plant would contain the hot water or steam boiler used for building circulation. Assigning the coils of the air handlers, fan coil units, and cabinet unit heaters to a plant gives the program information on what size of chillers and boilers the building will need to accommodate the building load. When the program knows the size of these units, it can calculate the energy requirements of them to show the electrical input consumptions of the units.

At CCL, the chilled water is piped into the building via the campus chilled water network. Therefore, there are no chillers or cooling towers located in the building. TRACE gives a purchased chilled water option for this particular situation. The program

does not add any electrical energy from cooling equipment to the total electrical consumption of the building. Even though there are no chillers in the building, TRACE requires that each cooling coil be assigned to a cooling plant. It will use this information to calculate the chilled water usage of the building. For heating, CCL has four boilers to make hot water for the coils. The heating coils are assigned to a heating plant, so TRACE can calculate boiler capacities, and show natural gas usage from them.

In addition to the chillers and boilers, TRACE also can calculate pump energy for the circulation of the heating and chilled water. In the case of CCL, the chilled water is pressurized coming into the building, and there is no pump in the building to circulate the chilled water. For the heating coils, heating water pumps are used to circulate water for the pre-heat and re-heat coils. To calculate the pump energy, the horsepower of the pumps is input into TRACE.

### *Economics*

TRACE has the ability to calculate annual and life cycle costs for a mechanical system. This can be used to determine the best mechanical system for a new building. For this study, the economics portion of the program is used to calculate the energy costs associated with chilled water usage, electrical usage, and natural gas usage. The marginal rates for these items were available from Iowa State University. Table 3.7 shows the marginal rates for natural gas, electricity, and chilled water.

Table 3.7 Marginal Rates for Natural Gas, Electricity, and Chilled Water

	<i>Electricity (\$/kWh)</i>	<i>Chilled Water (\$/Ton-hr)</i>	<i>Natural Gas (\$/therm)</i>
<b>Rate</b>	0.0706	0.1465	1.1

### *Simulating the Base Case*

This study will focus on improvements that can be made to laboratory building to reduce its energy use. To show the improvements, a reference point from which all other changes will be based needs to be simulated. This is known as the base case. The model

for the base case needs to be an accurate match to the actual building. In order to verify that the base case is accurate, actual data from the building will be compared to the results of the simulation. The first check to validate the model is comparing the installed capacity of the equipment with the calculated design day capacities of the equipment. Table 3.8 compares the predicted design day capacity of the mechanical equipment with actual installed capacity of the equipment.

Table 3.8 Comparison of TRACE Design Parameters to Installed System Capacities

<b>Installed Capacity</b>				
	Supply CFM	OA CFM	Total Capacity (Btu/hr)	Sensible Capacity (Btu/hr)
AHU #1	24500	24500	1849	1105
AHU #2	13500	13500	1077	638
AHU #3	18000	4000	1118	658
AHU #4	4820	1925	205	150
FCU #1	1350	0	53.6	41.1
FCU #2	1235	0	45	36.9
FCU #345	2870	0	104.4	73.9
<b>TRACE Design Parameters</b>				
	Supply CFM	OA CFM	Total Capacity (Btu/hr)	Sensible Capacity (Btu/hr)
AHU #1	24381	24388	1908	1088
AHU #2	13735	13727	1065	588
AHU #3	12932	3647	530	373
AHU #4	3057	1208	133	89
FCU #1	4572	0	67.5	66.4
FCU #2	2028	0	63.2	48
FCU #345	2095	0	17.7	15.5
<b>Percent Error</b>				
	Supply CFM	OA CFM	Total Capacity (Btu/hr)	Sensible Capacity (Btu/hr)
AHU #1	-0.5%	-0.5%	3.2%	-1.5%
AHU #2	1.7%	1.7%	-1.1%	-7.8%
AHU #3	-28.2%	-8.8%	-52.6%	-43.3%
AHU #4	-36.6%	-37.2%	-35.1%	-40.7%
FCU #1	238.7%	0.0%	25.9%	61.6%
FCU #2	64.2%	0.0%	40.4%	30.1%
FCU #345	-27.0%	0.0%	-83.0%	-79.0%

A comparison between the installed and modeled capacity shows whether or not the model has been input with the correct physical dimensions. For example, many of the lab spaces' ventilation rate is 10 ACH, which is ten times the volume of the space per



hour. Therefore, the ventilation rate of the model should match the scheduled ventilation rate if the dimensions of the building in the model are correct. Table 3.8 verifies that the capacities and flow rates for air handlers one and two are indeed accurate.

Air Handlers three and four contain office spaces mixed with lab spaces. Since these units are not 100% outside air loads, their capacities are dependent on the envelope, and the internal heat gains. From Table 3.8, it can be shown that the predicted maximum capacity for AHU 3 is much less than what is actually installed. This can be attributed to a number of things. Without knowing what the original designer was intending for each space on AHU 3, it is difficult to create a model that would match what was actually installed. The spaces on this air handler were modeled with common assumptions for lighting and miscellaneous loads. Some designers will add safety factors to their designs to allow the spaces to handle greater loads in the future. The TRACE output does not include any safety factors. Similarly, the Fan Coil Units are also shown to be different than the installed capacity. Without knowing what the engineer was given from the architect, it is difficult to create a model that matches the installed capacity. The fan coil units in the building represent a small amount of the chilled water usage, and therefore the error in these units will not be significant.

Of greater significance to this study is the actual energy usage of the building, not the design day installed capacity. Therefore, if the TRACE design capacity does not match the schedules, it does not mean that the model is inaccurate in its prediction of energy usage. It could mean that the designer of the building picked a coil that was bigger than necessary. Since Table 3.8 shows that the supply air quantities and ventilation flow rates for AHU 1 and 2 are a close match, it can be surmised that the physical dimensions of the model are accurate. Another way to validate the model is to compare the predicted annual energy usage with actual data from the building. In the case of CCL, the chilled water usage data is recorded every 15 minutes for billing purposes. By comparing the predicted chilled water usage with the actual chilled water usage, it can be shown that the model is accurate. Figure 3.5 shows the predicted chilled water usage along with the actual chilled water usage data. Natural gas is also recorded for billing purposes. This natural gas data can be compared to the predicted natural gas

usage of the building. Figure 3.6 shows the predicted natural gas usage along with the actual natural gas usage data.

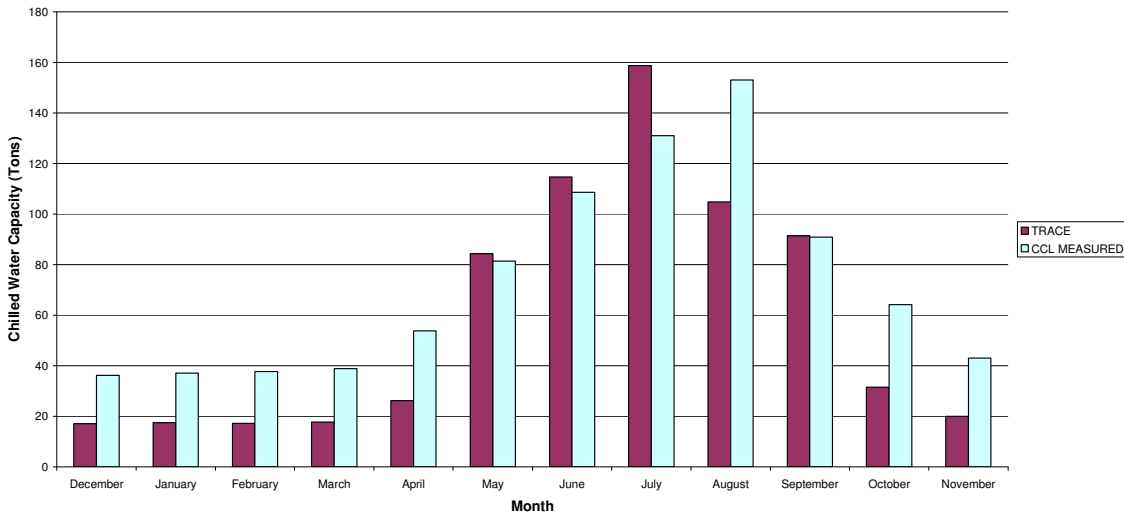

Figure 3.5 Predicted versus actual Chilled Water Usage

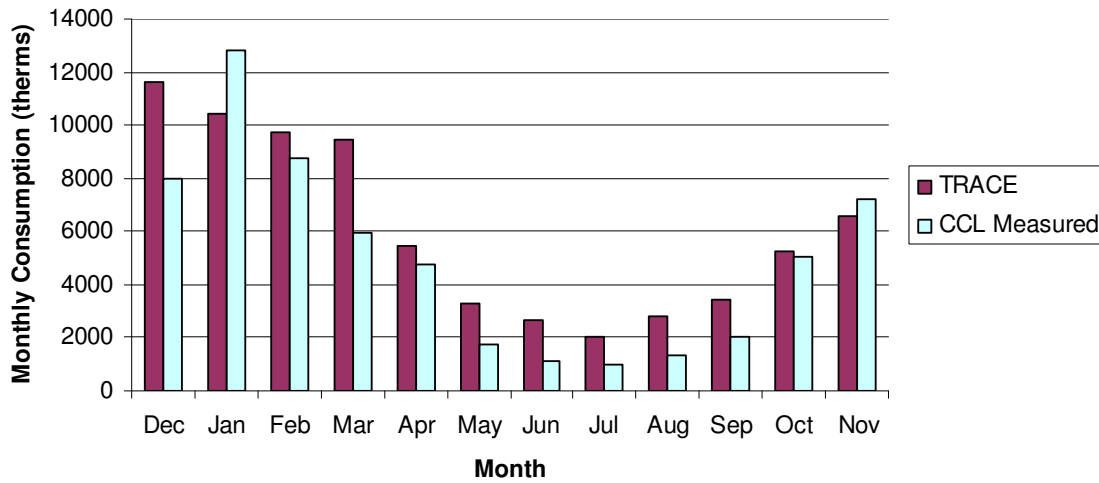

Figure 3.6 Predicted versus actual Natural Gas Usage

Several factors have an influence on the chilled water and natural gas usage of a building. Key factors include outdoor air temperature, relative humidity, and solar radiation. The model uses TMY2 data to calculate the loads on a building. The TMY2 data is a collection of monthly weather data for a specific year. A statistical analysis is

done on the weather data for each month of the last thirty years. Each month in the TMY2 data is assigned to a year that most closely represents the typical weather in the area. For example, it may have been determined that 1980's January weather data was the most representative of typical weather for January in the area. The January TMY2 data will then be a copy of the January 1980. The weather of 1991 could have been the most typical for February. The TMY2 data for February will then be a copy of the February 1991 data. Since the data is a collection of data from different years, they will most likely not match the actual weather data of a building. Noting these weather differences will help explain the discrepancies in the predicted and actual chilled water usage.

Plotting the measured average temperatures, humidity, and radiation against the predicted values, one can see how they match up. One would expect that even though the fluctuations in real data do not match with predicted data, on the average, they should be close. These plots can provide insight into why the model does not match with reality. Temperature, relative humidity and solar irradiation were measured directly at the Carver Co-Lab, and at the Energy Resource Station (ERS) in Ankeny, IA. Figure 3.7 shows the plot of the monthly averaged measured temperature versus the monthly averaged TMY2 temperature.



Figure 3.7 Average Measured Temperature vs. Average TMY2 Temperature

Similarly, this was done with the average total horizontal irradiation, and relative humidity. Carver Co-Lab did not have relative humidity data, so data from the neighboring Energy Resource Station in Ankeny, IA was used. Figure 3.8 shows the monthly averaged measured irradiation vs. the monthly averaged TMY2 irradiation. Figure 3.9 shows the monthly averaged measured relative humidity vs. the monthly averaged TMY2 humidity.

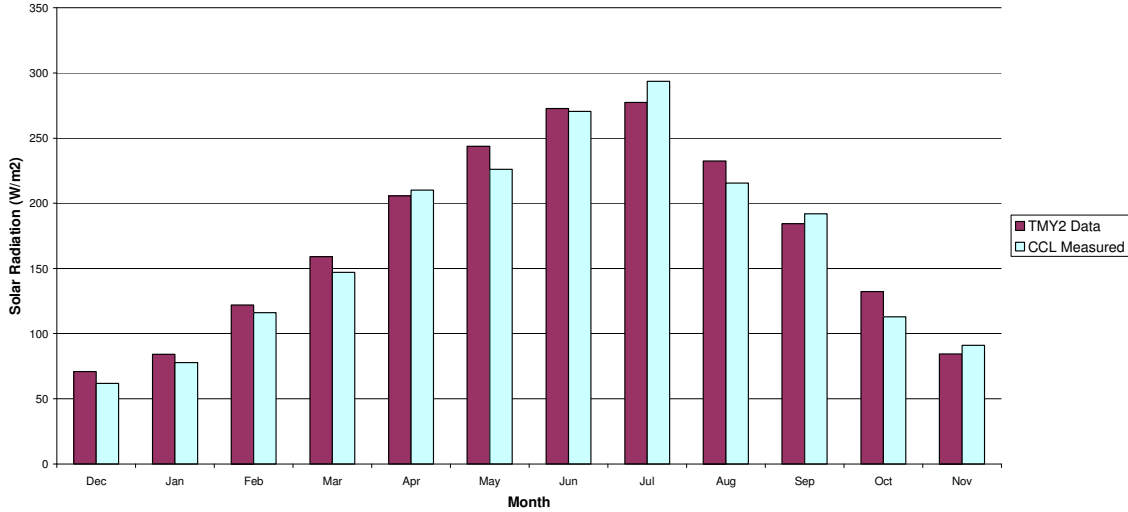

Figure 3.8 Average Measured Solar Irradiation vs. Average TMY2 Solar Irradiation

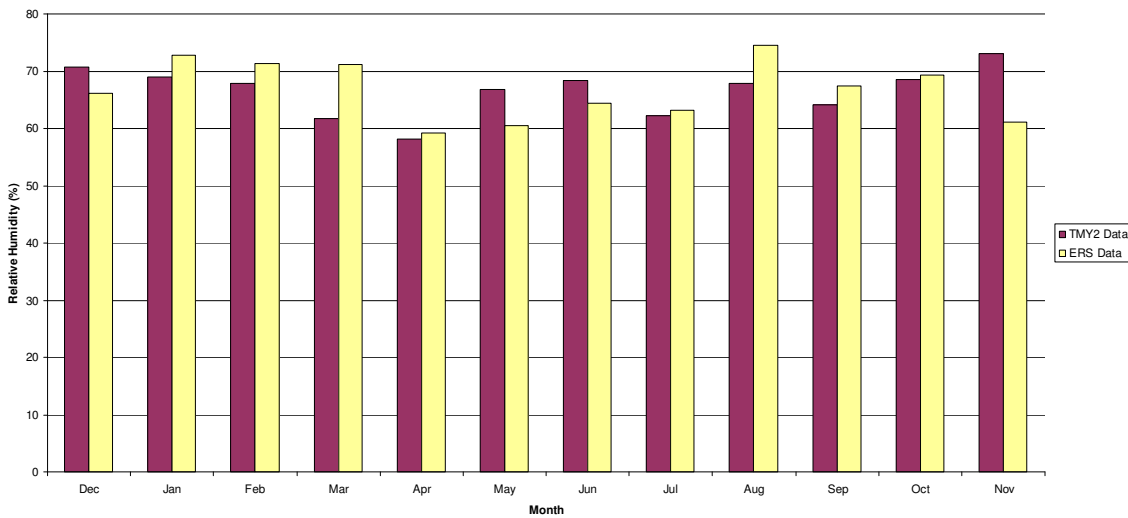

Figure 3.9 Average Measured Relative Humidity vs. Average TMY2 Relative Humidity

From these plots it is observable that the average measurements of the TMY2 data and the measured data follow the same trends throughout the year. It is also observable that they do not always match each other. On months with a higher actual outdoor air temperature, solar radiation or relative humidity than the predicted values, one would expect that the average chilled water usage in the building would be greater than what was predicted. Similarly, in winter months with colder average actual temperatures than

those predicted by the TMY2 data, one would expect the actual natural gas usage would be greater than what was predicted.

Weather has a large influence on the chilled water and natural gas usage, but it is not the only influence. Other things such as equipment, lighting, and occupancy schedules can have a major effect when chilled or heating water is needed. During some portions of the year, a certain schedule modeled in TRACE may not match the real situation at CCL. Creating a model that has every schedule that exactly matches reality would be an enormous task, and would be practically impossible due to the random nature of people and projects.

A model that exactly matches the real building is desirable, but if it does not, all hope is not lost. When comparing energy measures in a model, it is common to present the savings as a percentage of the base case. If the model contained an error, this error would be present in the base case, and also in the case it is compared to. Therefore, when displaying savings as a percentage, the errors from both cases cancel out, and the savings predicted in the model would match the savings in reality.

The TRACE model created for this study does not exactly match with the actual building usage. It is, however, a close representation of the energy use. Its monthly trends match the trends of the actual building, even though they are not identical. The installed capacity of the equipment is a close match to the predicted capacities. Differences in chilled water usage can be attributed to weather and the unpredictable use of the building that deviates from the schedule. Since the savings presented in this study will be on a percentage basis and since the model's prediction of chilled water use is relatively close to the actual usage, the results from this study can be assumed to be accurate.

The output tables from TRACE that are of interest to this study are the monthly heating and cooling demand tables, and the total annual energy use tables. Figures 3.10 and 3.11 show the average monthly heating and cooling demands of the building, respectively. Table 3.9 shows the total energy usage of the building including electricity, chilled water, and natural gas. Figure 3.12 gives a graphical pie chart of the energy usage.

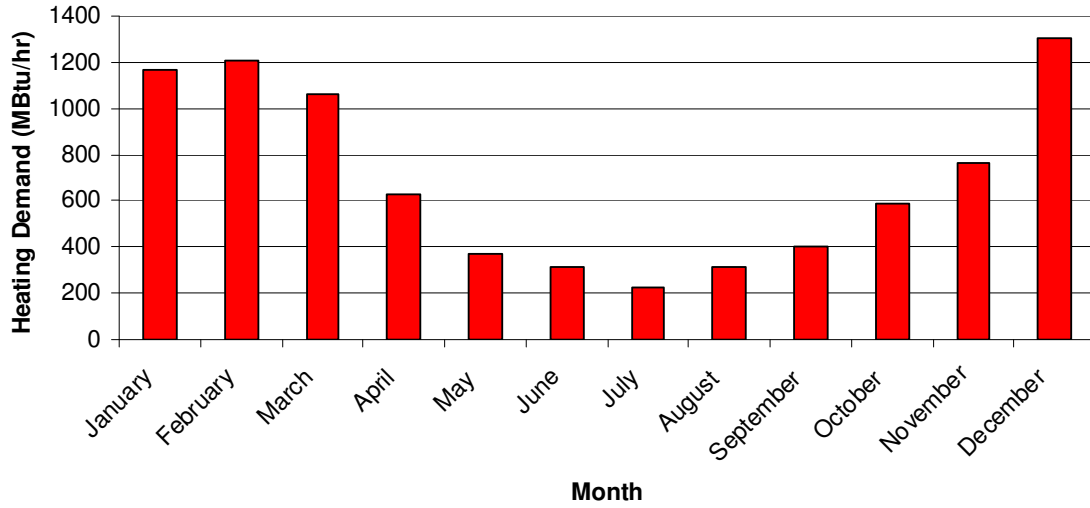

Figure 3.10 Average Monthly Heating Demand Predicted by TRACE

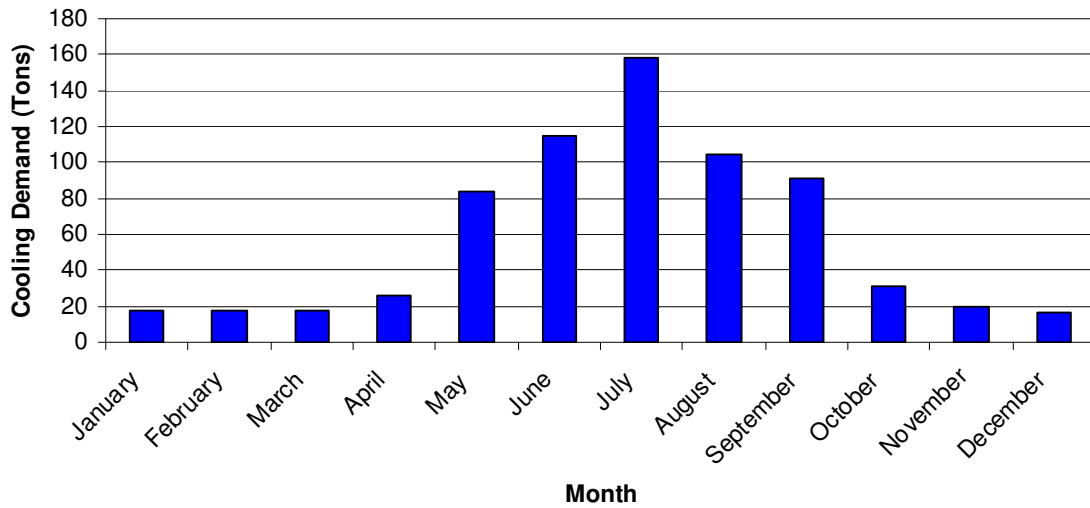

Figure 3.11 Average Monthly Cooling Demand Predicted by TRACE

Table 3.9 Annual Building Energy Use Predicted by TRACE

	<i>Electricity kWh</i>	<i>Gas kBtu</i>	<i>Chilled Water kBtu</i>
<b>Heating</b>	39,735	7,272,508	
<b>Cooling</b>	69,678		912,483
<b>Fans</b>	157,399		
<b>Pumps</b>	174,196		
<b>Lighting</b>	719,015		
<b>Receptacle</b>	203,457		
<b>Totals</b>	<b>1,363,480</b>	<b>7,272,508</b>	<b>912,483</b>
<b>Total Energy (kBtu)</b>	<b>12,838,546</b>		
<b>Total Source Energy (kBtu)</b>	<b>22,319,244</b>		

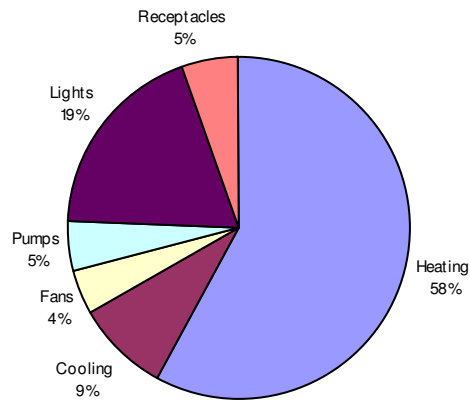

Figure 3.12 Annual Building Energy Use Predicted by TRACE



## Chapter 4: Energy Conservation Opportunities

With an accurate building energy simulation model, variations of building parameters can be performed to quantify potential energy conservation opportunities. The focus of this study was on the ventilation system because of its large energy impact to the building, and so a few items of interest were simulated. These items include: reducing the ventilation rate, installing enthalpy wheels and optimizing the heat recovery schedule.

### *Case 1: Reducing Ventilation Airflow and Fume Hood Exhaust*

In the previous chapter it was pointed out that the large laboratory spaces are 100% outdoor air systems, and no longer have the ability to reduce their air flow from 10 ACH to 6 ACH. This was because of the fear that the occupancy sensors would not see occupants in certain portions of the lab. Because of this situation, the air handling unit serving the lab is taking in 67% more outside air than it needs to during unoccupied times. The purpose of this simulation is to show the energy penalty associated with this situation. The Base model was simulated with the higher air change rate. The Case 1 model contains a change in the ventilation and VAV minimum schedule for the large lab spaces. Table 4.1 shows the change in schedules from this simulation and the Base Case.

The previous chapter also mentioned the fact that there is an airflow tradeoff between the general building exhaust and the fume hood exhaust. In order to keep the building adequately pressurized, the flow rates of air through the general building exhaust and the fume hood exhaust are constantly changing. When fume hood sashes open, more air is drawn through its ductwork, and less is drawn through the general building exhaust. The energy penalty for this situation comes from the heat recovery units. The heat recovery units are only located on the general building exhaust, and therefore if less air is moving through the ductwork, less heat is available to be transferred to the intake air stream. With less heat recovery, more energy is needed to condition the intake air stream.

After talking with building personnel, it was observed that the occupants of the lab spaces do not do a good job of closing the fume hood sashes when they are not in use. The fume hood sashes are commonly left at the maximum position, which requires the

most air flow. The Base model was simulated with the fume hood sashes open 100% of the time during occupied hours. The Case 1 model has a modified fume hood schedule which assumes the sashes are open 50% of the time during occupied hours. Table 4.1 shows the modified fume hood schedules from the Base Case.

Table 4.1 Schedule Changes for the Case 1 Simulation

<i>Schedule</i>	<i>Base Case</i>		<i>Case 1</i>	
	<i>Occupied</i>	<i>Unoccupied</i>	<i>Occupied</i>	<i>Unoccupied</i>
<b>Ventilation</b>	10 ACH	10 ACH	10 ACH	6 ACH
<b>Fume Hoods</b>	100% Flow	20% Flow	50% Flow	20% Flow

The results from this simulation show that energy savings can be found if these changes are implemented. Figures 4.1 and 4.2 are plots of the average monthly heating and cooling demand, respectively for both the Case 1 and Base Case models. Table 4.2 shows the total energy savings associated with these measures. Table 4.3 shows the cost savings attributed from the energy savings.

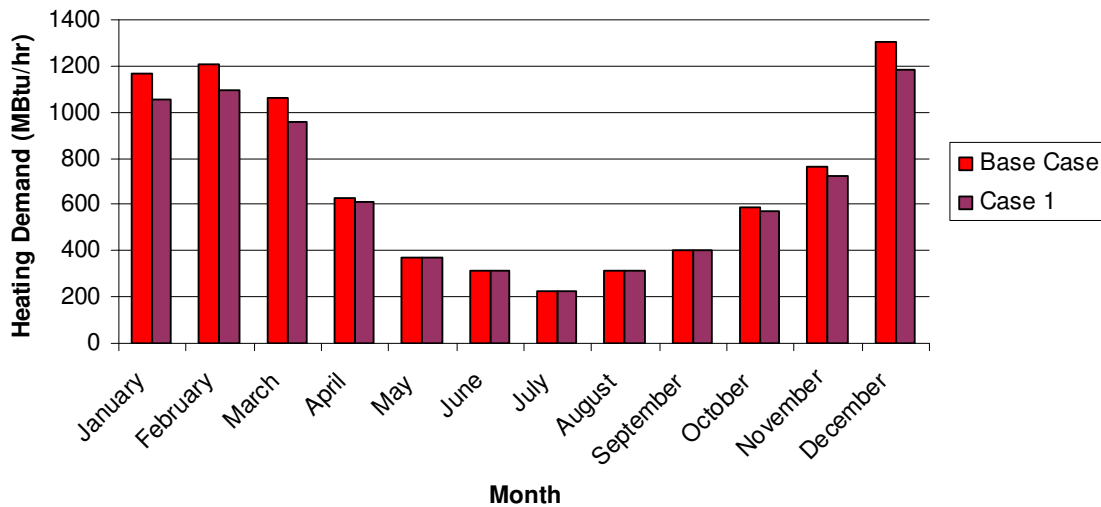

Figure 4.1 Average Monthly Heating Demand for Case 1 and the Base Case

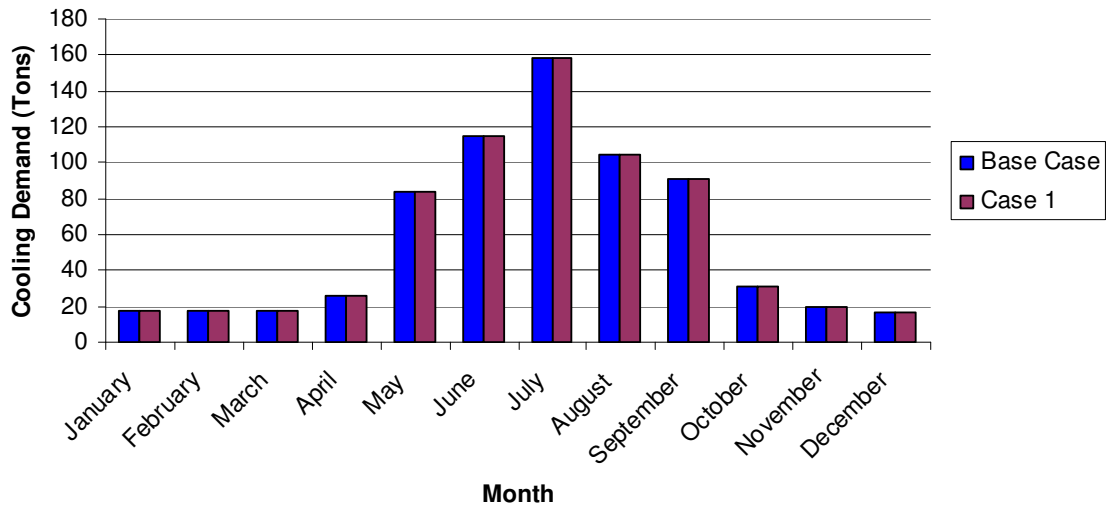

Figure 4.2 Average Monthly Cooling Demand for Case 1 and the Base Case

Table 4.2 Annual Energy Savings with Case 1

	<i>Electricity kWh</i>	<i>Gas kBtu</i>	<i>Chilled Water kBtu</i>
<b>Heating</b>	0	447,941	0
<b>Cooling</b>	0	0	-31
<b>Fans</b>	47	0	0
<b>Pumps</b>	0	0	0
<b>Lighting</b>	0	0	0
<b>Receptacle</b>	0	0	0
<b>Totals</b>	<b>47</b>	<b>447,941</b>	<b>-31</b>
<b>Total Energy (kBtu)</b>	<b>448,070</b>		
<b>Total Source Energy (kBtu)</b>	<b>471,974</b>		

Table 4.3 Annual Cost Savings with Case 1

	<i>Electricity</i>	<i>Gas</i>	<i>Chilled Water</i>
<b>Heating</b>	\$0	\$4,927	\$0
<b>Cooling</b>	\$0	\$0	\$0
<b>Fans</b>	\$3	\$0	\$0
<b>Pumps</b>	\$0	\$0	\$0
<b>Lighting</b>	\$0	\$0	\$0
<b>Receptacle</b>	\$0	\$0	\$0
<b>Totals</b>	<b>\$3</b>	<b>\$4,927</b>	<b>\$0</b>
<b>Total Energy (kBtu)</b>	<b>\$4,930</b>		

The total energy savings shown in Table 4.2 is 3.5% of the total energy used in the Base model. The cost savings of \$4,930 can be realized with very minor implementation cost. Simply fixing the occupancy sensors and training the researchers about fume hood sashes is all that is needed to implement these measures. Looking at Figure 4.2, it is clear that there is no observable change in the cooling energy used annually. This is most likely due to the fact the energy recovery unit does not run during the summer months. Therefore, an increase in general building exhaust flow would have no impact on chilled water usage. Also, a reduction in the ventilation rate for the lab spaces has little effect on the chilled water usage. This is because the ventilation rate only turns down when the space is unoccupied. This occurs usually during the evening hours, and less energy is needed to condition the air at that time.

It was observable from Figure 4.1 that a reduction in heating energy can be realized by these measures. Reducing the fume hood air flow increases the flow through the heat recovery wheel, and therefore reduces the energy input to the intake airstream. Allowing the lab spaces to reduce their ventilation rate in the evenings decreases the amount of energy needed to heat the incoming air. These measures are the most simple and least expensive to implement, and so, they will be included in each additional Case.

### Case 2: Enthalpy Wheel

Carver Co-Lab currently utilizes two sensible only run-around loops to recover heat from the general building exhaust. Figure 4.3 shows a diagram of a run-around loop system. Air handlers 1 and 2 recover the waste heat from the exhaust streams. Air Handlers 3 and 4 do not incorporate heat recovery. The run-around loops currently used only recover the sensible portion of the exhaust stream. Installing an enthalpy wheel would allow for the recovery of both sensible and latent energy. For a building with a high ventilation rate such as this one, significant energy savings, may exist from this installation. To create this model, the choice of heat recovery unit is given in a drop down menu for each air handler. TRACE uses default values for the sensible and latent effectiveness for the enthalpy wheels. These inputs can be modified if desired. Figure 4.4 shows a diagram of an enthalpy wheel. An enthalpy wheel has a larger size than a run-around loop, and so the pressure drop through the enthalpy wheel is increased. There is also electrical input energy to spin the enthalpy wheel. TRACE accounts for these increased costs in its simulation. Figures 4.5 and 4.6 show the average monthly heating and cooling demand, respectively for Case 2 and the Base Case. Table 4.4 shows the annual energy savings due to these measures. Table 4.5 shows the cost savings attributed from the energy savings.

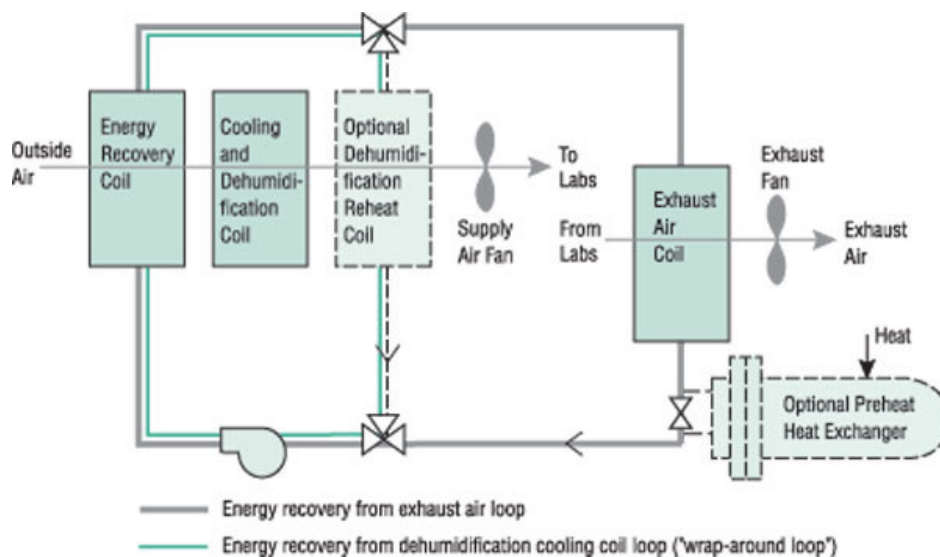

Figure 4.3 Diagram of Run-Around Loop

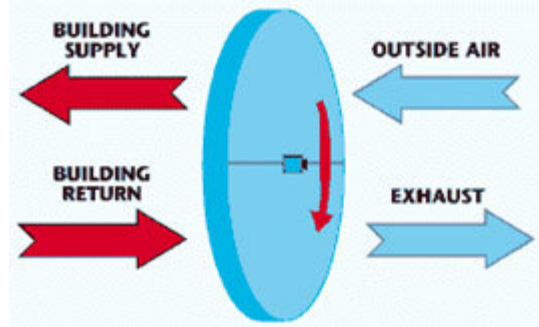

Figure 4.4 Diagram of Enthalpy Wheel

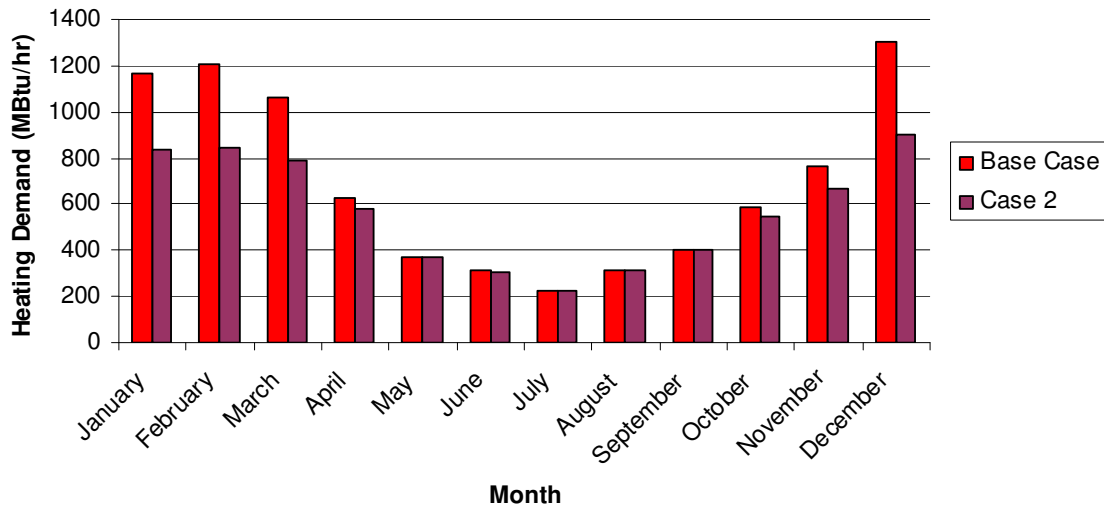

Figure 4.5 Average Monthly Heating Demand for Case 2 and the Base Case

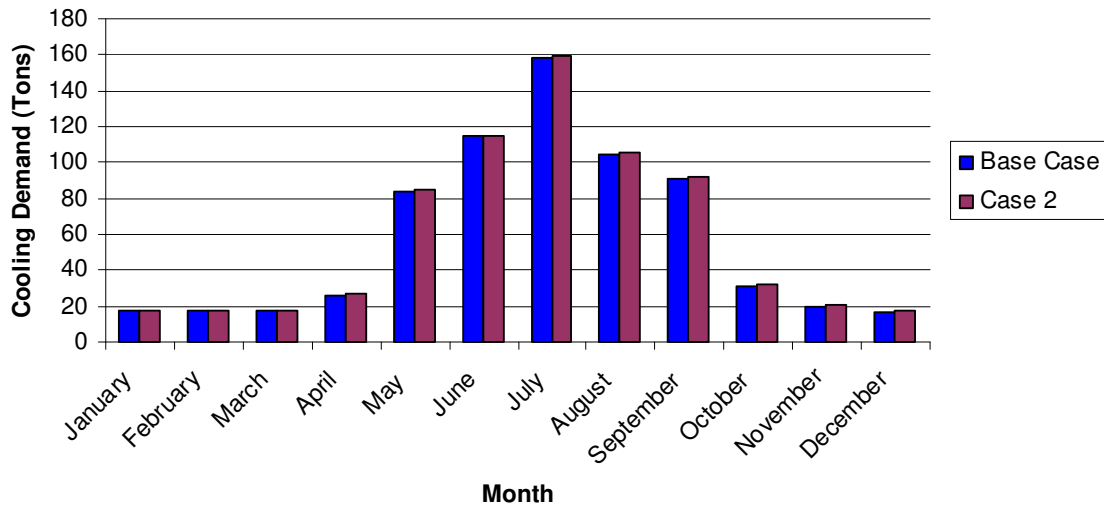

Figure 4.6 Average Monthly Cooling Demand for Case 2 and the Base Case

Table 4.4 Annual Energy Savings with Case 1

	<i>Electricity kWh</i>	<i>Gas kBtu</i>	<i>Chilled Water kBtu</i>
<b>Heating</b>	2	1,353,048	0
<b>Cooling</b>	0	0	-7,005
<b>Fans</b>	-645	0	0
<b>Pumps</b>	0	0	0
<b>Lighting</b>	0	0	0
<b>Receptacle</b>	0	0	0
<b>Totals</b>	<b>-643</b>	<b>1,353,048</b>	<b>-7,005</b>
<b>Total Energy (kBtu)</b>	<b>1,329,997</b>		
<b>Total Source Energy (kBtu)</b>	<b>1,370,732</b>		

Table 4.5 Annual Cost Savings with Case 1

	<i>Electricity</i>	<i>Gas</i>	<i>Chilled Water</i>
<b>Heating</b>	\$0	\$14,884	\$0
<b>Cooling</b>	\$0	\$0	-\$85
<b>Fans</b>	-\$46	\$0	\$0
<b>Pumps</b>	\$0	\$0	\$0
<b>Lighting</b>	\$0	\$0	\$0
<b>Receptacle</b>	\$0	\$0	\$0
<b>Totals</b>	<b>-\$45</b>	<b>\$14,884</b>	<b>-\$85</b>
<b>Total Savings</b>	<b>\$14,753</b>		

The total energy savings shown in Table 4.4 is 10.39% of the annual energy consumption of the Base model for an energy savings of \$14,753. The enthalpy wheels add an additional 6.9% to the Case 1 energy savings. From Figure 4.5, it is observable that the energy savings are due to the reduction in heating energy. This reduction comes from the fact that the enthalpy wheels recover a larger portion of the available energy in the exhaust stream. It is also notable that there is an increased amount of fan energy with this measure. This increased cost is small in comparison to the savings accrued from natural gas savings. Table 4.4 shows that no savings in cooling energy was achieved

with this measure. This is because the units are turned off during the summer months. If these units were run during the summer, energy from the cool airstream could be recovered. Case 5 will examine the effects of running the energy recovery units all year long.

*Case 3: Adding Enthalpy Wheels to AHU's 3 and 4*

It was mentioned in the previous Case that Air Handlers 3 and 4 do not recover waste energy from their exhaust streams. Incorporating enthalpy wheels on these units would reduce the outside air conditioning energy currently being used. Case 3 is a continuation of Cases 1 and 2. This Case equips Air Handlers 3 and 4 with enthalpy wheels. Figures 4.7 and 4.8 show the average monthly heating and cooling demand, respectively for Case 3 and the Base Case. Table 4.6 shows the annual energy savings due to these measures. Table 4.7 shows the cost savings attributed from the energy savings.

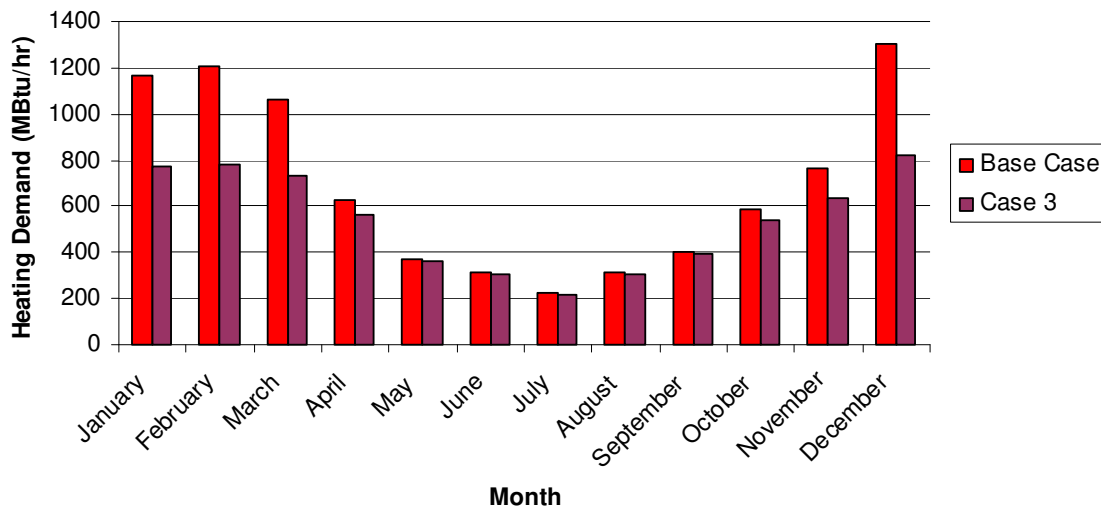

Figure 4.7 Average Monthly Heating Demand for Case 3 and the Base Case



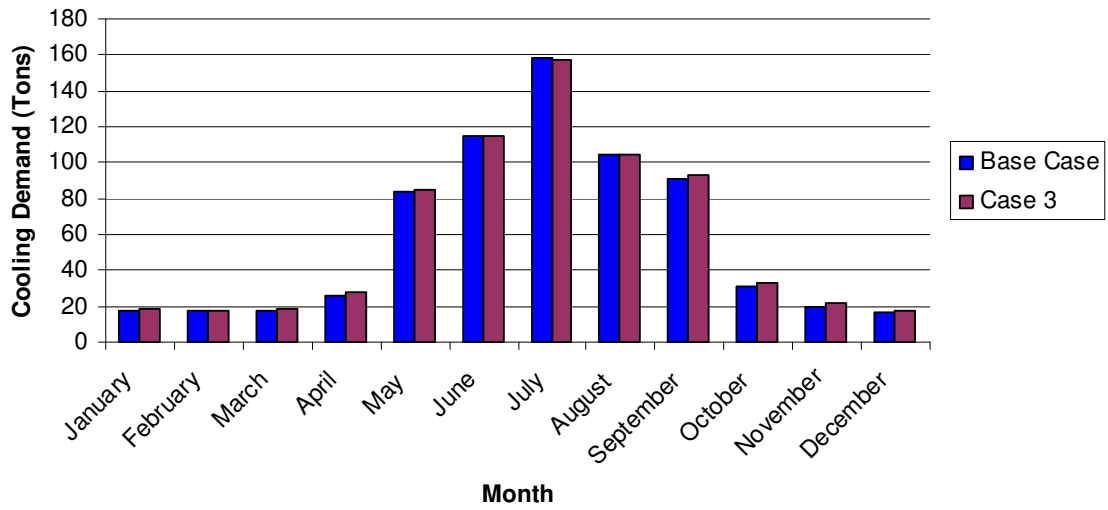

Figure 4.8 Average Monthly Cooling Demand for Case 3 and the Base Case

Table 4.6 Annual Energy Savings with Case 3

	<i>Electricity kWh</i>	<i>Gas kBtu</i>	<i>Chilled Water kBtu</i>
<b>Heating</b>	1,898	1,648,004	0
<b>Cooling</b>	0	0	-10,559
<b>Fans</b>	-11,828	0	0
<b>Pumps</b>	0	0	0
<b>Lighting</b>	0	0	0
<b>Receptacle</b>	-11,066	0	0
<b>Totals</b>	<b>-20,996</b>	<b>1,648,004</b>	<b>-10,559</b>
<b>Total Energy (kBtu)</b>	<b>1,565,781</b>		
<b>Total Source Energy (kBtu)</b>	<b>1,511,606</b>		

Table 4.7 Annual Cost Savings with Case 3

	<i>Electricity</i>	<i>Gas</i>	<i>Chilled Water</i>
<b>Heating</b>	\$134	\$18,128	\$0
<b>Cooling</b>	\$0	\$0	-\$129
<b>Fans</b>	-\$835	\$0	\$0
<b>Pumps</b>	\$0	\$0	\$0
<b>Lighting</b>	\$0	\$0	\$0
<b>Receptacle</b>	-\$781	\$0	\$0
<b>Totals</b>	-\$1,482	\$18,128	-\$129
<b>Total Savings</b>	<b>\$16,517</b>		

The energy savings from these measures amount to 12.2% of the current energy consumption. These measures add 1.8% of energy savings to the Case 1 and Case 2 energy savings. The total cost savings from these measures is \$16,517. It is observable from Figures 4.7 and 4.8 that the energy savings are primarily due to a reduction in heating energy. No reductions in cooling energy are observable because the units are turned off during the summer months. Similarly to Case 2, increases in fan and receptacle energy represent increased costs that deduct from the savings.

#### *Case 4: Recover Energy from Fume Hood Exhaust*

The first three Cases involve the capturing of waste energy in the general building exhaust. Waste energy is also present in the fume hood exhaust. This exhaust is separated due to the fact that the chemicals present in the exhaust require stainless steel ductwork. If heat was to be recovered from this exhaust, a sensible only heat exchanger would be required for fear of cross-contamination with the intake air stream. Case 4 includes a sensible only run-around loop to recover waste heat from the fume hood exhaust. Air handlers one and two serve lab spaces with fume hoods. The heat recovered from the fume hoods would be in addition to heat already being recovered from the general building exhaust. An additional pressure drop would be added for this coil and so an increase in fan energy is expected. Figures 4.9 and 4.10 show the average monthly heating and cooling demand, respectively for Case 4 and the Base Case. Table 4.8 shows

the annual energy savings due to these measures. Table 4.9 shows the cost savings attributed from the energy savings.

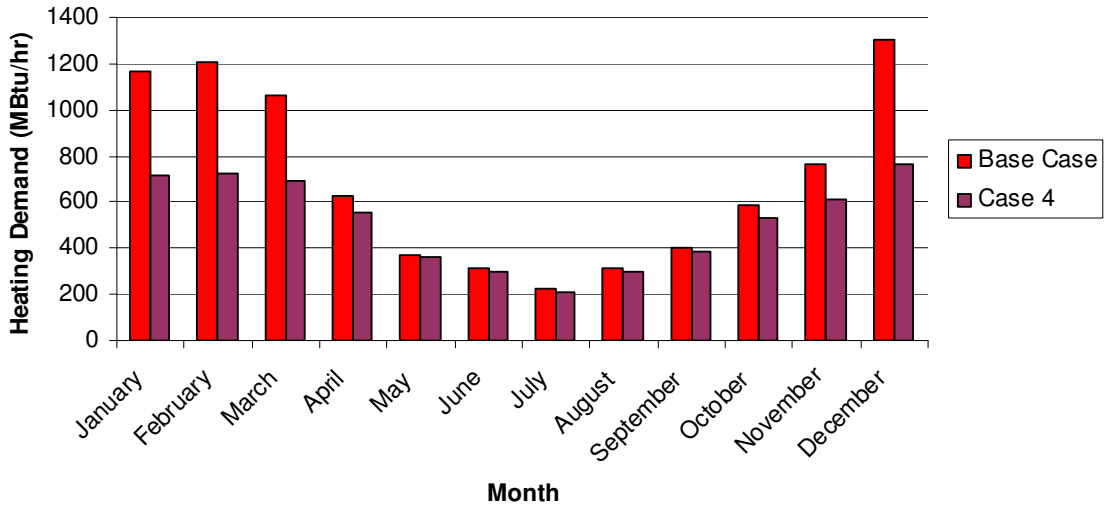

Figure 4.9 Average Monthly Heating Demand for Case 4 and the Base Case

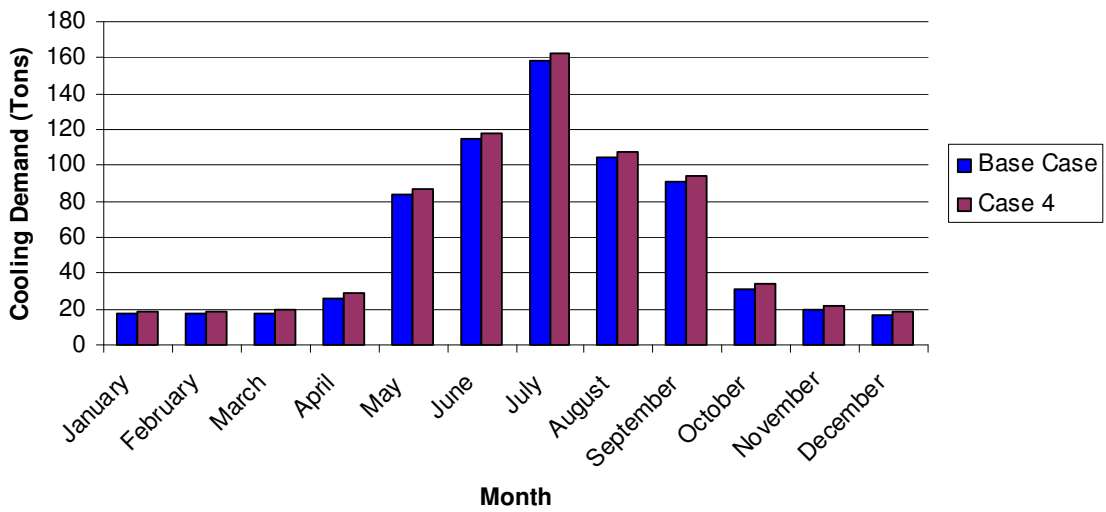

Figure 4.10 Average Monthly Cooling Demand for Case 4 and the Base Case

Table 4.8 Annual Energy Savings with Case 4

	<i>Electricity kWh</i>	<i>Gas kBtu</i>	<i>Chilled Water kBtu</i>
<b>Heating</b>	-9	1,904,780	0
<b>Cooling</b>	0	0	-36,076
<b>Fans</b>	-13,086	0	0
<b>Pumps</b>	0	0	0
<b>Lighting</b>	0	0	0
<b>Receptacle</b>	-8,129	0	0
<b>Totals</b>	<b>-21,224</b>	<b>1,904,780</b>	<b>-36,076</b>
<b>Total Energy (kBtu)</b>	<b>1,796,265</b>		
<b>Total Source Energy (kBtu)</b>	<b>1,759,942</b>		

Table 4.9 Annual Cost Savings with Case 4

	<i>Electricity</i>	<i>Gas</i>	<i>Chilled Water</i>
<b>Heating</b>	-\$1	\$20,953	\$0
<b>Cooling</b>	\$0	\$0	-\$440
<b>Fans</b>	-\$924	\$0	\$0
<b>Pumps</b>	\$0	\$0	\$0
<b>Lighting</b>	\$0	\$0	\$0
<b>Receptacle</b>	-\$574	\$0	\$0
<b>Totals</b>	<b>-\$1,498</b>	<b>\$20,953</b>	<b>-\$440</b>
<b>Total Savings</b>	<b>\$19,014</b>		

The energy savings from these measures amount to 14% of the current energy consumption. The Case 4 measures add 1.8% of energy savings to the savings of Cases 1, 2 and 3. The total cost savings from these measures is \$19,014. It is observable from Figures 4.9 and 4.10 that the energy savings are primarily due to a reduction in heating energy. No reductions in cooling energy are observable because the units are turned off during the summer months. Similarly to the other Cases, increases in fan and receptacle energy represent increased costs that deduct from the savings. Incorporating a heat

recovery system that would capture the latent portion of the energy and yet prohibit cross-contamination between the air streams would be the best option for this situation.

*Case 5: Utilize Year-Round Energy Recovery*

In the previous Cases that dealt with heat recovery, it was observed that no energy savings in cooling energy were realized due to the fact the units were turned off during the summer. This final simulation shows the benefit of running the heat recovery units year-round. This simulation is built off the other four Cases. It includes enthalpy wheels on the four air handling units and run-around loops on the fume hood exhaust streams. These units are scheduled for use year-round. Figures 4.11 and 4.12 show the average monthly heating and cooling demand, respectively for Case 5 and the Base Case. Table 4.10 shows the annual energy savings due to these measures. Table 4.11 shows the cost savings attributed from the energy savings.

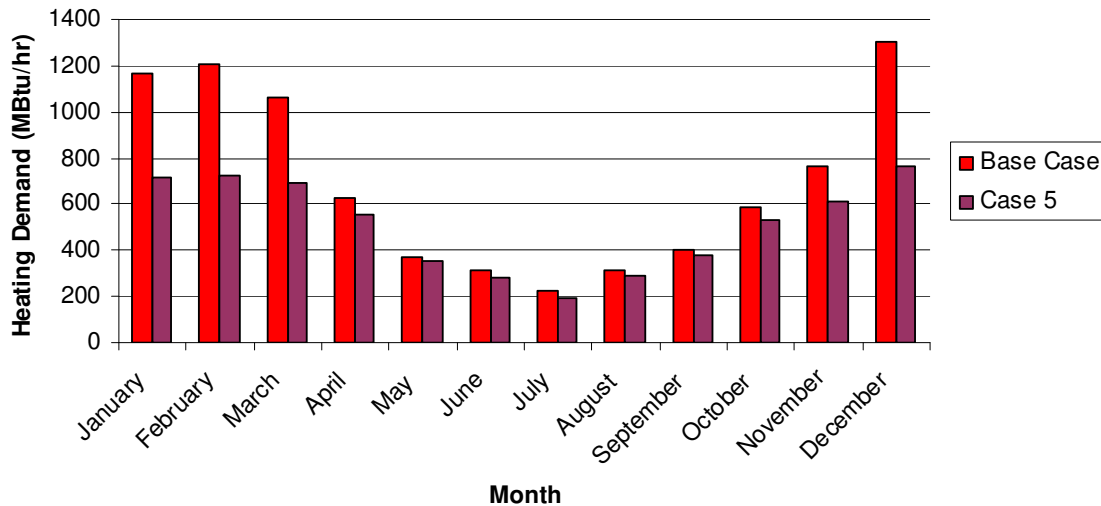

Figure 4.11 Average Monthly Heating Demand for Case 5 and the Base Case

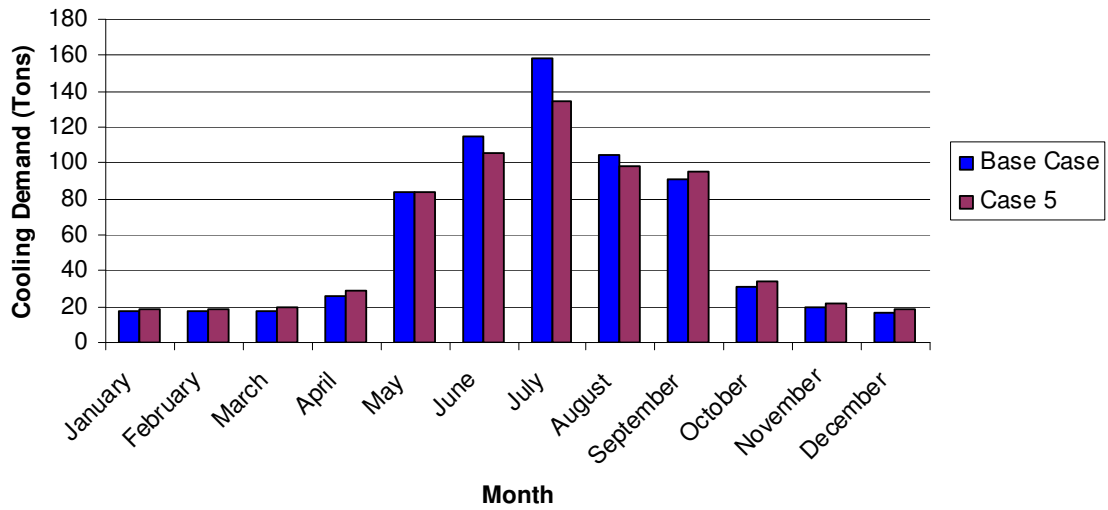

Figure 4.12 Average Monthly Cooling Demand for Case 5 and the Base Case

Table 4.10 Annual Energy Savings with Case 5

	<i>Electricity kWh</i>	<i>Gas kBtu</i>	<i>Chilled Water kBtu</i>
<b>Heating</b>	16,713	1,954,044	0
<b>Cooling</b>	0	0	33,071
<b>Fans</b>	-22,446	0	0
<b>Pumps</b>	0	0	0
<b>Lighting</b>	0	0	0
<b>Receptacle</b>	-14,004	0	0
<b>Totals</b>	<b>-19,737</b>	<b>1,954,044</b>	<b>33,071</b>
<b>Total Energy (kBtu)</b>	<b>1,919,749</b>		
<b>Total Source Energy (kBtu)</b>	<b>1,880,210</b>		

Table 4.11 Annual Cost Savings with Case 5

	<i>Electricity</i>	<i>Gas</i>	<i>Chilled Water</i>
<b>Heating</b>	\$1,180	\$21,494	\$0
<b>Cooling</b>	\$0	\$0	\$403
<b>Fans</b>	-\$1,585	\$0	\$0
<b>Pumps</b>	\$0	\$0	\$0
<b>Lighting</b>	\$0	\$0	\$0
<b>Receptacle</b>	-\$989	\$0	\$0
<b>Totals</b>	<b>-\$1,393</b>	<b>\$21,494</b>	<b>\$403</b>
<b>Total Savings</b>	<b>\$20,505</b>		

The energy savings from these measures amount to 14.95% of the current energy consumption. The Case 5 changes add 0.95% of energy savings to the savings of Cases 1 through 4. The total cost savings from these measures is \$20,505. It is observable from Figures 4.11 and 4.12 that the energy savings are now due to both a reduction in heating and cooling energy. Similarly to the other Cases, increases in fan and receptacle energy represent increased costs that deduct from the savings. The reasoning behind turning off the energy recovery units during the summer months is the very small benefit for doing so. The small temperature difference between the airstreams limits the available amount of energy that is transferable from one air stream to another. Albeit small, benefit would be realized from running the energy recovery units annually. Table 4.12 is a summary of the energy and cost savings for each Case in this chapter. Figures 4.13 and 4.14 show a graphical summary of the results given in this chapter including energy reduction and cost savings.

Table 4.12 Summary of Energy and Cost Savings for Each Case

	<i>Energy Savings (kBtu/year)</i>	<i>Cost Savings (\$/year)</i>	<i>Percent Change</i>
<b>Case 1</b>	448,070	\$4,930	3.5
<b>Case 2</b>	881,927	\$9,823	6.9
<b>Case 3</b>	235,784	\$1,764	1.8
<b>Case 4</b>	230,484	\$2,497	1.8
<b>Case 5</b>	123,484	\$1,491	0.95
<b>Totals</b>	<b>1,919,749</b>	<b>\$20,505</b>	<b>14.95</b>

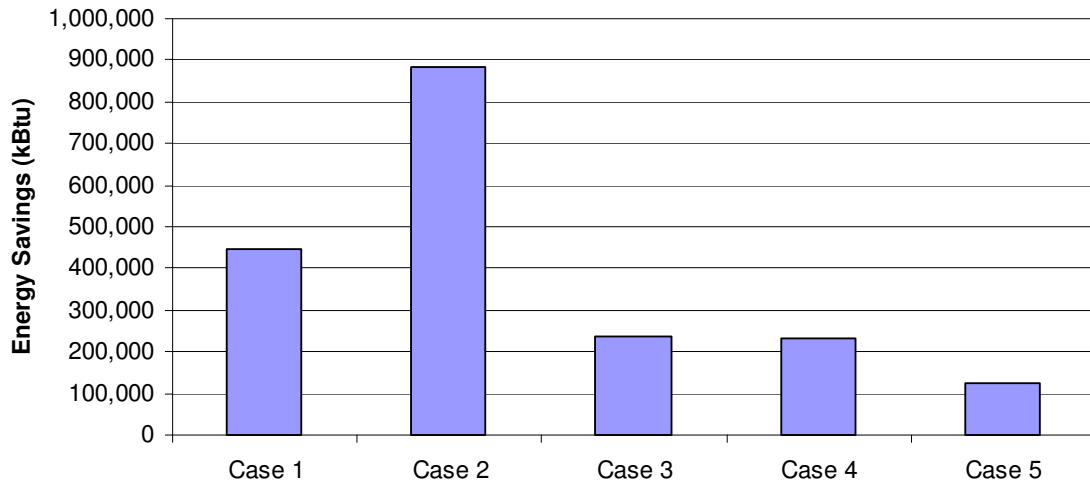

Figure 4.13 Summary of Proposed Energy Savings

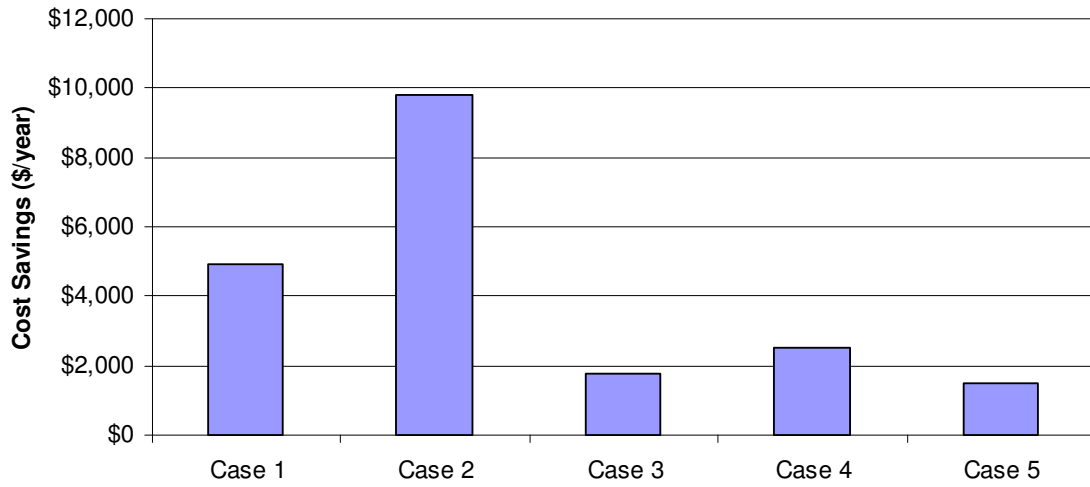

Figure 4.14 Summary of Proposed Cost Savings



## Chapter 5: Conclusions

This study was comprised of five cases ranging from very small capital investment to very large investment. The purpose of the study was not to propose the actual installation of new equipment in Carver Co-Lab, but to guide the future design of laboratory buildings. It would not be practical to retrofit Carver Co-Lab with new ductwork and enthalpy wheels with the cost savings suggested in this study. It does, however, make sense to incorporate these ideas in the design of a new laboratory building. Carver Co-Lab can take advantage of the Case 1 measures due their low implementation cost. The modification of the occupancy sensors and the training of employees on the proper use of fume hoods are both simple things that can be done to minimize the energy use of the building.

In future lab building designs, enthalpy wheels should be incorporated because of their ability to recover both the sensible and latent portions of the exhaust stream energy. Enthalpy wheels should be used on all air handlers, not just the lab air handlers because benefit is available for all units that intake outside air. This requires that the ductwork be routed so the intake and exhaust streams are adjacent to one another. Due to the locations of the intake and exhaust in the existing building, it would be very expensive to retrofit the exhaust ductwork to incorporate enthalpy wheels.

New building designs should also consider the benefit from recovering the energy from the fume hood exhaust. Due to the chemicals in the airstream, this exhaust must be separate from the general building exhaust. To recover this energy, sensible only recovery devices must be installed, which limits the energy savings that can be claimed by this measure. Depending on the implementation cost of this recommendation, this may or may not be a viable option.

The results of the Case 5 measure concluded that there was small benefit from running the energy recover units year-round. This simulation did not contain the base case equipment, and therefore the same conclusions can not be made for the existing equipment. The year round benefit to energy recovery comes from the capabilities of the enthalpy wheels. The dehumidification capabilities of the wheels allow for energy savings in the summer months that can outweigh the energy penalty of running the wheels. Since sensible-only devices cannot dehumidify the outside air stream, the benefit

to recovering the small amount of sensible energy does not justify increased expense of running the pumps in a run-around system.

This project set out to create a model of the Carver Co-Lab and all of its existing equipment. Five different perturbations of this model were created with an emphasis on the ventilation system. The first case involved the reduction in the ventilation rate during unoccupied times, along with improved operation of the fume hood sashes. The second simulation added enthalpy wheels to the lab air handling units. The third simulation added enthalpy wheel to the remaining units which serve office spaces. The fourth simulation showed the effect of recovering the fume hood exhaust, and the final simulation showed the benefit to running the energy recovery units year-long to maximize the energy savings potential.

Of all of these simulations, it was the addition of the enthalpy wheels to the lab air handling units that had the most energy savings potential. The savings from this measure also come with a high implementation cost. The measure with the lowest implementation cost was the Case 1 simulation. This recommendation would have a very quick payback since it would be so cheap to implement. The other cases all have the potential for energy savings, but their implementation cost would not justify a retrofit of existing equipment. The results of this study can help guide the design of new lab buildings, so that the energy spent on ventilation is minimal.

## References

Brown, W.K., 1996, Laboratory Design Loads—What We Know, Don't Know, and Need to Know, *ASHRAE Transactions*, AT-96-9-1 v.102 No.1: 711-722

Brown, W.K., 1996, Application of Evaporative Cooling to Large HVAC Systems, *ASHRAE Transactions*, AT-96-14-3 v.102 No.1: 895-907

Mathew, P., Greenberg, S., Sartor, D., Frenze, D., Morehead, M., Starr, W., 2005, *Heating Piping and Air Conditioning Engineering*, September Pt.1: 24-34, October Pt.2:34-39

Rios, J.A., 1999, Laboratory Fume Hoods and Air-Flow Control Systems, *Heating Piping and Air Conditioning Engineering*, December: 35-39

United States.,2000 Environmental Protection Agency. Laboratories for the 21st Century: an Introduction to Low-Energy Design. August. May 15  
<http://www.epa.gov/labs21century/>

Vangeet, O., Reilly, S., 2006, Ventilation Heat Recovery for Laboratories, *ASHRAE Journal*, May: 44-53