

2001

Predicting Soil Nitrate-Nitrogen Losses from Incorporated Poultry Manure Using the GLEAMS Model

Adion J. Chinkuyu
Iowa State University

Rameshwar S. Kanwar
Iowa State University, rskanwar@iastate.edu

Follow this and additional works at: http://lib.dr.iastate.edu/abe_eng_pubs

 Part of the [Agriculture Commons](#), [Bioresource and Agricultural Engineering Commons](#), and the [Soil Science Commons](#)

The complete bibliographic information for this item can be found at http://lib.dr.iastate.edu/abe_eng_pubs/669. For information on how to cite this item, please visit <http://lib.dr.iastate.edu/howtocite.html>.

This Article is brought to you for free and open access by the Agricultural and Biosystems Engineering at Iowa State University Digital Repository. It has been accepted for inclusion in Agricultural and Biosystems Engineering Publications by an authorized administrator of Iowa State University Digital Repository. For more information, please contact digirep@iastate.edu.

Predicting Soil Nitrate-Nitrogen Losses from Incorporated Poultry Manure Using the GLEAMS Model

Abstract

Proper calibration and validation of computer models can inexpensively and quickly assess the impacts of different agricultural management practices on water quality. This study used Groundwater Loading Effects of Agricultural Management Systems (GLEAMS) version 2.1 to determine the effects of two nitrogen (N) application rates (168 kg N/ha (168PM) and 336 kg N/ha (336PM)) from poultry manure and one N application rate (168 kg N/ha (168UAN)) from urea ammonium nitrate (UAN) fertilizer on NO₃-N loss with subsurface drainage. The simulated NO₃-N losses by the GLEAMS model were compared with two-year (1999 and 2000) monthly measured NO₃-N losses from six 2.1-m² field lysimeters under continuous corn production.

Results indicated that the two-year average simulated subsurface drainage consistently followed the average measured subsurface drainage from 168UAN, 168PM, and 336PM treatments, with mean errors of 9%, 3%, and -2%, respectively. The model was capable of predicting overall NO₃-N concentration in subsurface drainage from lysimeters under 168UAN, 168PM, and 336PM treatments reasonably well, giving mean errors of 19%, -29%, and 9%, respectively. The overall two-year results also show that there were no significant differences ($p=0.05$) between average measured and simulated NO₃-N losses with subsurface drainage from poultry manure treatments. The study concluded that the GLEAMS model can be used as a viable management and decision-making tool to assess the impacts of long-term poultry manure application on water quality and agricultural production for Iowa soils.

Keywords

Lysimeters, Poultry manure, NO₃-N, Drainage, GLEAMS, Nitrate, Nitrogen, Nonpoint source

Disciplines

Agriculture | Bioresource and Agricultural Engineering | Soil Science

Comments

This article was published in Transactions of the ASAE. Vol. 44(6): 1643-1650, doi:[10.13031/2013.7051](https://doi.org/10.13031/2013.7051).
Posted with permission.

PREDICTING SOIL NITRATE–NITROGEN LOSSES FROM INCORPORATED POULTRY MANURE USING THE GLEAMS MODEL

A. J. Chinkuyu, R. S. Kanwar

ABSTRACT. Proper calibration and validation of computer models can inexpensively and quickly assess the impacts of different agricultural management practices on water quality. This study used Groundwater Loading Effects of Agricultural Management Systems (GLEAMS) version 2.1 to determine the effects of two nitrogen (N) application rates (168 kg N/ha (168PM) and 336 kg N/ha (336PM)) from poultry manure and one N application rate (168 kg N/ha (168UAN)) from urea ammonium nitrate (UAN) fertilizer on NO_3^- -N loss with subsurface drainage. The simulated NO_3^- -N losses by the GLEAMS model were compared with two-year (1999 and 2000) monthly measured NO_3^- -N losses from six 2.1-m² field lysimeters under continuous corn production.

Results indicated that the two-year average simulated subsurface drainage consistently followed the average measured subsurface drainage from 168UAN, 168PM, and 336PM treatments, with mean errors of 9%, 3%, and -2%, respectively. The model was capable of predicting overall NO_3^- -N concentration in subsurface drainage from lysimeters under 168UAN, 168PM, and 336PM treatments reasonably well, giving mean errors of 19%, -29%, and 9%, respectively. The overall two-year results also show that there were no significant differences ($p=0.05$) between average measured and simulated NO_3^- -N losses with subsurface drainage from poultry manure treatments. The study concluded that the GLEAMS model can be used as a viable management and decision-making tool to assess the impacts of long-term poultry manure application on water quality and agricultural production for Iowa soils.

Keywords. Lysimeters, Poultry manure, NO_3^- -N, Drainage, GLEAMS, Nitrate, Nitrogen, Nonpoint source.

The poultry industry is one of the largest and fastest-growing sectors in the world, with meat and egg production currently growing at an annual rate of approximately 5% (Sims and Wolf, 1994). In January of 2001, Iowa ranked number one in the nation in layer production (Iowa Agricultural Statistics, 2001). The poultry industry in Iowa produces large volumes of manure that need to be utilized on crop and pasturelands, usually near the poultry production sites. Rapid and concentrated growth of the poultry industry has increased the concern about environmental pollution due to excessive application of poultry manure. From a nonpoint source pollution standpoint, water quality parameters of greatest concern are nitrate–nitrogen (NO_3^- -N), phosphate–phosphorus (PO_4^- -P), and pathogenic bacteria. Each of these constituents of poultry manure has the potential to pollute surface and groundwater resources if

poultry manure is not managed properly within a watershed. The forms and quantities of phosphorus (P) and nitrogen (N) in the soil change with poultry manure application and management practices.

The complexity of factors and processes affecting nonpoint source pollution makes experimental assessment of environmental consequences of different agricultural management strategies laborious and expensive. Therefore, one possible method is to use the existing databases to modify and validate selected computer models, then use the models to simulate the long-term impacts of alternative management systems (Shirmohammadi et al., 1998). The use of computer models also provides an opportunity to evaluate the response of soil and water resources to several different farming practices in an efficient and cost-effective way. Mathematical models are useful tools in assessing the impacts of alternative agricultural management practices on water quality. The importance of using simulation models to analyze agricultural management practices affecting soil and water resources has been documented by many researchers (Knisel, 1993; Bakhsh et al., 2000; Shirmohammadi, 1990). Some field-scale models that are used for evaluating the impacts of agricultural management practices on water quality include Groundwater Loading Effects of Agricultural Management Systems (GLEAMS) (Leonard et al., 1987); Chemicals, Runoff and Erosion from Agricultural Management Systems (CREAMS) (Knisel, 1980); Pesticide version of Leaching Estimation And Chemistry Model (LEACHMP) (Wagenet and Hutson, 1986); and Pesticide Root Zone Model (PRZM) (Carsel et al., 1984). Except for CREAMS and GLEAMS,

Article was submitted for review in March 2001; approved for publication by the Soil & Water Division of ASAE in October 2001.

Journal Paper No. J 19078 of the Iowa Agriculture and Home Economics Experiment Station, Iowa State University, Ames, Iowa 50011. Project No. 3415. This research was supported by the Leopold Center for Sustainable Agriculture and the Iowa Egg Council.

The authors are **Adion J. Chinkuyu**, ASAE Member, Post-Doctoral Research Associate, and **Rameshwar S. Kanwar**, ASAE Member Engineer, Professor and Director, Iowa State Water Resources Research Institute, Department of Agricultural and Biosystems Engineering, Iowa State University, Ames, Iowa. **Corresponding author:** Adion J. Chinkuyu, Environmental Sciences Dept., University of California–Riverside, 2217 Geology Bldg, Riverside, CA 92521; phone: 909-787-6395; fax: 909-787-3993; e-mail: acinkuyu@mail.ucr.edu.

some of these models simulate pesticides only or ignore important processes, such as N and P transformation processes of animal manure applied to the land; therefore, these models were not considered for this study. The GLEAMS model is a modification of a CREAMS model to simulate edge-of-field and bottom-of-root-zone loadings of water, sediment, pesticides, and plant nutrients from the complex climate-soil-management interactions (Knisel, 1993). As a field-scale water quality model that has sediment/erosion yield, hydrology, and chemical submodels, GLEAMS has been validated under different conditions and management practices with varied results (Yoon et al., 1994; Shirmohammadi et al., 1998; Stone et al., 1998; Bakhsh et al., 2000).

Shirmohammadi et al. (1998) reported that the GLEAMS model was capable of producing reasonable estimates of annual and long-term averages of NO_3^- -N and dissolved P losses to subsurface drains under structured soils on the Vara Plains of southwest Sweden. Stone et al. (1998) reported that the difference between GLEAMS model simulated-groundwater NO_3^- -N concentrations and observed values were ± 1.3 mg/L and ± 19 mg/L, respectively, for a corn/wheat/soybean rotation field and a Bermuda grass field sprayed with swine manure. Minkara et al. (1995) used the GLEAMS model to predict NO_3^- -N and NH_4^+ -N losses with surface runoff and subsurface drainage from poultry manure applications. The authors found large differences between observed and predicted data for all manure application rates. Yoon et al. (1994) found that GLEAMS simulation of soluble and sediment P losses in surface runoff and NO_3^- -N concentrations in leachate and soil layers were not consistent with field data from poultry manure treatments under corn at Belle Mina, AL. Bakhsh et al. (2000) found that the GLEAMS model predicted NO_3^- -N losses with subsurface drainage were relatively consistent with the measured NO_3^- -N losses with drainage water from plots treated with swine manure at Nashua, Iowa. The GLEAMS model has been validated for swine manure or poultry manure under different soil types and climatic conditions other than those in central Iowa. Thus, no computer modeling studies have been conducted in Iowa on the use of poultry manure applied to continuous cornfields.

The main objective of this study was to calibrate the GLEAMS model using field measured data from suction lysimeters to predict NO_3^- -N losses in subsurface drainage under poultry manure and liquid urea ammonium nitrate (UAN) fertilizer applications for continuous corn production. Another objective was to evaluate the performance of the GLEAMS model by making comparisons between the measured and simulated subsurface drainage volumes and NO_3^- -N concentration in subsurface drainage water using two years (1999 and 2000) of data collected at the Iowa State University research farm near Ames, Iowa.

BACKGROUND REVIEW OF GLEAMS

The GLEAMS model is a computer program used to simulate physical processes affecting water quality in an agricultural field. Detailed descriptions of the model have been given elsewhere (Leonard et al., 1987; Knisel et al., 1989; Knisel, 1993). The GLEAMS model has three submodels: sediment/erosion yield, hydrology, and chemical transport. The chemical transport submodel is further subdivided into pesticide and nutrient components. Because the pesticide subcomponent of GLEAMS was not used in this study, the

reader is referred to other publications for this information (Leonard et al., 1987; Knisel, 1993; Shirmohammadi and Knisel, 1994). The nutrient subcomponent incorporates major N processes such as nitrification, mineralization, ammonification, immobilization, volatilization, denitrification, plant uptake, fixation by legumes, and N losses through runoff, erosion, and percolation below the root zone. The model considers surface and subsurface pathways to estimate edge-of-field and bottom-of-root-zone loadings to assess management alternatives. The GLEAMS model also includes agricultural management practices such as tillage, irrigation, and land application of animal manure, as well as application of commercial fertilizers.

The model simulates land application of animal manure by creating appropriate N and P pools for mineralization, because organic N and P mineralize at a higher rate than active soil mineralizable N and P (Yoon et al., 1994). The model considers ammonia volatilization from surface-applied animal manure using a relationship developed by Reddy et al. (1979). In GLEAMS, mineralization of N is considered a two-stage process consisting of first-order ammonification and zero-order nitrification processes (Knisel, 1993). Nitrification is represented as a zero-order process because it is not a function of the amount of ammonia in the soil layer. Ammonification occurs from the active soil N, fresh organic N from root and surface residue, and organic N in animal manure. Soil water and soil temperature factors are used to adjust mineralization and nitrification rates. Nitrification occurs when the soil water content is above immobile water content and below saturation with an optimum at field capacity. Denitrification is considered a first-order process as a linear function of organic carbon and modified by soil-water content and temperature. The model uses an N immobilization process similar to one developed by Seligman and van Keulen (1981) except that GLEAMS considers two sources of N: ammonia and nitrate. In estimating N demand in a field, the model uses the N uptake process used in the Environmental Policy Integrated Climate (EPIC) model (Sharpley and Williams, 1990). The model also uses partitioning coefficients to distribute N and P between the solution and solid phases in the surface soil.

FIELD EXPERIMENTS AND INPUT DATA

Data for model calibration and validation were obtained from field lysimeter experiments conducted between 1998 and 2000 at the Iowa State University's Agronomy and Agricultural Engineering Research Center (AAERC) near Ames, Iowa. The lysimeters were installed on Nicollet loam soil formed in glacial till under the prairie vegetation with an organic matter content of about 3% and a maximum slope of 3% (Kanwar et al., 1988). Nicollet soils are characterized as moderately permeable and somewhat poorly drained. In this study, six 2.1-m² field lysimeters (2.28 m long \times 1.50 m deep \times 0.91 m wide; fig. 1) were used. The lysimeters were constructed in 1992 and were arranged in two rows, spaced at 3.81 m between rows and between lysimeter boxes within rows (fig. 2). A detailed description of the lysimeter construction and installation is given by Blanchet (1996).

EXPERIMENTAL TREATMENTS

During the three growing seasons (1998 to 2000), N application to the lysimeters included application rates of 168

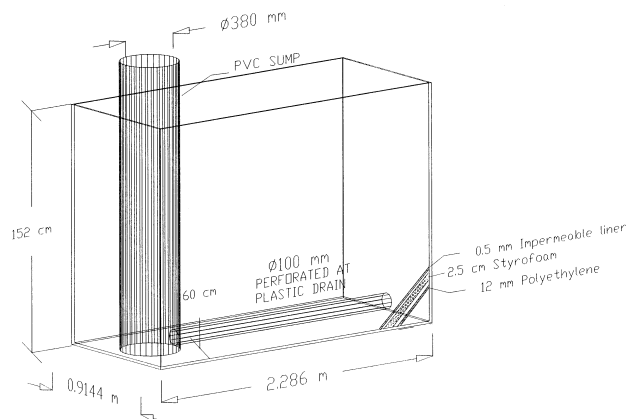

Figure 1. Design details of lysimeter construction box to study the effects of N management systems on subsurface drainage water quality.

kg N/ha from liquid urea ammonium nitrate (UAN) fertilizer (168UAN), 168 kg N/ha (168PM) and 336 kg N/ha (336PM) from laying hen/poultry manure. Table 1 gives the characteristics of the poultry manure used for this study during 1998 to 2000. Immediately after the application of manure and UAN fertilizer, the soil was tilled with a shovel and rake to incorporate the manure and fertilizer in the top 0–15 cm of the surface soil to minimize N loss through volatilization. The three N application rate treatments were randomly assigned to lysimeters with two replications of each treatment. Corn (Dekalb 580) was planted in all lysimeters during the three growing seasons (1998 to 2000). Planting was done immediately after applying manure and fertilizer at a spacing of 0.75 m between rows and 0.2 m within the row. Weeding and cultivation were done when necessary in all lysimeters. No irrigation, herbicides, or pesticides were applied to lysimeters.

ANALYSIS OF NO_3^- -N IN SUBSURFACE DRAINAGE SAMPLES

Water samples were collected from lysimeter sumps once a week or a day after rainfall. Lysimeter sumps were pumped empty and samples were collected near the end of the pumping cycle to minimize contamination across samples. The amount of subsurface drainage was determined by weighing the water on a balance. The water samples were collected in plastic bottles and were stored at a temperature of 4°C immediately after collection. Water samples were later (every four weeks) analyzed for NO_3^- -N concentration in the National

Soil Tilth Laboratory in Ames, Iowa. NO_3^- -N concentrations in drainage water were analyzed using an automated Technicon Autoanalyzer II. Monthly NO_3^- -N losses from lysimeter sumps were calculated by summing the product of weekly total flow and the NO_3^- -N concentration of the sample taken that week. The monthly value was divided by the area of the lysimeter to get nutrient loss per unit area. Weekly flow-weighted average concentrations were calculated by summing the weekly NO_3^- -N loss and dividing the sum by the total flow for the week.

GLEAMS MODEL INPUT

The GLEAMS model was run continuously for the period 1 January 1998 through 31 December 2000 in order to minimize the effects of parameter estimation at the beginning of each year. Weather data from a weather station at the experimental site, soil data, and management data from the site were used for the simulation. Where local data were not available, default values from the user's manual were used (Knisel, 1993).

Hydrological Data. The GLEAMS model requires mean daily air temperature and daily precipitation data as input. The model uses mean daily temperature to determine whether precipitation is rain or snow. The hydrology subroutine requires mean monthly maximum and minimum temperatures, solar radiation, wind speed, and dew point temperature data. These data were measured at the experimental site and were used as input to the model.

Soil Data. Data on clay, silt, sand fractions, porosity, field capacity, wilting point, organic matter, and hydraulic conductivity were obtained from Blanchet (1996) and Kanwar et al. (1988). These properties were measured at the time of lysimeter installation. Small soil columns (15 cm long \times 7.5 cm diameter) were used to determine saturated hydraulic conductivity. Based on the soil properties at the site, the soils in the lysimeters were classified as belonging to the hydrological soil Group B according to the GLEAMS user's manual. The root zone was divided into five horizons based on soil texture. Selected physical properties of each soil horizon are presented in table 2.

Management Practices. Hand tillage of soil in the lysimeters by a shovel and a rake was considered to be equivalent to chisel plow. Tillage was done in spring before the application of poultry manure and commercial fertilizer. Poultry manure and commercial fertilizer were incorporated (0.15 m deep) immediately after application to minimize ammonia

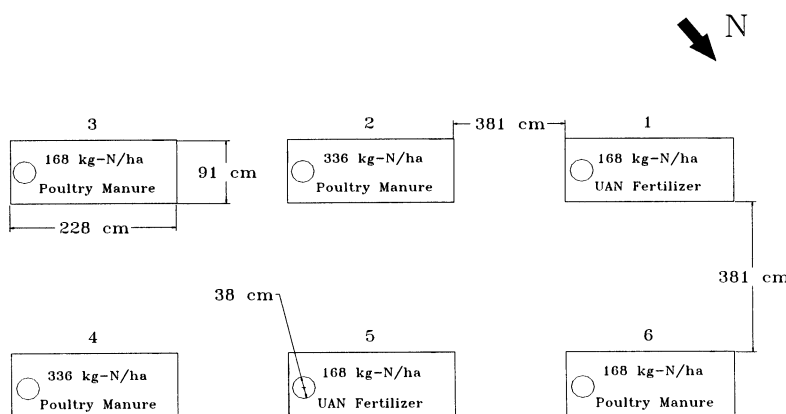

Figure 2. Layout of lysimeters to study the effects of N management systems on subsurface drainage water quality.

Table 1. Characteristics of poultry manure applied to lysimeters and used as input to the GLEAMS model.

Characteristics ^[a]	Nitrogen treatments for three years					
	168 kg N/ha poultry manure			336 kg N/ha poultry manure		
	1998	1999	2000	1998	1999	2000
Average manure application rate (kg/ha)	15714	7952	6000	31714	15905	12000
Average N application rate (kg N/ha)	167 ^[b]	169	162	337	338	325
Total Kjeldhal nitrogen (TKN) (%N)	1.5	3.0	3.8	1.5	3.0	3.8
Ammonia (NH ₃) (%N)	1.1	0.8	0.7	1.1	0.8	0.7
Organic N (%)	0.4	2.2	3.1	0.4	2.2	3.1
Total phosphorus (%P)	1.0	4.2	3.7	1.0	4.2	3.7
Potassium (%K)	1.4	1.9	2.4	1.4	1.9	2.4
Moisture content (%)	48	55	28	48	55	28

^[a] Data expressed on wet weight basis.

^[b] Assumed 5% N lost during application and 75% N available during the first year; no N credits were considered for subsequent years.

volatilization. Field cultivation, as a secondary tillage operation, was done in late spring by a hoe. Dates of all management activities for the three seasons are presented in table 3.

Plant Growth Variables and Parameters. Corn was grown during the three seasons. Crop characteristics data required by the model, such as leaf area index, crop height, dry matter ratio, residue C: N ratio, and N: P ratio, were taken from the model database (Knisel, 1993).

Initial Conditions. Calibration of the model was done by adjusting the curve number, soil evapotranspiration, and effective rooting depth until best possible drainage volume and NO₃⁻-N concentration results were obtained. These calibration parameters were chosen because of their sensitivity in affecting percolation, surface runoff, and evaporation. In the nutrient input file, crop residue was estimated to be 550 kg/ha (Knisel, 1993); total N content, potentially mineralizable N, total P, and P concentration data for each soil horizon were not available, so default values were used. Measured field

soil NO₃⁻-N concentrations at the beginning of the 1998 growing season were used as initial NO₃⁻-N concentrations at the beginning of the simulation.

MODEL CALIBRATION AND EVALUATION

Errors can be introduced during simulation due to factors such as poor representation of measured soil properties, or a set of equations that represent the soil, water flow, and N transformation processes that may not adequately represent field conditions (Bakhsh et al., 2000). Therefore, calibration of key parameters of the model such as the evapo- transpiration, Natural Resources Conservation Service (NRCS) curve number for soil moisture condition II (CN2), and effective rooting depth (RD) are essential. Soil evapotranspiration factor of 3.0 (based on soil properties), RD of 110 cm, and CN2 of 80 for hydrologic soil Group B were selected from the user's manual and calibrated for all lysimeters for the beginning of the 1998 season (table 4). The final calibrated parameter values were 3.3, 120 cm, and 77, for soil evapotranspiration factor, RD, and CN2, respectively (table 4). The soil evapotranspiration factor, RD, and CN2 calibrations were made to fit the simulated water percolation below the root zone to the 1998-measured subsurface drainage volume from all lysimeters (averaged by treatment). Initial soil NO₃⁻-N concentrations were also adjusted (during calibration) in order to simulate the best possible monthly NO₃⁻-N concentrations and losses (mean difference of less than 20%) at the beginning of the 1998 season. A trial and error procedure was used to determine the best set of input values to minimize the difference between measured and simulated drainage volume and NO₃⁻-N concentrations (table 5).

The calibrated model was tested using measured data for 168UAN treatments (lysimeters 1 and 5), 168PM treatments (lysimeters 3 and 6), and 336PM treatments (lysimeters 2 and 4) over a two-year period (1999–2000). Thus, model calibration was done using 1998 data and model validation was done using 1999 and 2000 data. Model evaluation criteria were based on objective and subjective approaches (Singh and Kanwar, 1995; Bakhsh et al., 2000). Subjective criteria

Table 2. Selected physical soil properties used as inputs to GLEAMS hydrology file (from Blanchet, 1996; Kanwar et al., 1988).

Soil depth (cm)	Clay (%)	Silt (%)	Sand (%)	Organic matter (%)	Porosity (%)	Field capacity (%)	Wilting point (%)	Sat. hydraulic conductivity (cm/hr)
168UAN ^[a]								
0–15	23	35	42	4.0	44	32	26	3.5
15–30	28	38	34	4.0	50	32	26	3.5
30–45	28	38	34	3.2	51	29	24	3.3
45–91	26	36	38	2.6	49	28	24	2.5
91–120	22	25	53	0.5	47	26	24	2.1
168PM ^[a]								
0–15	23	35	42	4.0	44	33	24	3.5
15–30	28	38	34	4.0	49	33	22	3.5
30–45	28	38	34	3.2	51	32	22	3.0
45–91	26	36	38	2.6	49	28	22	2.5
91–120	22	25	53	0.5	46	27	22	2.0
336PM ^[a]								
0–15	23	35	42	4.0	44	33	25	3.5
15–30	28	38	34	4.0	49	33	25	3.5
30–45	28	38	34	3.2	51	30	24	3.0
45–91	26	36	38	2.6	49	28	24	2.5
91–120	22	25	53	0.5	46	26	22	2.0

^[a] 168UAN = 168 kg N/ha urea ammonium nitrate, 168PM = 168 kg N/ha poultry manure, 336PM = 336 kg N/ha poultry manure.

Table 3. Dates of field activities in lysimeters for 1998 to 2000.

Activity	Year and date of activity		
	1998	1999	2000
Primary tillage	20 May	5 May	14 April
Applying fertilizer and poultry manure	20 May	5 May	14 April
Incorporating fertilizer and poultry manure	20 May	5 May	14 April
Planting corn (variety DK 580)	21 May	10 May	8 May
Cultivating in lysimeters	20 June	29 June	13 June
Harvesting corn	5 Oct.	12 Oct.	21 Sept.

Table 4. Sensitive parameters used in calibration of GLEAMS model.

GLEAMS model parameter ^[a]	N treatments					
	168UAN		168PM		336PM	
	First ^[b]	Final ^[c]	First	Final	First	Final
	Initial conditions					
Soil evapotranspiration	3.0	3.3	3.0	3.3	3.0	3.3
NRCS curve number	80	77	80	77	80	77
Effective root depth (cm)	110	120	110	120	110	120
Soil NO ₃ -N concentration (mg/L) at depth:						
15 cm	8.3	7.8	15.7	5.1	12.3	10.8
30 cm	8.3	6.6	15.7	5.0	12.3	10.8
45 cm	4.3	4.5	5.5	2.5	8.3	8.5
91 cm	4.7	4.2	3.5	1.3	6.1	4.7
120 cm	2.1	3.0	3.3	1.1	6.1	4.7

^[a] No other parameters were calibrated in the model.

^[b] "First" means first initial conditions before calibration.

^[c] "Final" means final initial conditions after calibration. Final values were used to simulate 1999 and 2000.

Table 5. Calibrated annual average measured and simulated subsurface drainage volume, NO₃-N concentration, and NO₃-N loss with subsurface drainage for the 1998 season.

N treatment	Subsurface drainage volume (mm)		NO ₃ -N concentration (mg/L)		NO ₃ -N loss (kg/ha)	
	Meas ^[a]	Pred ^[b]	Meas	Pred	Meas	Pred
	168UAN	280	266	15.2	16.3	42.6
168PM	206	219	10.9	10.4	22.4	22.8
336PM	246	231	21.3	19.7	52.3	45.4

^[a] "Meas" means measured value.

^[b] "Pred" means predicted value.

Table 6. Average measured and predicted corn yields at 15.5% moisture content (kg/ha).

Nitrogen treatment	Year	Number of observations	Yield (kg/ha)		% Error
			Measured	Predicted	
168 kg N/ha UAN	1999	2	7450	5861	-27
168 kg N/ha UAN	2000	2	5989	4787	-25
Average:		4	6720	5324	-26
168 kg N/ha PM	1999	2	8603	7856	-10
168 kg N/ha PM	2000	2	7003	8232	15
Average:		4	7803	8044	3
336 kg N/ha PM	1999	2	10003	9240	-8
336 kg N/ha PM	2000	2	9967	9016	-11
Average:		4	9985	9128	-9

included graphical display of simulated and measured drainage volume and NO₃-N concentration and loss. The subjective criteria were used to locate anomalies in model

predictions and to provide an insight on temporal response of the model for the entire simulation period. Objective criteria included statistical analysis (paired t-test, correlation coefficient, percent difference) between measured and simulated values. Objective criteria account for differences in mass of the simulation, ignoring its distribution over time. The overall model evaluation was based on the predictions of two years, from 1999 to 2000.

RESULTS AND DISCUSSION

Daily and weekly simulations (data not shown) showed that there were short travel times and distances for each soil layer, which resulted in sharp percolation and NO₃-N concentration peaks for each major rainfall event when compared with daily or weekly measured data. The lack of routing percolation water to drainage might have resulted in sharp peaks of the daily subsurface drainage simulations. Based on these differences, monthly simulations were deemed more reasonable than daily or weekly simulations when comparing simulated percolation with measured subsurface drainage. The results presented in this paper are corn yields, monthly subsurface drainage volume, and NO₃-N concentration and NO₃-N loss with subsurface drainage. Subsurface drainage volumes measured at 1.2 m depth were considered analogous to simulated percolation at 1.2 m depth (Shirmohammadi et al., 1998).

SIMULATION OF CORN YIELDS

The results in table 6 show that the GLEAMS model predicted corn yields from 168PM and 336PM treatments and under-predicted corn yields for the 168UAN treatment, with percent errors of 3%, -10%, and -26%, respectively. One possible reason for under-predicting corn yields for 168UAN treatment could be lack of the model to allocate N from inorganic fertilizer for crop uptake (14 g), in comparison with 40 g and 54 g for 168PM and 336PM treatments, respectively. In GLEAMS, N uptake is based on the assumption that nitrate and ammonia uptake is equal to the relative mass of each species in the soil layer from which transpiration occurs (Knisel, 1993). If both nitrate and ammonia availability are limited, and N uptake is less than demand, an N stress factor is calculated to reduce the crop leaf area index, which in turn reduces crop yield.

SIMULATION OF SUBSURFACE DRAINAGE VOLUME

Figure 3 shows average monthly model simulation of subsurface drainage volume against a 1:1 best-fit line for the 168UAN, 168PM, and 336PM treatments. The predicted percolation followed the pattern of measured subsurface drainage giving coefficients of determinations of greater than 0.94 for all treatments (table 7). On an annual basis, the model performed well in simulating subsurface drainage for all treatments with relative percent errors of less than ±10%, except in 2000 when the model over-predicted percolation by 17% for the 168UAN treatment. In GLEAMS, soil moisture storage capacity is equivalent to field capacity such that any excess water above field capacity is released to the lower soil layer thereby producing high percolation. The overall results for continuous simulation show that there were no significant differences (p = 0.05) between the measured and simulated drainage volume for the 168UAN, 168PM, 336PM treatments, with relative percentage errors of 9%, 3%, and -2%,

respectively (table 7). The monthly cumulative measured and simulated drainage volumes were plotted in figure 4 to subjectively examine the differences between measured and simulated percolations over the two-year period (1999 and 2000).

Table 7. Summary of statistical comparison of average measured and predicted subsurface drainage volume from lysimeters under different N treatments.

Year	Measured volume (mm)	Predicted volume (mm)	Number of observations	P>t ^[a]	R ²	% error
168UAN						
1999	342	346	10	0.87	0.95	1
2000	72	87	6	0.57	0.78	17
2-yr. avg	207	217	16	0.54	0.94	9
168PM						
1999	285	314	10	0.32	0.98	9
2000	78	75	6	0.92	0.74	-4
2-yr. avg	181	194	16	0.56	0.94	3
336PM						
1999	350	328	10	0.15	0.99	-7
2000	93	96	6	0.92	0.99	3
2-yr. avg	222	212	16	0.22	0.99	-2

^[a] If $p > t$ is less than 0.05, then the means are significantly different.

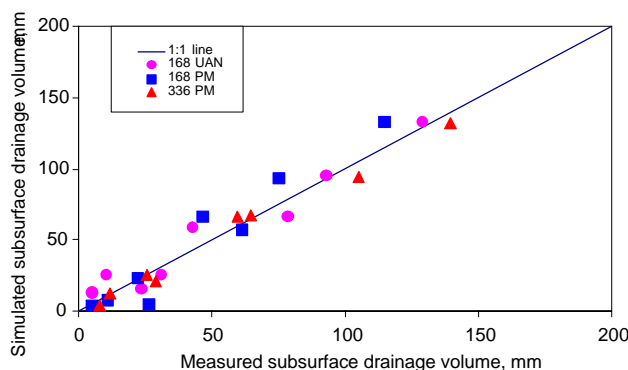

Figure 3. Average monthly measured and simulated subsurface drainage volume from lysimeters under different N treatments (168UAN = 168 kg N/ha urea ammonium nitrate, 168PM = 168 kg N/ha poultry manure, and 336PM = 336 kg N/ha poultry manure).

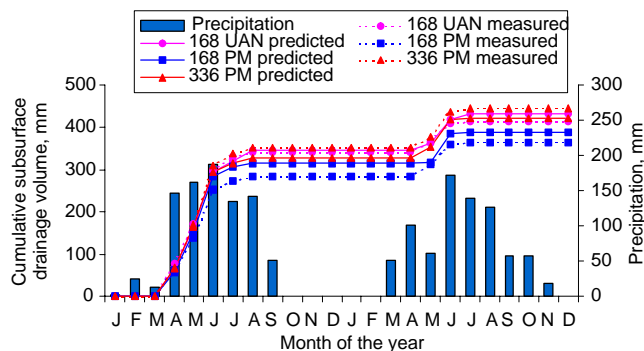

Figure 4. Average monthly precipitation and measured and simulated cumulative subsurface drainage volume from lysimeters under different N treatments.

SIMULATION OF NO₃-N CONCENTRATION IN SUBSURFACE DRAINAGE

The results in table 8 show that in 2000, the model over-predicted NO₃-N concentration in subsurface drainage for the 168UAN treatment, showing a relative percentage error of 29%. Also, in the year 2000 the model significantly under-predicted NO₃-N concentration in subsurface drainage for the 168PM treatment, giving a percentage difference of -62%. The differences in the year 2000 could be due to the fact that the year was relatively dry and the model failed to properly predict NO₃-N concentration in percolation water. In the model, the nitrification process occurs when the soil water content is above immobile water content and below saturation with an optimum at field capacity. During 1999, the model performed well in predicting NO₃-N concentration in subsurface drain water from all treatments (table 8 and figs. 5 and 6).

The model over-predicted NO₃-N concentrations during the early part of each season, except in 1999 for the 336PM treatments (fig. 6). This was probably due to the fact that the ammonium in the manure needed time to mineralize and mix with the soil before being leached out as NO₃-N, a process not simulated properly by the GLEAMS model. Also, errors in the initial conditions (calibration) may have contributed to over-prediction of NO₃-N concentration at the beginning of the simulation. Lack of routing the percolation water to drainage might have contributed to high predicted values of NO₃-N concentrations at the beginning of the season (Bakhsh et al., 2000). Although there were some variations between monthly predicted and measured NO₃-N concentrations, overall two-year results show that the model performed well in simulating NO₃-N concentrations in subsurface drainage from the 168UAN, 168PM, and 336PM treatments, which gave relative percentage differences of 19%, -29%, and 9%, respectively.

SIMULATION OF NO₃-N LOSS WITH SUBSURFACE DRAINAGE

Figure 7 shows the 1:1 best-fit line between average (two replicates) monthly measured and predicted NO₃-N losses during the two years (1999 and 2000) for all treatments. The data presented in table 9 show that in 2000, the GLEAMS model over-predicted annual NO₃-N losses with subsurface

Table 8. Statistical comparison of average measured and predicted NO₃-N concentration in subsurface drainage water from lysimeters under different N treatments.

Year	Measured conc. (mg/L)	Predicted conc. (mg/L)	Number of observations	P>t ^[a]	R ²	% error
168UAN						
1999	8.7	9.5	10	0.76	0.16	8
2000	6.3	8.9	6	0.06	0.94	29
2-yr. avg	7.5	9.2	16	0.37	0.01	19
168PM						
1999	9.7	10.2	10	0.82	0.09	5
2000	4.2	2.6	6	0.04 ^[b]	0.06	-62
2-yr. avg	6.8	6.9	16	0.48	0.01	-29
336PM						
1999	16.1	16.4	10	0.60	0.97	2
2000	10.4	12.4	6	0.58	0.98	16
2-yr. avg	13.3	14.4	16	0.41	0.70	9

^[a] If $p > t$ is less than 0.05, then the means are significantly different.

^[b] Average measured values were significantly different from average predicted values at significance level of $p = 0.05$.

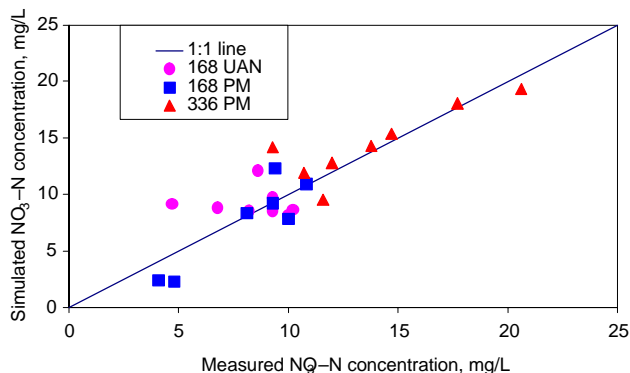

Figure 5. Average monthly measured and simulated NO_3^- -N concentrations in subsurface drainage from lysimeters under different N treatments.

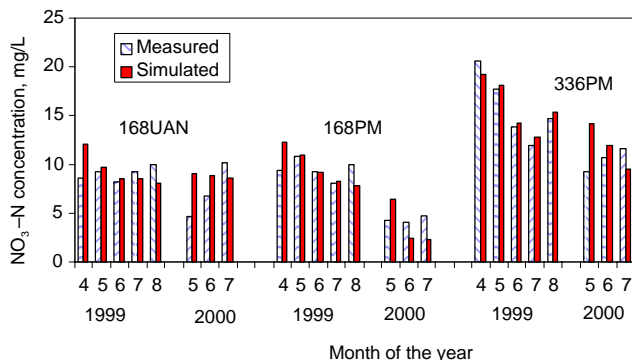

Figure 6. Comparison of flow-weighted monthly measured and simulated NO_3^- -N concentrations in subsurface drainage from lysimeters under different N treatments.

Table 9. Statistical comparison of average measured and predicted NO_3^- -N loss in subsurface drainage water from lysimeters under different N treatments.

Year	Measured mass (kg/ha)	Predicted mass (kg/ha)	Number of observations	$P > t ^{[a]}$	R^2	% error
168UAN						
1999	29.9	32.8	10	0.18	0.97	9
2000	4.5	7.7	6	0.23	0.97	42
2-yr. avg	17.2	20.2	16	0.04 ^[b]	0.95	25
168PM						
1999	27.5	31.9	10	0.14	0.99	14
2000	3.3	2.7	6	0.16	0.99	-22
2-yr. avg	15.4	17.3	16	0.42	0.99	-4
336PM						
1999	56.4	53.6	10	0.12	0.99	-5
2000	9.7	11.8	6	0.36	0.97	18
2-yr. avg	33.1	32.7	16	0.84	0.98	7

^[a] If $p > t$ is less than 0.05, then the means are significantly different.

^[b] Average measured values were significantly different from average predicted values at significance level of $p = 0.05$.

drainage for the 168UAN treatment, giving relative percentage error of 42%. In the same year, however, the model under-predicted annual NO_3^- -N loss for the 168PM treatment drainage for the 168UAN treatment, giving relative percentage error of 42%. In the same year, however, the model under-predicted annual NO_3^- -N loss for the 168PM treatment by a percentage error of -22%, which was due to the fact that the model under-predicted NO_3^- -N concentrations in sub

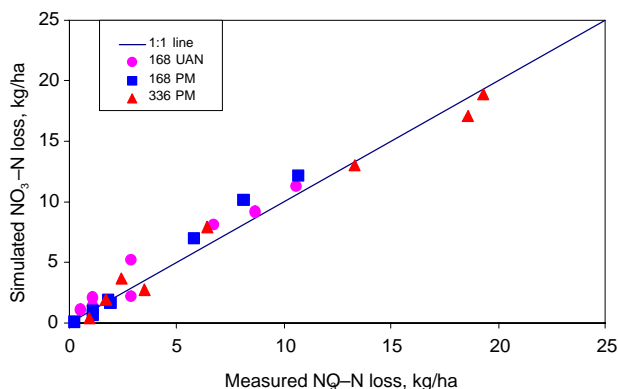

Figure 7. Average monthly measured and simulated NO_3^- -N loss with subsurface drainage from lysimeters under different N treatments.

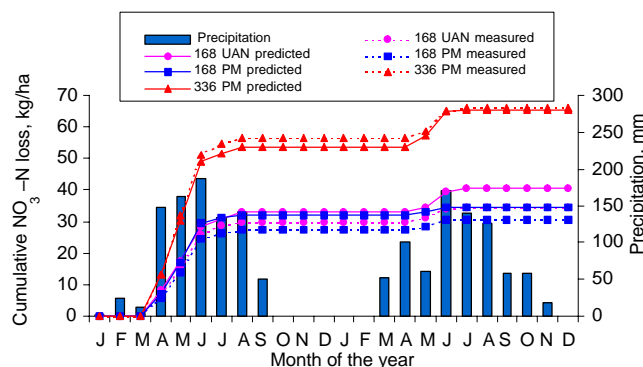

Figure 8. Average monthly precipitation, and measured and simulated cumulative NO_3^- -N loss with subsurface drainage from lysimeters under different N treatments.

Table 10. Average N balance from lysimeters under different N treatments.

	N treatments								
	168UAN			168PM			336PM		
	1999	2000	Avg	1999	2000	Avg	1999	2000	Avg
N mass (g)									
Additions									
Manure/fertilizer	35	35	35	36	34	35	71	68	70
Losses									
Plant uptake	13	14	14	39	41	40	55	53	54
Leaching	7	2	5	7	1	4	11	3	7
Denitrification	23	15	19	25	21	23	70	59	65
Volatilization	0	0	0	1	1	1	1	1	1
Runoff ^[a]	-	-	-	-	-	-	-	-	-
Total loss	43	31	37	72	63	68	137	116	127
Net balance	-8	4	-2	-36	-29	-33	-66	-48	-57

^[a] N losses through runoff were not computed because there was no runoff event measured or predicted.

surface drainage. Overall results (two-year) show that the model performed reasonably well in continuously simulating NO_3^- -N losses for the 168PM and 336PM treatments, with relative percentage errors of -4% and 7%, respectively. The model over-predicted NO_3^- -N loss for the 168UAN treatment, giving a relative percentage error of 25%. Graphical comparisons between average monthly cumulative predicted and measured NO_3^- -N losses are shown in figure 8. Data presented in table 10 show that the 168PM and 336PM treat-

ments had higher simulated overall N losses when compared with the 168UAN treatment, with mean losses of 68, 127, and 37 g, respectively. High N losses from poultry manure treatments were attributed to denitrification and high N uptake by plants. The high N uptake from poultry manure treatments is reflected in the corn yields. The results show that all treatments had negative nitrogen balances indicating that the model predicted higher N losses than what was applied. No losses with runoff were computed because there were no runoff events.

SUMMARY AND CONCLUSIONS

The GLEAMS v.2.1 model was used to predict the effects of two N application rates (168 kg N/ha and 336 kg N/ha) from poultry manure and 168 kg N/ha from UAN fertilizer on subsurface drainage volume, NO_3^- -N concentration, and NO_3^- -N loss. Poultry manure and commercial N fertilizer were applied to 2.1-m² field lysimeters each spring before planting corn. The treatments were replicated twice. The GLEAMS model was calibrated with curve number, soil evapotranspiration parameter, and effective rooting depth to minimize the differences between the simulated drainage volume below the root zone and the 1998 measured subsurface drainage volume from the lysimeters. The initial soil NO_3^- -N concentrations were also calibrated to minimize the difference between simulated and measured NO_3^- -N concentrations at the beginning of 1998. The predicted average monthly values were compared with the two-year (1999 and 2000) average monthly measured data from the lysimeters.

The results of this study show that the predicted average subsurface drainage volume consistently followed the average measured subsurface drainage volume for the 168UAN, 168PM, and 336PM treatments, with mean errors between measured and simulated of 9%, 3%, and -2%, respectively. The model predicted overall NO_3^- -N concentration in subsurface drainage for the 168UAN, 168PM, and 336PM treatments, with errors of 19%, -29%, and 9%, respectively. These results also show that there were no significant differences ($p = 0.05$) between two-year average measured and predicted NO_3^- -N losses in subsurface drainage, with mean errors of -4% and 7%, for 168PM and 336PM treatments, respectively. However, the model over-predicted NO_3^- -N loss in subsurface drainage for 168UAN treatment, with a percentage error of 25%. Results of this study led to the conclusions that GLEAMS model can be used as a viable management and decision-making tool to assess the impacts of long-term poultry manure application on water quality and agricultural production for Iowa soils. Also, further studies are needed in the inorganic fertilizer conversion rates and N uptake processes.

REFERENCES

Bakhsh, A., R. S. Kanwar, D. B. Jaynes, T. S. Colvin, and L. R. Ahuja. 2000. Prediction of NO_3^- -N losses with subsurface drainage water from manured and UAN-fertilized plots using GLEAMS. *Trans. ASAE* 43(1): 69-77.

Blanchet, L. 1996. Impact of lime application on transport of nitrate-nitrogen, atrazine, and cyanazine to subsurface drainage water: A lysimeter study. MS thesis, Iowa State Univ., Ames, Iowa.

Carsel, R. F., C. N. Smith, L. A. Mulkey, J. D. Dean, and P. Jowise. 1984. *User's Manual for the Pesticide Root Zone Model (PRZM), Rel. 1. EPA-600/3-84-109*. Athens, Ga.: U.S. Environmental Protection Agency.

Iowa Agricultural Statistics. 2001. Compiled by K. Sands and H. R. Holden. Iowa Agricultural Statistics Services. State Statistical Office of National Agricultural Statistics Service. Washington, D.C.: USDA.

Kanwar, R. S., J. L. Baker, and D. G. Baker. 1988. Tillage and split N-fertilization effects on subsurface drainage water quality and crop yields. *Trans. ASAE* 21(2): 453-461.

Knisel, W. G., ed. 1980. *CREAMS: A Field Scale Model for Chemical, Runoff, and Erosion from Agricultural Management Systems*. Conservation Service Report 26. Washington, D.C.: USDA.

_____. 1993. *GLEAMS: Groundwater Loading Effects of Agricultural Management Systems. Ver. 2.10*. UGA-CPES-BAED Publ. No. 5. Tifton, Ga.: University of Georgia, Coastal Plain Experiment Station.

Knisel, W. G., R. A. Leonard, and F. M. Davis. 1989. Agricultural management alternatives: GLEAMS model simulation. In *Proc. 1989 Summer Computer Simulation Conference, Austin, Tex.*, 701-706. San Diego, Calif.: Soc. Computer Simulation.

Leonard, R. A., W. G. Knisel, and D. A. Still. 1987. GLEAMS: Groundwater loading effects of agricultural management systems. *Trans. ASAE* 30(5): 1403-1418.

Minkara, Y. M., J. H. Wilhoit, C. W. Wood, and K. S. Yoon. 1995. Nitrate monitoring and GLEAMS simulation for poultry litter application to pine seedlings. *Trans. ASAE* 38(1): 147-152.

Reddy, K. R., R. Khaleel, M. R. Overcash, and P. W. Westerman. 1979. A nonpoint source model for land areas receiving animal manure: II. Ammonia volatilization. *Trans. ASAE* 22(6): 1398-1405.

Seligman, N. G., and H. van Keulen. 1981. PAPERAN: A simulation model of annual pasture production limited by rainfall and nitrogen. In *Simulation of Nitrogen Behavior of Soil-Plant Systems*, 192-221. M. J. Frissel and J. A. van Veen, eds. Wageningen, The Netherlands: Pudoc.

Sharpley, A. N., and J. R. Williams. 1990. *EPIC-Erosion Productivity Impact Calculator: 1. Model Documentation*. USDA-ARS, Technical Bulletin No. 1768. Washington, D.C.: USDA.

Shirmohammadi, A. 1990. Modeling as a management tool. In *Proc. Conf. Reducing Pollution from Nonpoint Sources. The Chesapeake Experience*, 60-62. CPB/TRS 53/90. Annapolis, Md.: U.S. EPA Region III. Chesapeake Bay Liaison Office.

Shirmohammadi, A., and W. G. Knisel. 1994. Evaluation of the GLEAMS model for pesticide leaching in Sweden. *J. Environ. Sci. Health A29(6)*: 1167-1182.

Shirmohammadi, A., B. Ulen, L. F. Bergstrom, and W. G. Knisel. 1998. Simulation of nitrogen and phosphorus leaching in a structured soil using GLEAMS and a new submodel, "PARTLE". *Trans. ASAE* 41(2): 353-360.

Sims, J. T., and D. C. Wolf. 1994. Poultry manure management: agricultural and environmental issues. *Adv. Agron.* 52: 2-72.

Singh, P., and R. S. Kanwar. 1995. Simulating NO_3^- -N transport to subsurface drain flows as affected by tillage under continuous corn using modified RZWQM. *Trans. ASAE* 38(2): 499-506.

Stone, K. C., P. G. Hunt, M. H. Johnson, and S. W. Coffey. 1998. GLEAMS simulation groundwater nitrate-N from row crop and swine manure water spray fields in the Eastern Coastal Plain. *Trans. ASAE* 41(1): 51-57.

Wagenet, R. J., and J. L. Hutson. 1986. Predicting the fate of nonvolatile pesticides in the unsaturated zone. *J. Environ. Qual.* 15(4): 315-322.

Yoon, K. S., K. H. Yoo, C. W. Wood, B. M. Hall. 1994. Application of GLEAMS to predict nutrient losses from land application of poultry litter. *Trans. ASAE* 37(2) 453-459.