

REFLECTIVITY MEASUREMENTS AT THE INTERFACE OF
TWO BONDED SOLID HALFSAPACES

M. de Billy and G. Quentin

Groupe de Physique des Solides
Universite Paris 7, Tour 23
2, place Jussieu
75251 Paris Cedex 05, France

INTRODUCTION

The reflectivity at the interface at two solid half-spaces was extensively studied in the past. Theoretical calculations of the reflection coefficients have been developed [1-3] in case of two elastic solids. The possibility of waves propagating along the interface was shown by Pilant [4] and experimentally pointed out [5,6]. The objective of this work is to measure the reflectivity at the interface between two bonded solid half-spaces, of longitudinal and transversal incident waves by taking into account the conversion of modes at the interface. The agreement with theory is good for S_{11} and S_{hh} coefficients. In case of an incident vertical transverse waves the reported measurements show some non-specular effect in the angular profile, which, by analogy with what is observed in case of liquid-solid interface, could be interpreted as the existence of a generalized leaky interface wave.

EXPERIMENTAL CONDITIONS

Experimental Arrangements

The angular distribution of the amplitude of the reflected signal was measured by a classical method including two transducers whose the polarizations were chosen according to the reflectivity coefficients involved. One of the two infinite samples has a half-cylindrical shape (Fig. 1). The transmitter and the receiver are in contact with the incident medium and rotate independently around the main axis of the half-cylinder. The transducers are coupled with an adaptative concave piece to insure a good contact between the front face of the transducers and the sample. By this way, compressional and transverse waves with different polarizations can be generated in the half-cylindrical medium. To check the validity of the experimental method, some preliminary measurements were done on the reflectivity at the solid-air interface. Our study will be limited to the case where the polarizations of the incident and reflected waves are identical. We shall define the reflectivity coefficients S_{11} , S_{vv} (or S_{vv}^{hh}) and S_{hh} (or S_{hh}^{hh}) whose the lower indexes indicate the polarizations of the incident and reflected waves. The experimental results are given in Figure 2 and agree with the theoretical calculations. The transverse wave is generated with a contact shear transducer and its direction of polarization is determined

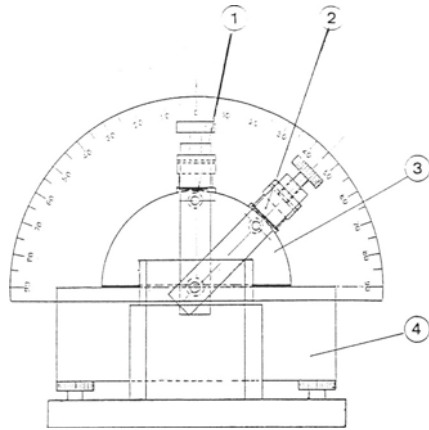

- 1 Transmitter
- 2 Receiver
- 3 Half-cylindrical incident medium
- 4 Substrate

Fig. 1. Schematic diagram of the experimental set-up.

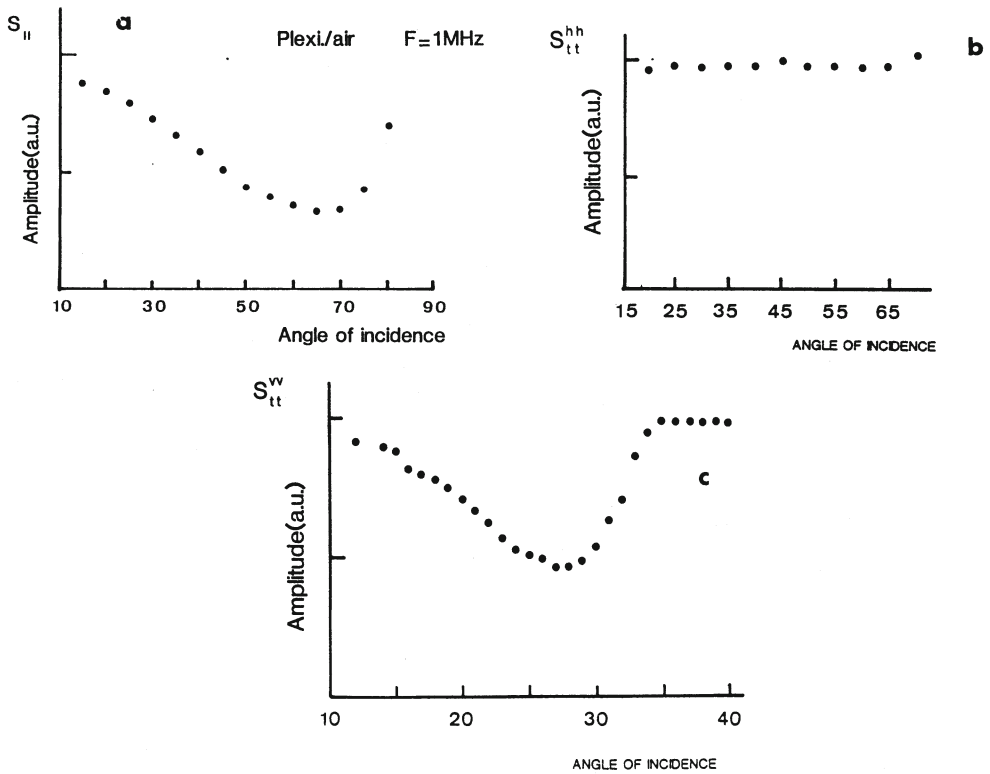

Fig. 2. Experimental reflectivity measurements by the Plexiglas-air interface at 1 MHz: a) S_{pp} coefficient; b) S_{hh} coefficient; c) S_{vv} coefficient.

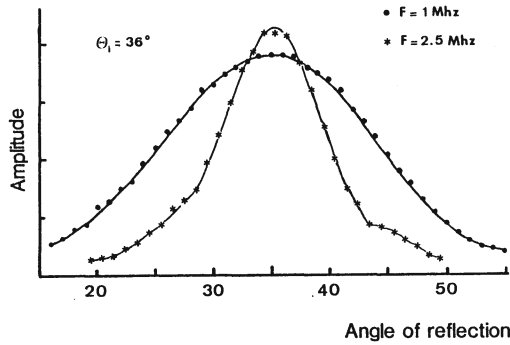

Fig. 3. Angular profiles showing the influence of the frequency on the aperture of the beam. (Case of the Plexi-copper interface for an angle of incidence of 36°).

in comparison with the sagittal plane. The vertical polarization (SV) is such that the displacements are included into the plane of incidence and the horizontal polarization (SH) is defined by the fact that the displacements are perpendicular to the incident plane. The Figure 3 illustrates the angular resolution performance of the set-up according in the central frequency of excitation of the transducers.

Description of the Samples

The samples were made of two isotropic semi-infinite bonded solids. The incident medium is a Perpex half-cylinder of 5 cm in diameter and 4 cm in height; the lower medium is a parallelepipedic support which is bonded with the upper medium with glue (coupling Sofranel) the thickness of which (e) is approximately few tens of micrometers. For any experimental conditions we had $e < \lambda$ (λ is the incident wave length in the incident medium). Different substrates were investigated during these experiments: brass, copper and stainless-steel.

RESULTS AND DISCUSSION

In this subsection we give the experimental variations of the amplitude specularly reflected at the interface. We consider this unnormalized quantity as proportional to the reflection coefficients.

S₁₁ Coefficients

The experimental data are given in Figures 4a and 5a for different combinations of two substrates: plexi-copper and plexi-steel. In the same figures are plotted the theoretical reflection coefficient R_{11} calculated for two solids in rigid contact. The agreement is qualitatively reasonably good if we take into account the aperture of the beam in the incident solid medium. No change due to the frequency was observed for these coefficients. The experimental evaluation of the longitudinal critical angles agree with the theoretical values obtained from the velocities given in Table 1.

Table 1. Velocities of the acoustic waves in the investigated solids.

	C_L	C_T	C_R	C_i^*
Copper	4600	2380	2212	2072
Stainless-Steel	5740	3112	2882	2720
Plexiglas	2670	1360	-	-

C_i^* designates the phase velocity of the interface wave.

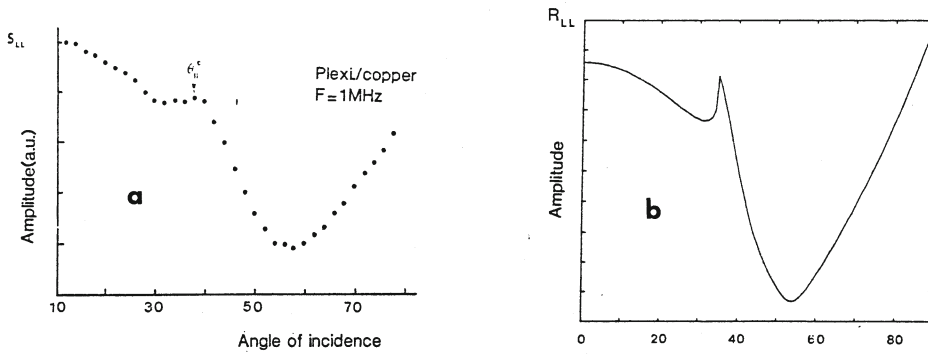

Fig. 4. Reflectivity measurements of a longitudinal incident beam at 1 MHz without conversion of mode: a) experimental data for a Plexi-copper interface; b) theory.

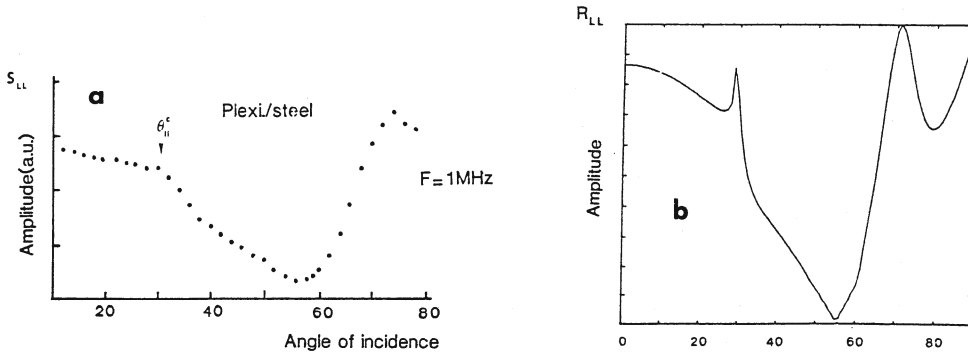

Fig. 5. Reflectivity measurements of a longitudinal incident beam at 1 MHz without conversion of mode: a) experimental data for a Plexi-stainless-steel interface; b) theory.

S_{hh} Coefficients

In these measurements, the transverse polarizations of the incident and of the reflected waves are horizontal. Typical reflectivity measurements are plotted in Figure 6. On these experimental plots, we distinguish two regions the limits of which vary according on the combinations of the two investigated solids: the first one spreads out from 0° to 31° or 41° and is characterized by a minimum; the second region is observed for higher angles of incidence and is characterized by a constant value of the amplitude of the reflected signal. The minima observed are broader than the theory predicts [3,7] because of the aperture of the beam and so it is difficult to evaluate with accuracy the transverse critical angle: $\theta_c^e = 25.8^\circ$ and 34.8° respectively for Plexi-steel and Plexi-copper interfaces, these values are calculated

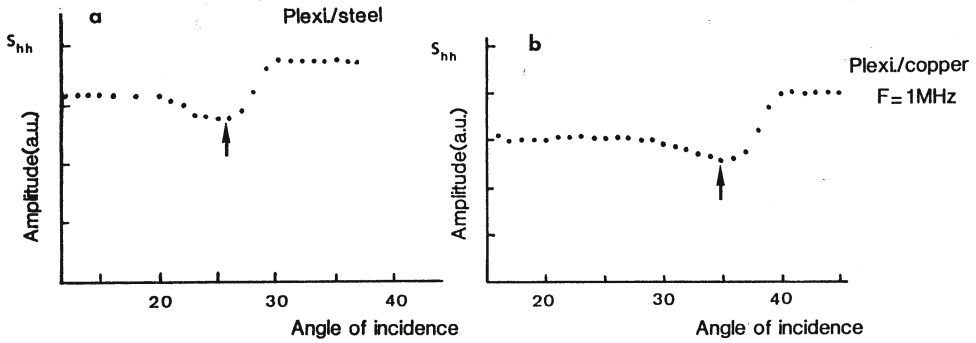

Fig. 6. Experimental data of the reflectivity measurements of an incident transverse beam (with horizontal polarization) at 1MHz without mode conversion: a-Case of a Plexiglas-steel interface; b-Case of a Plexiglas-copper interface.

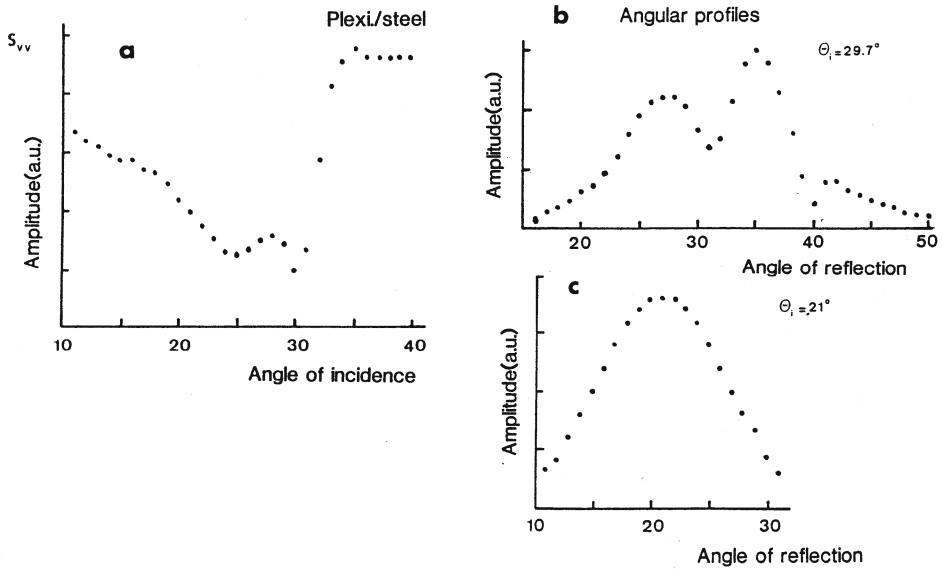

Fig. 7. a) Experimental reflectivity measurements of an incident S_{vv} beam at 1 MHz without conversion mode; b) angular profile at $\theta_i = 29.7^\circ$; c) angular profile out of the critical angles.

from the ratio of the transverse velocities of the two media-Cf, Table 1. A good way to evaluate experimentally the critical angles is to consider the angles at which minima exist: $\theta_i^c = 26^\circ$ and 35.5° respectively. These results agree reasonably well with the theoretical evaluation because there exists a very strong vertical jump at this critical angle and it is so possible to assimilate the critical angle values with the angular positions of the minima. This determination is of course indefinite but gives a reasonably good estimation. At high frequencies, the measurements should be more accurate.

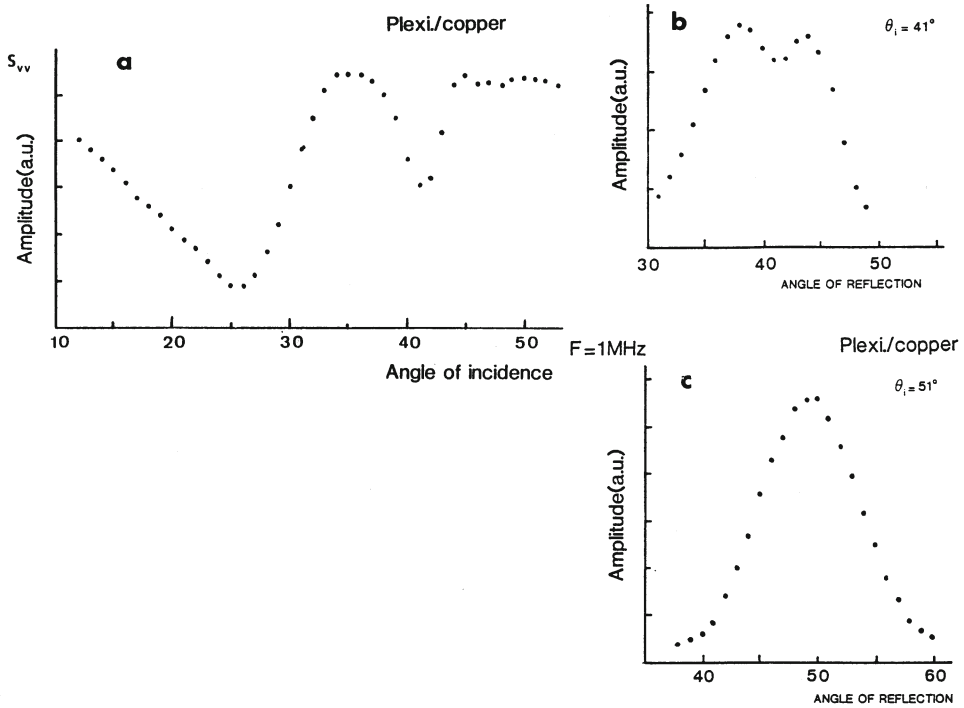

Fig. 8. a) Experimental reflectivity measurements of an incident S_{vv} beam at 1 MHz without conversion mode; b) angular profile at $\theta_i = 41^\circ$; c) angular profile out of the critical angles.

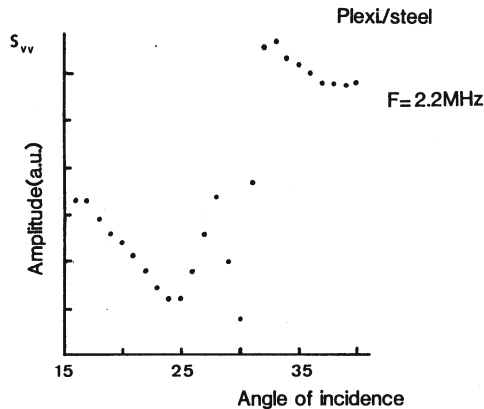

Fig. 9. Experimental reflectivity measurements of an incident S_{vv} beam at 2.2 MHz without conversion of mode.

S_{xy} Coefficient

Experimental Results

By rotating the receiver and the transmitter we changed the polarizations such that the displacements are inside the sagittal plane (vertical polarization). The measurements of the reflectivity are plotted in Figures 7a and 8a for two different interfaces. These plots agree well with the theory except the presence of a sharp minimum the position of which varies with the lower medium but not with the frequency. The minimum is deeper as the frequency increases (Fig. 9).

Discussion

The origin of these holes should be due to the excitation of a leaky interface wave propagating at the interface between the two media. The leaking effect is illustrated in Figure 7 b-c and 8 b-c where are compared the angular profiles obtained at the angles for which a minimum exists and for angles out of the critical angles. The introduction of the attenuation of the wave into the theoretical formulation should point out the existence of these minima. From the angular position of the critical angles, it is possible to evaluate the phase velocity of the leaky interface wave. The values are given in the fifth column of Table 1.

CONCLUSION

The reflectivity at the flat interface between two bonded solids has been experimentally studied. It was shown that in the configuration plexi-solid, the S_{11} and S_{AA} coefficients agree with the theory. The S_{uv} measurements pointed out the existence of a leaky interface wave which has to be studied and characterized by answering the questions: is it a bounded beam effect, what about the influence of the thickness of the adhesive, what happens if the thickness of the substrate diminishes, is there a frequency dependence, and what is the influence of the acoustical parameters of both media on the existence of this wave?

REFERENCES

1. W. G. Mayer, Ultrasonics, 62-68 (1965).
2. G. S. Murtry, Geophys. J. R. astr. Soc. 44, 389-404 (1976).
3. W. M. Ewing, W. S. Jardetsky, and F. Press, Elastic Waves in Layered Media (McGraw-Hill, New York, 1957).
4. W. L. Pilant, Bull. of the Seismo. of America 62, 285-299 (1972).
5. R. O. Claus and C. H. Palmer, Appl. Phys. Letters 31, 547-548 (1977).
6. D. A. Lee and d. M. Corbly, IEEE Trans. on Sonics and Ultra, 24, 206-212 (1977).
7. B. A. Auld, Acoustic Fields and Waves in Solids, Vol. II (John Wiley and Sons-1973).