

2007

Integration and validation of a radio frequency identification (RFID) system and automatic sorting technology (AST) for real-time correlation of management and disease impacts on the performance of swine in field studies

Ruby Herseniada Destajo
Iowa State University

Follow this and additional works at: <https://lib.dr.iastate.edu/rtd>

 Part of the [Agriculture Commons](#), [Animal Sciences Commons](#), [Large or Food Animal and Equine Medicine Commons](#), and the [Veterinary Pathology and Pathobiology Commons](#)

Recommended Citation

Destajo, Ruby Herseniada, "Integration and validation of a radio frequency identification (RFID) system and automatic sorting technology (AST) for real-time correlation of management and disease impacts on the performance of swine in field studies" (2007). *Retrospective Theses and Dissertations*. 14525.
<https://lib.dr.iastate.edu/rtd/14525>

This Thesis is brought to you for free and open access by the Iowa State University Capstones, Theses and Dissertations at Iowa State University Digital Repository. It has been accepted for inclusion in Retrospective Theses and Dissertations by an authorized administrator of Iowa State University Digital Repository. For more information, please contact digirep@iastate.edu.

Integration and validation of a radio frequency identification (RFID) system and automatic sorting technology (AST) for real-time correlation of management and disease impacts on the performance of swine in field studies

by

Ruby Herseniada Destajo

A thesis submitted to the graduate faculty
in partial fulfillment of the requirements for the degree of
MASTER OF SCIENCE

Major: Veterinary Preventive Medicine (Swine Production Medicine)

Program of Study Committee:
Locke A. Karriker, Co-major Professor
Jeffrey J. Zimmerman, Co-major Professor
Annette M. O'Connor

Iowa State University

Ames, Iowa

2007

Copyright © Ruby Herseniada Destajo, 2007. All rights reserved.

UMI Number: 1443058



UMI Microform 1443058

Copyright 2007 by ProQuest Information and Learning Company.
All rights reserved. This microform edition is protected against
unauthorized copying under Title 17, United States Code.

ProQuest Information and Learning Company
300 North Zeeb Road
P.O. Box 1346
Ann Arbor, MI 48106-1346

TABLE OF CONTENTS

ABSTRACT.....	iv
CHAPTER 1. GENERAL INTRODUCTION.....	1
Introduction	1
Thesis Organization.....	1
CHAPTER 2. TALKING RFID.....	2
Abstract	2
Introduction	2
History	3
The Technology	4
The Operation	8
Animal Applications	10
Bibliography.....	12
CHAPTER 3. ASSESSING THE USE OF RADIO FREQUENCY IDENTIFICATION (RFID) SYSTEM WITH AUTOMATIC SORTING TECHNOLOGY (AST) FOR MONITORING WEIGHTS OF FINISHING PIGS IN FIELD STUDIES.....	20
Abstract.....	20
Introduction.....	21
Materials and Methods.....	22
Results.....	27
Discussion.....	31
Acknowledgment.....	37
References.....	38
CHAPTER 4. USE OF RFID TAGS AND AUTOSORT SCALES IN MONITORING GROWTH OF PRRS-INFECTED FINISHING PIGS.....	47
Acknowledgment.....	54
References.....	54
CHAPTER 5. GENERAL CONCLUSION.....	59
General Discussion	59
ACKNOWLEDGMENTS.....	61

ABSTRACT

A cohort study using RFID system with automatic sorting scales to monitor weights of swine finishers was conducted. Weight data from 2,057 barn-raised pigs were monitored to assess tag retention, frequency of scale visits, data capture, and outlier detection. Results showed tag loss rate highest around 12th and 13th week of finishing; crowded pens more likely to lose tags; and pen-averaged daily scale visits ranged from 2.45-2.74 visits. Using a system that removes outliers and inaccurate weights, weight data from 100 randomly selected swine finishers in four time-points were evaluated. Sample pigs were bled monthly for three months, tested for PRRS virus infection using ELISA and RT-PCR, and grouped based on test results. Repeated measures analysis revealed significant interaction between group and time ($P=0.014$). The group (2 head) with the largest mean final weight (224.38 ± 14.79) was negative in both tests while the group (28 head) with the lowest mean final weight 207.56 ± 4.29 was positive in either test for three time-points.

CHAPTER 1. GENERAL INTRODUCTION

Introduction

Demand for the use of radio frequency identification technology (RFID) in animals is increasing. Currently used to obtain information without the line of sight and subsequent data storage in microprocessor-controlled device, RFID was paired with automatic sorting technology (AST) which utilizes electronic scales for automatic weight recording and sorting as pigs pass through. The tandem aims to improve efficiency in monitoring individual weights of finishing pigs throughout the production period. This thesis explored the combined use of these technologies to monitor pig weights for swine production research.

Thesis Organization

The thesis consists of four chapters. Chapter 1 is a general introduction of the study. Chapter 2 consists mainly of a literature review on RFID technology organized as one paper for submission to the *Animal Health Research Reviews* journal. Chapter 3 is a paper entitled "Assessing the use of radio frequency identification (RFID) system with automatic sorting technology (AST) for monitoring weights of finishing pigs in field studies" for submission to the *Journal of Swine Health and Production*. Chapter 4 is a short communication for the *Veterinary Record* journal on the "Use of radio frequency identification (RFID) system and automatic sorting technology (AST) to monitor growth of PRRS-infected pigs." In chapter 5, general conclusions are discussed.

CHAPTER 2: TALKING RFID

A review article to be submitted to the Animal Health Research Reviews journal

Ruby Destajo, Locke Karriker, Jeffrey Zimmerman and Annette O'Connor

Department of Veterinary Diagnostic and Production Animal Medicine, College of
Veterinary Medicine, Iowa State University, Ames, Iowa, USA

Abstract

Trends in globalization and incorporation of more technological advances in the animal industry have complicated the otherwise simpler issue on animal production. As animal food producers are finding ways to increase production to meet increasing market demands, they are also challenged by the difficulty in monitoring individual animals or herds. One of the pervasive shifts for adoption is the application of RFID technology. As the global attraction to RFID-based systems is primarily related to inventory management, the animal industry can benefit largely from the data management capability and flexibility of this system.

Introduction

Radio Frequency Identification (RFID) technology is a form of automated data collection system that wirelessly captures and moves data or identifies persons or inanimate objects

using radio waves (*Understanding key issues in radio frequency identification*, 2004). It utilizes microchips which act as transponders (transmitters/ receivers) that always listen for radio signals from transceivers (readers) and respond by transmitting embedded information (Granneman, 2003). Information can be of various forms but the most common method for identification is a series of numbers that are unique to a person or object (*General RFID information*, n.d.). RFID is one of the technologies (eg. bar code, smart cards, biometrics, magnetic strips) referred to as Automatic Identification and Data Capture (AIDC), devoted to automatic data collection and subsequent storage in a microprocessor-controlled device, such as the computer (<http://www.bitpipe.com/tlist/AIDC.html>). Although the concept is similar to bar code identification, RFID does not require line-of-sight identification and reading can be done at greater distances than that necessary for bar code scanning (<http://www.webopedia.com/TERM/R/RFID.html>).

History

An old technology in a modern setting, the basic concept was said to be born in the first quarter of the 20th century, roughly the 1920s (*RFID for beginners*, n.d.). It was developed as a means of communication between robots (Dargan *et al.*, n.d.). A similar technology was developed by the British and used during WWII by the Allies to distinguish between friendly and enemy planes (*History of RFID tags*, n.d.). According to Landt (2001), the development of the radar (which works by sending radio waves and identifying object position through reflected radio waves) and incorporation with radio broadcast technology started RFID development. Early theories on RFID system were published by Harry Stockman in 1948 in a

paper entitled “Communication by Means of Reflected Power” (as cited in Landt, 2001). The RFID concept then slowly gained ground but by the 1970s, a number of organizations including research and academic institutions were working on it. RFID work was primarily developmental and interests were more centered on animal identification and tracking, transportation and logistics, security systems, supply chain and management (Chatterjee *et al.*, 2004).

The Technology

The main components of the RFID system are: an antenna, an electronically programmed transponder (RF tag), and a transceiver with a decoder (reader or interrogator) (*What is radio frequency identification (RFID)*, n.d.). Antennas serve as a channel of communication between the transponder (RF tag) and transceiver (reader or interrogator) during data acquisition. They can be placed in strategic areas where they can pick up tag data from a passing person (animal) or a moving object (*What is radio frequency identification*, n.d.), or they can be packaged with the transceiver and decoder in a reader (*RFID overview*, n.d.). The RFID reader, which is controlled by microprocessor or digital signal processor, captures data from tags through its antenna by detecting backscatter modulation (Sorrell, 2002), i.e., the signal reflected by the tag is modulated and eventually detected by the receiver’s antenna, establishing a communication between the two (*Backscatter RFID systems*, 1995). Readers are currently available in various forms and have a variety of features. They can be portable (hand-held), embedded in an electronic equipment, or fixed at designated read zones (*RFID basics*, n.d.).

A “transponder” (a contraction of transmitter and responder) is defined as a wireless communications device that receives and responds to a signal (http://whatis.techtarget.com/definition/0,,sid9_gci213219,00.html). An RFID tag or transponder (Fig.1) has three main parts: antenna, silicon chip, and substrate or encapsulation material (*Anatomy of a spy chip*, 2004; Gearoid, 2003). The chip stores electronic information about the person or object to which the tag is attached; the antenna is responsible for transmitting this information to the reader in the form of radio waves; and the substrate (packaging) encases the chip and antenna so tag can be attached to a physical object (US Department of Defense, n.d.). The tag’s tiny chip is an integrated circuit that contains all the electronics. Its coiled antenna comprises the rest of the tag. The material (substrate) on which both the chip and antenna are mounted can be made of paper, PVC or PET (Teflon) (Kabachinski, 2005).

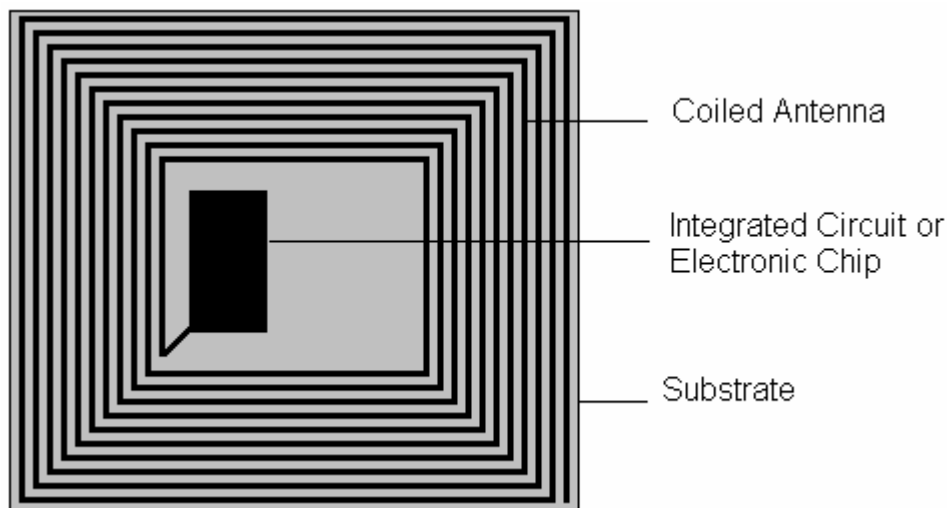

Figure 1. Basic components of an RFID tag (based on the description given by Gearoid, 2003).

RFID tags come in different types and sizes but are distinguished by function as active or passive and read/write or read-only (Gearoid, 2003). Data in read-only tags can be read but cannot be changed or edited whereas data in read/write tags can be modified as long as the tag is within the reader's range (*RFID*, n.d.). Based on its power source, RFID tags can be classified as passive, semi-passive, or active. The passive RFID tag does not have an internal power source. Instead, it draws power from the electromagnetic field formed when its antenna connects with radio waves sent by the reader, to energize the circuits of the chip and send back information to the reader in the form of radio-frequency waves (*How does RFID work?*, n.d.; *How does an RFID system work*, n.d.). Although this step requires a strong signal from the reader, the signal strength the tag returns is limited to low levels because of little energy, and therefore a passive tag needs to stay within the limited effective reader range of 3 meters or less and must not pass the read zone at high speed (Technologies for real-time supply chain visibility, 2002). Passive systems have limited data storage capacity, are not suited for sensor data collection, and have limited multi-tag communication capabilities (Naval Sea Systems Command, 2004). Communication with a number of tags decreases passive tag efficiency. Due to the limited read range, identifying multiple tags needs substantial interaction between the reader and the tag and this invites a great deal of interference from other tags, further increasing the duration of the operation (*Radio frequency identification overview*, n.d.). Despite these constraints, passive tags have longer lifespan since they do not require batteries. They may have a useful life of twenty years, are smaller in size and generally cheaper than the active type of RFID tags (*Passive RFID tag*, n.d.).

A similar type called semi-passive RFID tag, has a battery to run the circuits of the chip but still draws power from the reader when communicating (*How does RFID work?*, n.d.). Semi-passive tags do not require strong incoming signals so the reader's antenna can be optimized for backscatter (reflected) signals allowing these tags to have quicker response and higher reading ratio than passive RFID tags (*Types of RFID tags*, n.d.). Even if they do not have active transmitters, they can monitor inputs from sensors and control outputs, making them useful in applications such as alarms, seals or thermostats (*Radio frequency identification tags: description*, n.d.).

In contrast, an active RFID tag has its own power source and a transmitter (Haagense, 2004). It can work on very weak signals and return strong signals back to the reader as well as support multi-tag collection properties (Technologies for real-time supply chain visibility, 2002). They are typically read/write and have larger data storage capacity (up to 1MB of memory) (*Spectrum-enabled RFID tags store and share data*, 2004). Active tags have longer read range (eg. 85 meters) and can send data at designated times or at certain locations which makes them particularly useful in monitoring valuable items under harsh environmental conditions (*RFID active tags*, n.d.). These additional features make active tags heavier, more expensive, with limited life spans (Tadduni & Haghghat, n.d.). Some batteries, however, can last up to 10 years or 4-5 read/write operations before expiring (*Electromagnetic data capture*, n.d.). There has been a reported increase of active tag applications between 2004 and 2005, highlighting their use in cars and trucks for non-stop tolling as well as tracking prisoners on parole, high-risk patients and invalids, and freight containers on land and sea (*The market for active RFID tags*, 2005).

Since several permutations of tags are possible, the Auto-ID Center, a non-profit collaboration between academia and private companies, established a Class Structure for tags: Class 1 or Class 0 (read-only, passive identity tags); Class 2 (passive tags with additional functionality like memory or encryption); Class 3 (semi-passive tags which may support broadband communication); Class 4 (active tags may be capable of broadband or peer-to-peer communication with other active tags in the same frequency band, and with readers); and, Class V (tags that are essentially readers because they can power up lower classes of tags (I,II,III) and communicate with class IV and with each other). This classification is based on the practical application and related cost of tags (Sarma & Engels, 2003).

The Operation

The basics of signal transmission involving radio waves can be compared to the use of mirrors in communicating messages by flashing the sun's reflection in a sequence of codes (eg. Morse Code) which is known to the recipient, allowing messages to be relayed from the sender to the receiver through the air, without any form of physical contact (*What is RFID*, n.d.). The reader initiates the whole process by sending radio waves. A tag that enters this radio frequency (RF) region receives the signal through its coil, forming a magnetic field. The RF tag responds to this signal from the reader by "reflecting the carrier wave and putting a signal into that reflection", a technique known as backscatter. The reader then converts these new waves into digital data and sends them to a computer system for logging and processing (*RFID – the technology*, n.d.). It controls the protocol in reader-tag communication, receives and decodes information from tags, transmits ID and data to a host

computer, directs the tag to store data in some cases, and ensures message delivery and validity (*RFID air interface standards*, n.d.). It may also receive data from other input devices (eg. vehicle detector, controlling gates and lights) (*RFID Overview*, 2001). Passive RFID systems are often utilized for their low-cost, modest functionality. Commonly used frequencies for these devices are low frequency (LF, 125-134 KHz), high frequency (HF, 13.5 MHz), ultra high (UHF, 868-928 MHz), and microwave (2.45 GHz). The most popular frequency for lowest-cost tags is 13.5 MHz and is used as the basis for several international standards (*RFID system frequencies*, 2004).

Read ranges vary in different frequencies and depend upon the surface on which the tag is mounted. RF tags in the LF-HF band have a range of 1 to 18 inches, while passive UHF tags can reach up to 20 feet, and microwave tags can reach 1 to 6 feet (Goldman & Crawford, 2003). Lower frequencies generally have shorter associated ranges but offer better penetration of materials, whereas higher frequencies, although they have better ranges, are prone to greater physical interference (*Technical characteristics of RFID*, n.d.). Tags with long read range are preferred in elk herd tracking for more efficient data gathering and closer monitoring of product quality (*Elk Herd Tracking*, 2006). Low frequency tags have large-sized antenna to maximize transmission but slow transmission speed and can work well in the presence of obstacles which make them ideal for tagging livestock, beer barrels, and other inventory control (*A comparison of tag frequencies*, 2005). RFID tags used in livestock animals are based on a low-frequency protocol as established by the International Organization for Standardization (ISO) (Kevan, 2005). Tags working at a frequency of 13.5 MHz are preferred for smart cards and airline baggage tags while UHF and microwave tags

are often used for tracking and freight due to their longer range and small size (*Tag frequencies*, 2005). Unlike low frequency tags, higher frequency tags support faster data transfer and have anti-collision properties (PennTAP, n.d.). Anti-collision (ways to prevent interference of radio waves from one device with another) property prevents a number of tags present in the read zone to send signals at the same time and confuse the reader (*RFID tag collision*, n.d.).

Animal Applications

RFID tags were first used in livestock to track cattle (Bonsor, n.d.). Early animal transponders were tested on dairy cows to monitor health and ovulation status (*RFID: the early years 1980-1990*, n.d.), and also implanted in high priced horses to “deter fraud in thoroughbred management” (Beigel, 1997). In wildlife research and conservation, small, implantable passive tags were initially used in tracking fishes, a practice which later included mammals, reptiles, amphibians and other animals (<http://www.biomark.com/index.htm>).

RFID tags were also used with other devices to study patterns of animal movement and behavior in their habitat. A study involving RFID implanted in penguins, for example, was complemented by a weighbridge data-logger that recorded animal’s identity, weight, time and direction of travel each time a penguin crosses the weighbridge (Beigel, 1997).

Passive and active RFID microchips designed to determine animal body temperature have been recently introduced in the market. Subdermal, biosensor RFID microchips such as those manufactured by Digital Angel Corporation, are syringe-implantable passive transponders

with newly developed integrated circuit equipped with a sensor that measures and monitors animal temperature that is then read using handheld scanners, and are currently sold in the companion pet market in the United Kingdom, Japan, and the Philippines as well as the equine market in South Africa (*Biothermal implants for Japanese pets*, 2004; *Patent on RFID Microchip for Animal Temps*, 2006). Swedberg (2006) has reported that TekVet, an agriculture technology company, has linked with IBM in its active RFID cattle-tracking system that utilizes battery-powered 418 MHz RFID tags that are attached to the animals' ears with temperature sensors inserted into the ear canal and transceivers that are attached to poles or building walls in producers' lot. Animals within the average range of 300 to 500 feet from the transceivers can be monitored and hourly information on the unique identification number and temperature of each animal captured by the transceivers are relayed to the IBM-hosted data center where data can be accessed on-line, through a 900 MHz private satellite communications network (Swedberg, 2006).

The growing demand for pet tagging in the U.S. has now made it easier for pet shelters to reunite lost pets with their owners. However, use of RFID tags operating at different frequencies and not readable by all readers complicates the usefulness of this application. In November 2005, a legislation about RFID use in pets was approved in the House of the Representatives and House of Senate (House Report 109-255 that accompanied the 2006 Appropriations Bill HR 2744) to "develop the appropriate regulations that allow for universal reading ability and best serve the interests of pet owners" (O'Connor, 2005).

A number of issues has also cropped up that stimulated the demand for the use of RFID in livestock and other animals. Tracking livestock and other animals is no longer confined to

plain identification or ownership but also for health and public safety issues. The Portuguese government planned on tagging their estimated 2 million dogs by 2007 to control rabies in their country (Hines, 2004). USDA officials shipped 26,000 RFID tags in 2005 to monitor and help prevent spread of diseases (eg. mad cow disease in cattle, chronic wasting disease in deer and elk) to domesticated herds (Moore, 2005). In April 2006, USDA has also announced the plan for implementation of National Animal Identification System (NAIS) requiring identification of all livestock species to allow for tracking back into the herd of origin in 48 hours (Snelson, n.d.). Complete traceability from the barn to the plate has become the major issue faced by food and livestock producers as threats concerning avian flu, mad cow disease, food contamination, and bioterrorism continue (*RFID in the livestock industry*, 2005).

Application of RFID technology in livestock operations offers a big benefit in livestock traceability. This allows producers to automatically collect, store, and report information on individual animals, personnel and husbandry practices. Specific benefits include inventory control and supply chain management; carcass-tracking and food safety verification; and productivity and labor efficiency reports (*VeriChip maker's food safety efforts*, 2003).

Bibliography

A comparison of tag frequencies (2005, October 1). *RFID Gazette* [serial online]. Retrieved January 3, 2006, from http://www.rfidgazette.org/2005/10/a_comparison_of.html

Anatomy of a spy chip (2004). Retrieved January 3, 2006, from P2PNet Web site:

<http://p2pnet.net/story/2830>

Backscatter RFID systems (1995). *Hewlett-Packard Journal*, vol. 95. Retrieved February 14,

2006, from <http://www.hpl.hp.com/hpjournal/95dec/dec95a12aa.pdf>

Beigel M (1997). RFID in Antarctica. Retrieved January 3, 2006, from Beigel Technology

Corporation Web site: <http://www.beitec.com/penguin.htm>

Biothermal implants for Japanese pets (2004, November 16). Retrieved September 8, 2006,

from Cybertime Web Site: <http://www.cybertime.net/~ajgood/biothermo.html>

Bonsor K (n.d.). How RFID works. Retrieved January 3, 2006, from HowStuffWorks Web

site: <http://electronics.howstuffworks.com/smart-label.htm/printable>

Chatterjee PW, Wolfe P, Park S, and Choi J (2004). *Evaluation of using RFID passive tags*

for monitoring product location/ownership. Retrieved November 8, 2005, from

Arizona State University Web site: www.public.asu.edu/~rchatte/paper464.pdf.

Dargan G, Johnson B, Panchalingam, and Stratis C (n.d.). *The use of radio frequency*

identification as replacement for traditional barcoding. 45-877 Final Project:

Strategic uses of information technology. Retrieved January 2, 2006, from

<http://www.andrew.cmu.edu/user/cjs/tech.html>

Electromagnetic Data Capture (n.d.). Retrieved January 2, 2006, from [http://et.wcu.edu/](http://et.wcu.edu/aidc/Technologies/electr.htm)

[aidc/Technologies/electr.htm](http://et.wcu.edu/aidc/Technologies/electr.htm)

Elk Herd Tracking (2006, January 4). *RFID News and RFID Operations* [serial online].

Retrieved January 7, 2006, from [http://www.rfidnews.org/weblog/2006/01/04/elk-](http://www.rfidnews.org/weblog/2006/01/04/elk-herd-tracking/)

[herd-tracking/](http://www.rfidnews.org/weblog/2006/01/04/elk-herd-tracking/)

Gearoid M (2003). *Radio frequency ID tags: what are they, how they can be used, and how production costs can be reduced*. Retrieved November 15, 2005, from Automation Research Centre, University of Limerick Web site: [www.ul.ie/~arc/Radio Frequency ID Tags.pdf](http://www.ul.ie/~arc/Radio%20Frequency%20ID%20Tags.pdf)

General RFID information (n.d.). *RFID Journal*. Retrieved November 12, 2005, from <http://www.rfidjournal.com/faq/16/49>

Goldman A and Crawford K (2003, December 23). RFID Primer: where the WLAN hits the RFID fan. *Wi-fi Planet* [serial online]. Retrieved December 30, 2005, from <http://www.wi-fiplanet.com/tutorials/article.php/3292521>

Granneman S (2003). RFID chips are here. *Security Focus* [serial online]. Retrieved November 8, 2005, from <http://www.securityfocus.com/columnists/169>

Haagense S (2004, February). When safety matters: using active RFID down the mines. *Sensors Express*. Retrieved January 2, 2006, from <http://www.sensorsmag.com/articles/0204/34/main.html>

Hines M (2004, July 24). Portuguese pooches to get radio-tagged. *ZDNet* [serial online]. Retrieved November 13, 2005, from http://news.zdnet.com/2100-3513_22-5281608.html

History of RFID tags (n.d.). Retrieved January 2, 2006, from Wikipedia Web site: http://en.wikipedia.org/wiki/RFID#History_of_RFID_tags

How does an RFID system work (n.d.). *RFID Journal*. Accessed November 12, 2005, from <http://www.rfidjournal.com/faq/17/58>

How does RFID work? (n.d.). Retrieved November 12, 2005, from RFIDa Web site: <http://www.rfida.com/rfidtech.htm>

- Kabachinski J (2005). An introduction to RFID. *Biomedical Instrumentation and Technology*. Retrieved November 15, 2005, from www.aami.org/publications/BIT/2005/ITMA05.pdf
- Kevan, T (2005, January 13). RFID-based livestock tracking systems tailor supply to demand. Retrieved February 14, 2006, from Frontline Solutions Web site: <http://archives.frontlinetoday.com/frontline/article/articleDetail.jsp?id=142388>
- Landt, J (2001). *Shrouds of time - the history of RFID*. Retrieved January 2, 2006 from AIM Global Web site: http://www.aimglobal.org/technologies/rfid/resources/shrouds_of_time.pdf
- Moore J (2005, April 18). RFID's positive identification: wireless ID apps gaining foothold beyond military. Retrieved November 13, 2005, from FCW Web site: <http://www.fcw.com/article88603-04-18-05-Print>
- Naval Sea Systems Command (2004, September 23). *Radio Frequency Identification: technology overview and applications*. The Government Wireless and Mobile Computing Conference and Exhibition, Washington, D.C. Retrieved January 3, 2006, from http://www.e-gov.com/events/2004/gwmc/downloads/Wireless_PEP-4_BAH.pdf
- O'Connor MC (2005, November 10). U.S. Bill Includes RFID Provision for Pets. *RFID Journal* [serial online]. Retrieved November 13, 2005, from <http://www.rfidjournal.com/article/articleview/1976/1/1/>
- Passive RFID tag (or passive tag)* (n.d.). Retrieved November 12, 2005, from Technovelgy Web site: <http://www.technovelgy.com/ct/Technology-Article.asp?ArtNum=47>

PennTAP RFID Overview (n.d.). The Pennsylvania Technical Assistance Program. Retrieved September 27, 2005, from http://www.personal.psu.edu/staff/c/a/cac31/rfid_rv2.ppt

Radio frequency identification overview (n.d.). Retrieved January 3, 2006, from CDO Technologies Web site: http://www.cdotech.com/cdocorporateportal/Portals/0/website/documents/RFID_Overview.pdf#

Radio frequency identification tags: description (n.d.). Retrieved November 8, 2005, from Pacific Northwest National Laboratory Web site: <http://availabletechnologies.pnl.gov/securityelectronics/rftagsdescription.stm>

RFID (n.d.). Retrieved January 2, 2006, from International Paper Knowledge Center Web site: <http://glossary.ippaper.com/?req=knowledge/article/489&catitemid=38>

RFID Active Tags (n.d.). Retrieved November 8, 2005, from Active Wave Web site: http://www.activewaveinc.com/products_active_tags.html

RFID air interface standards (n.d.). Retrieved December 30, 2005, from High Tech Aid Web site. Available at: <http://www.hightechaid.com/standards/18000.htm>

RFID basics (n.d.). Retrieved November 11, 2005, from Zebra Web site: http://www.zebra.com/id/zebra/na/en/index/rfid/faqs/rfid_basics.html#FAQ_0004

RFID for beginners (n.d.). Retrieved January 2, 2006, from The Money Vibe Web site: <http://www.themoneyvibe.com/rfid.html>

RFID in the livestock industry (2005, September 29). *RFID Gazette* [serial online]. Retrieved February 14, 2006, from http://www.rfidgazette.org/2005/09/rfid_in_the_liv.html

RFID overview (n.d.). Retrieved March 28, 2006, from Smartcode Corp. Web site: http://www.smartcodecorp.com/solutions/rfidi_overview.asp.

RFID Overview: Introduction to radio frequency identification (2001, March 4). Intermec

White Papers. Retrieved December 30, 2005, from http://www.intermec.com/eprise/main/Intermec/content/Products/Products_ListFamily?Category=RFID

RFID system frequencies (2004, May 20). Retrieved December 30, 2005, from ID Tech Ex

Web site: <http://www.idtechex.com/products/en/article.asp?articleid=7>

RFID tag collision (n.d.). Retrieved January 3, 2006, from Technovelgy Web site:

<http://www.technovelgy.com/ct/Technology-Article.asp?ArtNum=57>

RFID: the early years 1980-1990 (n.d.). Retrieved January 10, 2006, from The Eagle's Nest

Web site: <http://members.surfbest.net/eaglesnest/rfidhist.htm>

RFID – the technology (n.d.). Retrieved November 12, 2005, from High Tech Aid Web site:

http://www.hightechaid.com/tech/rfid/rfid_technology.htm

Sarma S and Engels DW (2003). On the Future of RFID Tags and Protocols. Technical

Report. *A Parallax View* [serial online], 1(5). Retrieved December 30, 2005, from <http://www.chainlinkresearch.com/parallaxview/sep03/home.htm>

Snelson H (n.d.). USDA describes plan for the national animal identification system.

Retrieved April 13, 2006, from American Association of Swine Veterinarians Web site: <http://www.aasv.org/news/story.php?id=1841>

Sorrell P (2002). *RFID basics. AN680*. Retrieved January 2, 2006, from

<http://ww1.microchip.com/downloads/en/AppNotes/00680b.pdf>

Spectrum-enabled RFID tags store and share data (2004). *Chips* [serial online]. Retrieved

January 3, 2006, from http://www.findarticles.com/p/articles/mi_m0OBA/is_3_22/ai_n6338488

- Swedberg C (2006, August 24). TekVet-IBM Cattle Tracker Uses Active RFID Tags, Satellite Communication. *RFID Journal* [serial online]. Retrieved September 22, 2006, from <http://www.rfidjournal.com/article/articleview/2612/1/1/>
- Tadduni J and Haghghat A (n.d.). RFID technology overview. Retrieved January 2, 2006, from www.smarthouse.duke.edu/downloads/rfid_joe.doc
- Tag frequencies* (2005, September 27). *RFID Gazette* [serial online]. Retrieved January 3, 2006, from http://www.rfidgazette.org/2005/09/tag_frequencies.html
- Technical characteristics of RFID* (n.d.). Retrieved December 30, 2005, from RSA Web site: <http://www.rsasecurity.com/rsalabs/node.asp?id=2121>
- Technologies for real-time supply chain visibility* (2002, May 24). Part 1: active and passive RFID: two distinct, but complementary. Retrieved November 8, 2005, from <http://uk.builder.com/whitepapers/0,39026692,60090534p-39000931q,00.htm>
- The market for active RFID tags* (2005, October 3). *RFID Gazette* [serial online]. Retrieved January 2, 2006, from http://www.rfidgazette.org/2005/10/the_market_for_.html
- Types of RFID tags* (n.d.). Retrieved November 12, 2005, from Wikipedia Web site: http://en.wikipedia.org/wiki/RFID#Types_of_RFID_tags
- Understanding key issues in radio frequency identification (RFID)* (2004). Retrieved November 12, 2005, from the Symbol Mobility Learning Center Web site: http://www.symbol.com/products/whitepapers/rfid_key_issues.html
- US Department of Defense (n.d.). *Radio frequency identification to enable supply chain*. Retrieved November 22, 2005, from ACQ Web site: http://www.acq.osd.mil/log/rfid/Supplier_Diversity_Marketplace_Presentation.pdf

- VeriChip maker's food safety efforts* (2003, December 29). *RFID News and RFID Operations* [serial online]. Retrieved February 11, 2006, from <http://www.rfidnews.org/weblog/2003/12/29/verichip-makers-food-safety-efforts/>
- What is radio frequency identification (RFID)* (n.d.). Retrieved November 12, 2005, from AIM Global Web site. Available at: http://www.aimglobal.org/technologies/rfid/what_is_rfid.asp.
- What is RFID* (n.d.). Retrieved November 11, 2005, from Barcodebook Web site: http://www.barcodebook.com/html/what_is_rfid_.html
- Wireless Sensors & Networks: Patent on RFID Microchip for Animal Temps* (2006, April 10). Retrieved September 8, 2006, from Tempsensors Web Site: <http://www.tempsensor.net/modules.php?op=modload&name=News&file=article&sid=545>
temperatures.com

**CHAPTER 3. ASSESSING THE USE OF RADIO FREQUENCY IDENTIFICATION
(RFID) SYSTEM WITH AUTOMATIC SORTING TECHNOLOGY (AST) FOR
MONITORING WEIGHTS OF FINISHING PIGS IN FIELD STUDIES**

A paper to be submitted to the Journal of Swine Health and Production

Ruby Destajo, Locke Karriker, Jeffrey Zimmerman and Annette O'Connor

Department of Veterinary Diagnostic and Production Animal Medicine, College of
Veterinary Medicine, Iowa State University, Ames, Iowa, USA

Abstract

A cohort study investigating the use of integrated radio frequency and identification (RFID) system and automatic sorting technology (AST) to monitor weights in a swine finishing herd was conducted from April to July 2005. Weight data from a total of 2,057 pigs raised in a commercial barn with pens designed for continuous automatic sorting were monitored. Factors affecting tag retention, frequency of scale visits, data capture, and outlier detection were assessed. Rate of tag loss was highest by the 12th and 13th week of finishing and more populated pens were more likely to lose tags than pens with fewer pigs. Average daily visits at pre-autosort were less than 1 but increased to between 2 and 3 visits during autosort phase. One-week data for four time points with monthly intervals were collected, assessed and averaged. Pre-autosort data points were fewer and many of the pig weights have wider ranges

than during automatic sorting phase of the electronic scales. Outliers and inaccurate weights were removed by establishing maximum and minimum weight limits for inclusion.

Introduction

Radio Frequency Identification (RFID) technology is a form of wireless automated data collection system utilizing radio waves.¹ This technology involves use of microchips acting as transponders (transmitters/responders) that always listen for radio signals from transceivers (readers) and respond by transmitting any embedded information.² Information can be of various forms but the most common is a series of numbers that identify a person or object.³ RFID is one of the technologies (eg. bar code, smart cards, biometrics, and magnetic strips) referred to as Automatic Identification and Data Capture (AIDC), devoted to automatic data collection and subsequent storage in a microprocessor-controlled device, such as computers.⁴ Although similar in some aspects to bar code identification, RFID does not require line-of-sight identification and reading can be done at greater distances than that necessary for bar code scanning.⁵

Automatic Sorting Technology (AST) is a new concept being implemented in swine farms today.⁶ It involves use of electronic scales that automatically weigh and separate growing pigs into 2 groups as they pass through the scale to access food or water.⁷ Each group can be given a different diet until the desired market weight is attained and the scale is typically programmed by the producer to set a predetermined cut-off weight to sort pigs into heavy and light pens or separate pigs for slaughter.^{8,9} Its software enables one to observe scale

activity, monitor weight data, or review growth curves from a remote computer location.¹⁰ This technology is employed to reduce sort loss by monitoring weight gain and earlier marketing of heavy pigs in the population.¹¹ Other benefits include uniformity of pig sizes, labor savings, and improved animal welfare.¹²

In this study, RFID technology was combined with AST, for real-time monitoring of pig weights, and the reliability of this system to capture information from a group of pigs in a commercial setting was determined. Factors associated with reliability such as tag retention, frequency of scale visits, data capture, and outlier detection were assessed.

Materials and Methods

Study Design. A total of 2,057 pigs between 10-11 weeks old were tagged in both barns. Pigs in barn 1 (pens 1 & 2) were tagged a day after their arrival while those in barn 2 (pens 3 & 4) were tagged in the nursery 1-2 days prior to their transfer to the barn. Pig weights, scale visits, and duration of tag transmission were monitored up to the first day of market.

Pig Barn. The study was carried out in two 1,000-head capacity commercial pig barns with slatted flooring and an automatic feeder system (Fig. 1). Each barn was designed to accommodate two 500-head capacity pens for continuous automatic sorting. Each pen was subdivided into one large loafing and two smaller feeding areas. Partitions between subdivisions were removable. Each pen had a complete set of automatic scale (Accu-Arm® Survey Scale™, Osborne Industries, Inc., Osborne, Kansas) linked to a computer in a

separate room that connected the two barns and served as an office. Pigs had to enter the scale to access feed and leave the feeding areas through separate exit gates. The one-way exit gate in each feed pen was provided with vertical bars which were hung loosely to allow exit of pigs after feeding to the loafing area but prevent their entry through these gates. Cup waterers were provided in both the feeding and loafing areas of each pen.

Acclimation (Pre-autosort) Period. Upon arriving at the barn, pigs underwent a 3-week acclimation phase, during which time they were allowed to move around and become acquainted with the location of the feeders and water troughs. Pen partitions between the loafing area and feeder pens were removed. The sort gate operation was manually set to keep the pneumatic entry gates at the front and sort gate at the back of each scale open continuously.

Training Period. Pigs were trained for 2-3 days to enter the scale after acclimation period. Partitions between the feeding and loafing areas were closed and pigs were trained to enter the scale by herding them to the scale's entrance. They were kept in the feeding areas for a certain amount of time (eg, few hours or a day) and released through exit gates. Air valve regulators were set at 25 psi to slow down movement of the scales' pneumatic entry gates and adjusted to 40 after the training period. The scales were then set to automatic sorting mode with the initial trigger weight set at 44 lbs. Pigs unable to navigate the system were temporarily placed in sick pens.

RFID tags. Osborne e-DISC™ RFID tags (FDX-B ISO 11784/5) were used in this study. These tags have a diameter of 30 mm (1.2 in), hole-diameter of 8.5 mm (0.33 in), thickness of 1.5 mm (0.06 in), and a resonance frequency of 134.2 KHz. They were fitted securely in female Snap-DISC™ tags and attached to the male, color-coded Allflex Global Large Hog ear tags (Allflex USA, Inc., Dallas, Texas) which were uniquely numbered for visual identification. The RFID numbers read by the scale reader were validated using a handheld reader (HOTRACO MicroID Pocket Reader 001, Osborne Industries, Inc., Osborne, Kansas) and matched with the visual identification number on the Allflex ear tag (Fig. 2).

Scales. Four automatic sorting scales incorporated with RFID system were used (Fig. 3). Each scale had pneumatic entry and sort gates, and a microprocessor-based controller wired to a computer. As an RFID-tagged pig entered the scale, the transponder's 15-digit numbers were transmitted to the controller and paired with the pig weight recorded during the visit. Data collected by the scale for a particular day were retained in the controller and were available for download to a computer until 12AM the following day. Data download was done twice a day since the amount of data the autosort scale's controller could accommodate was limited to 1200 visits. When saturated, the oldest data were overwritten with the newest entries. This would be reflected in the data as a gap from a few to several hours between successive entries.

Software. Daily Weigh TWO™ software (Osborne Industries, Inc., Osborne, Kansas) was used to access and display information obtained by automatic scales and RFID systems such as the fifteen-digit animal ID, time and date of scale entry and exit, and corresponding pen

number. The software was installed in a desktop computer that met the minimum requirements: Pentium 150 processor, 4 gigabyte hard drive, 1 RS232 Serial port (for direct connection only), MODEM (for remote connection only), color monitor, CDROM drive (for software installation), and Windows 95 or 98 OS. It was directly connected to the scales in the barn through an interface (P/N KI-00I100) (Osborne Industries, Inc., Osborne, Kansas). Data were downloaded from the autosort to the computer daily. Once a week, copies of all the files in the program's folder in the barn computer were backed up to another computer. Information referring to the site, barn, room and pens were viewed in the main form named "Location Manager" which also displayed the date, median weight, and the number of visits.

Data Conversion. Weight data originally written in a Paradox file (Corel Corp., Ottawa, Ontario, Canada) named "eventlog" by the Daily Weigh Two software was imported to a Microsoft® Access 2003 table. A query was made on the imported table and in SQL view, the original SQL statement was modified (to convert date and weight entries that appeared as a series of whole numbers) as follows:

```
SELECT EVENTLOG.[Tag No], DateAdd("s",EVENTLOG.[Entry Time],"1/1/1970")
ASNewEntryTime, DateAdd("s",EVENTLOG.[Exit Time],"1/1/1970") AS NewExitTime,
EVENTLOG.[Pig Weight]/4.545 AS [New Weight], EVENTLOG.[Pen No] FROM
EVENTLOG;
```

Additional queries were then made to the eventlog query and results of these queries were subsequently exported to Microsoft Excel® for further processing.

Tag Survival Modeling. The survival time or length of time that tags were detected from tagging to the first market (cut-off date) were recorded at weekly intervals. It was assumed that tags were lost randomly within the week. Survival analysis using the Kaplan-Meier (product-limit) estimator and Cox's proportional hazard model were performed in JMP (SAS Institute, Cary, North Carolina).

Estimated Scale Visits. Estimates on how often the pigs went through the scales were based on the number of raw weight data entries since actual scale visits were not monitored. Each of the pigs' recorded weight was identified as one trip through the scale. Estimates of the most and least number of scale visits made by any one pig in each pen, the average daily visits (ADV) of all pigs for each pen, and the highest and lowest ADV by any one pig were obtained. In addition, weekly ADVs (total ADVs for the week divided by 7) were computed to demonstrate variations in the number of recorded scale visits before and during automatic sorting.

Weight Data Evaluation. Five-number summaries, means, and standard deviations of each week of barn weight data from four time points were analyzed using JMP (SAS Institute Inc., Cary, North Carolina). Four time points with one-month interval were established to simulate four repeated sampling frequencies. Data at the first time point were recorded one week after tagging (pre-autosort phase) while those obtained at succeeding time points were recorded during automatic sorting. One-week weight data for each pig at each time point were examined for consistency. Outliers and suspected inaccurate weights were removed using

defined minimum and maximum weight limits based on each pig's average weight at each time point in a series of steps:

- (1) *Smallest Weight*. Identification of the smallest recorded weight in the population from one-week raw data at each time point.
- (2) *Removal of outliers*. The identified smallest weight value was added to the mean weight of each pig at each time point to set the individual maximum weight limit and subtracted from the mean weight to set the individual minimum weight limit. Weights of individual pigs that were lighter than the minimum cut-off and heavier than the maximum cut-off weights were excluded. Remaining weights were then averaged per pig and the population standard deviation (1SD) was determined for use in setting cut-off weights to eliminate inaccurate weights.
- (3) *Removal of inaccurate weights*. Inaccurate weights were removed using the mean weight per pig +/- 1 SD from step 2 to mark the maximum and minimum cut-off weights respectively, in a process similar to removal of outliers. The remaining weights were averaged per pig and designated as the final weight record for each pig for that time point.

Results

Pen populations at the beginning of the study were 505, 473, 542, and 536 in pens 1 through 4 respectively. Out of these totals, six pigs in barn 1 and eighty-eight pigs in barn 2 were not tagged. Six tags in the first barn and seven in the second barn were defective. The number of tags removed due to pig mortalities before the first finishers were sold were 82 (pen 1), 71

(pen 2), 48 (pen 3), and 66 (pen 4). In pen 1, additional 295 tags were lost resulting in 122 functional tags remaining at the beginning of the market period. This data for Pen 1 and the remaining pens is detailed in Table 1.

Comparisons of the length of tag detection (in weeks) were done between pens in each barn since ear tagging and the first-marketing dates were different in the two barns, Kaplan-Meier survival curves for the ear tags in pens 1 and 2 (barn 1) are shown in Fig. 4A and in pens 3 and 4 (barn 2) are shown in Fig. 4B. Out of the initial 437 tags, 10% of the tags (41 tags) were lost in pen 1 within the first 11 weeks. Number of tags lost weekly ranged from 1 to 12. These figures increased sharply to 87 by week 12 and 75 by week 13, bringing the total number of tag losses to 203 (49%). Additional 43, 36, and 13 tags were lost in weeks 14, 15 and 16 respectively, making the total tag losses to 295 (71%). Only 142 tags remained prior to first market. In pen 2, the initial number of tags was 396. Tags lost per week throughout the production until the first marketing date ranged from 1 to 4. Total tag loss was 29 (7%). Log-rank and Wilcoxon tests (Kaplan-Meier Survival Analysis) between groups showed that the median tag survival time in weeks varied significantly ($P > .0001$) between pen 1 (14 weeks) and pen 2 (>16 weeks). Cox proportional hazards model analysis also showed a significant difference between the two pens ($P > .0001$). Pigs in pen 2 were about half as likely as those in pen 1 to lose tags (risk ratio = 0.43).

In pen 3, the number of tags lost per week ranged from 1 to 13 in the first 11 weeks in pen 3 with a total of 40 (9.5%) tags lost. By weeks 12 and 13, 72 and 71 tags were lost respectively, increasing the total loss to 183 (44%). On week 14, an additional 43 tags (226

total, 54%) were lost prior to the first market. From the initial 419 tags, only 193 (46%) pigs had their tags when the first marketable pigs were sold. In pen 4, tags lost weekly ranged from 2 to 6 for 10 weeks, totaling 40 tags. By week 11, tags lost increased to 165 bringing the total tags lost to 205 (45%). In week 12, about 111 tags were lost (316 total, 70%). By the 13th and 14th week, 54 and 22 more tags were lost each week respectively. From an initial number of 450 tags, 392 tags (87%) were lost and only 58 (13%) retained their tags prior to first market. Log-rank and Wilcoxon tests suggested a high significant difference ($P > .0001$) in the median survival times of tags between pen 3 (14 weeks) and pen 4 (12 weeks). The Cox proportional hazards model analysis was also significant ($P > .0001$) and pen 4 pigs were approximately twice as likely to lose tags as pen 3 pigs (risk ratio = 2.01).

The estimated frequency of scale visits for each pen is shown in Table 2. The maximum numbers of visits made by any one pig on any one day were 22, 17, 16 and 16 in pens 1 to 4 respectively. The minimum number of visits made by the same pig is 0 for all pens. ADV for all pigs in pens 1 to 4 were 2.75, 2.43, 2.85, and 2.78 respectively. The highest ADV by any one pig in each pen were 7.62 (pen 1), 5.59 (pen 2), 5.74 (pen 3), and 5.42 (pen 4). The lowest ADV made by one pig is 0 for all pens.

Figure 5 shows the graph of the estimated ADVs per week in each pen over a period of sixteen weeks (barn 1) and 18 weeks (barn 2) is presented in Figure 5. In barn 1, the collected average daily visits (ADV) from pens 1 and 2 ranged from 0.35 to 0.69 before automatic sorting and these figures later changed in the fourth week when the scales were set to autosort and pen partitions closed. Estimated ADVs in scale 1 ranged from 1.69 to 3.05. In

scale 2, ADVs ranged from 0.82 to 1.34 before the RFID antenna was adjusted and ADVs increased from 2.47 to 3.64 after the adjustment. In barn 2, recorded ADVs from the scales in pens 3 and 4 ranged from 0.53 to 0.74 during acclimation period and increased from 1.98 to 3.46 after pen partitions were closed and automatic sorting started.

Table 3 lists the five-number summaries, means and standard deviations of one-week weight data collected at four time points. Step 1 descriptive statistics were obtained from the raw one-week weight data at each time point while those in steps 2 and 3 were computed after the removal of outliers and inaccurate weights, respectively. The smallest weight recorded in Time 1 was 25.96 lbs. The 25% percentile, median, and 75% percentile were 47.96 lbs, 59.19 lbs, and 72.17 lbs respectively. The maximum weight recorded was 140.81 lbs but this was replaced with 139.05 lbs in step 2, which remained the biggest in step 3. The smallest weight on the record was the same in step 2 but was changed to 27.72 lbs in step 3. Weights ranked as 25% percentile (48.40 lbs), median (58.53 lbs), and 75% percentile (69.97 lbs) in step 2 were changed to 49.28 lbs, 58.09 lbs, and 66.89 lbs respectively in step 3. The total number of observations (weight records) dropped from 2126 to 1919 after the removal of outliers (step 2) then to 1511 after step 3. As with Time 1, the five-number summaries obtained for Times 2, 3 and 4 either remained or were replaced by smaller or higher values while the number of observations decreased with the removal of weights regarded as “outliers” and “inaccurate.” Mean weight in Time 1 changed from 61.64 lbs to 59.77 lbs (step 2) and eventually to 58.47 lbs (step 3) while 1SD decreased from 17.93 lbs to 14.76 lbs (step 2) and to 12.39 lbs (step 3). As shown in Table 3, the gap of the values of the mean and 1SD between steps were closer in Times 2 to 4 than in Time 1. Total number of weight

observations in Time 1 (2,126) increased to 7,810 in Time 2 and further to 11,063 in Time 3 but decreased to 5,761 in Time 4.

Discussion

In the study of tag survival, tags were declared as lost on the day RFID-associated weights were no longer present in downloaded data. Visual inspection was also done to confirm the presence or absence of tags. The proportion of tags lost in all pens was less than 10% during the first 10 weeks of finishing. A sharp increase in tag losses was observed between 11th and 12th week in all pens except in pen 1 which could be due to increased pig strength and pig-to-pig contact about this period. It is important to note that these periods in barn 1 were two weeks ahead of barn 2. Assuming a fairly constant pen population, as pigs got older and bigger the space per individual would decrease. Tag chewing was observed to be the major cause of tag losses in the pens. It started as soon as the finishers were tagged and continued on every opportunity but younger pigs had more space to run away from the ones biting their ear tags and they had lesser ability to remove each other's ear tag. As they grew older and heavier with lesser space to move freely, it might have been easier for one pig to remove the ear tag of another. The proportion of tags lost after the 13th week was smaller and could be attributed to lesser number of tags remaining on the ears of finishers, providing less frequent opportunities for pigs to chew and remove them. In any event, all observations of pigs without tags revealed small holes remaining in the ear that would have required the tag to physically separate to be removed.

Higher pen density, on account of increased pig-to-pig contact, was also implicated as possible predisposing factor for increased rate of tag loss. Comparisons between pens in each barn have shown higher retention in pens with lesser population. Pigs in pen 2 (383) were half as likely to lose tags as in pen 1 (422) and those in pen 4 (461) were twice as likely to lose tags as pigs in pen 3 (452). Pen 2, which was least populated, lost the least number of tags prior to the first market of pigs while pen 4, the pen that consistently contained the most number of hogs towards the market period, lost the greatest number of tags as early as 11 weeks.

The frequency of scale visits were determined by counting the number of weight data for individual RFID tags and averaged daily. In barn 1, the average daily visits (ADV) in the first three weeks for each pig were less than 1. This was expected as majority of the pigs did not go through the scales during the pre-autosort phase. Partitions between the loafing area and the two smaller feeding areas were not yet placed by this time, providing the pigs more freedom of movement around each pen without having to go through the scale. By the end of the third week, pen partitions were placed and scales were set to automatically sort pigs as they exit the scales. This was reflected by the increase in ADV in both scales starting at week 4. However, Scale 2 ADV was consistently lower than that of Scale 1 until week 12. After this discrepancy was noticed and the RFID antenna adjusted, ADV values for Scale 2 rose to levels closer to those in Scale 1. In barn 2, automatic sorting was started towards the end of the 5th week. This 2-week difference in the length of acclimation period was a producer judgment based on his assessment of pig health and barn conditions. Similarly, pre-autosort

ADVs were less than 1 but increased sharply to about 2 visits per day by the 6th week when pen partitions were replaced and pigs had no other option but to go through the scale.

Problems regarding data capture can arise when the antennae attached to scales are not properly placed or adjusted to desired frequencies that could pick up signals from RFID tags. This appeared in the data set as a high proportion of weights without corresponding RFID identification. Although weights were registered in the scale each time a pig passes through, the pig's RFID numbers were not and were replaced with a series of zeroes, reflecting the presence of a large number of untagged pigs when all animals in the pen were known to be tagged. Absence of RFID numbers in the data downloaded might give an impression that these pigs have not gone through the scales at all. This problem could go unnoticed particularly if there was a large amount of data and trends were not obvious.

Several other possible causes for intermittent failure of tag reading were observed that could explain the fluctuations in the weekly ADV values after acclimation and before the first market. These include:

- (1) *The scale's limitation to store a maximum of 1200 visits.* When the number of visits through each scale exceeded 1200 visits, oldest data were written over and unless downloaded immediately, some data would be lost. The number of visits made by the affected pigs for the day could be reduced or deleted. This would appear in the data as gaps between two successive weight entries from a few to several hours. Frequent manual data download or attachment of an automatic download device could solve

the problem. In each download, new data were added in the database. Previously downloaded data were not repeated.

- (2) *Entry of two pigs on the scale at the same time.* This was observed when a second pig happened to get inside the scale before the pneumatic gates closed. Only the tag of the first pig was registered since the RFID antenna was positioned near the sort gate or the scale's exit. In few instances, the pig that was inside the scale did not immediately move out and stayed long enough until the scale gates were opened, allowing others standing at either opening to force their way through the scale without their tags being read.
- (3) *Entry through feed court's exit gates.* Another reason that was frequently observed was the ability of some pigs to force their way through the feed courts' exit gates by flipping the vertical steel bars that block entry through these gates with their snouts.
- (4) *Pigs remained in feed courts.* Some pigs that did not feel well during those particular days may have chosen to remain inside the feed court where they could access feed and water immediately. There was no impetus to leave the feed court and therefore cycle through the scale.

The observed causes of failure of tag reading that affected frequency of scale visits also had an impact on the number of daily records obtained so an average of the weekly number of records taken around each time point were considered to minimize the effect of zero visits. Illustration of the number of records obtained at each time point was done to present the possible effects on data when a study using autosort scales were conducted before automatic sorting was started and if the study were to end at the period when some tags have already

been lost (eg. close to market). In Table 3, Time 1 registered only a total of 2,126 observations or weight records for one-week before the autosort scales were started and pen partitions closed. Time 2 registered 7,810 observations which was after automatic sorting was started but RFID antenna in pen 2 was not properly picking up tag signals. Time 3 registered 11,063 observations after the RFID antenna was adjusted. The decrease in the number of observations to 5,761 in Time 4 was attributed to the increased number of tag lost during this period.

Extremely wide ranges in weight data of some pigs were observed (eg. from 47.76 to 139.49 lbs) and some of the recorded weights were suspected as inaccurate. These figures were probably products of double-occupancy and/or excessive pig movements inside the scales. Given fluctuating weights that would vary within a day or several days, future researchers employing this technology will need to specify the criteria for including or eliminating specific weights and data points. The issue of how to qualify outliers and inaccurate weights and remove them so that the quality of conclusions obtained would not be compromised must be addressed in the protocol and reporting of these trials.

To eliminate the negative effect of these figures on the data, the smallest weight recorded at each time point was chosen. This value was added to the average weight of every pig at the particular time point to set the maximum weight limit for inclusion of weights collected for each pig. Similarly, this value was subtracted from each pig's average weight to set the minimum limit for weight inclusion. Each of the pig's weights that was greater or smaller than their individual maximum and minimum weight limits were removed and the remaining

weights were averaged per pig. The value for the new 1SD for the whole population was obtained and used to set the maximum and minimum limits in weight inclusion for the removal of inaccurate weights, weights that still varied largely from the weights collected per pig at each time point. The number of observations decreased as these data entries were removed in the process but the descriptive statistics did not change much except at the first time point which corresponded to the pre-autosort phase. The process reported here was arbitrary, should be appropriately modified based on the objectives of a particular study, and reported transparently in publication.

Time 1 was the period when the scales were kept open and two or more small pigs would stay and sleep on the scales. Note that the maximum weight (140.81lbs) was equivalent to about twice the average weight (61.64 lbs), suggesting that there were at least two pigs on the scale. After being removed in step 2, the highest recorded weight was replaced by a still high value (139.05 lbs) equivalent to two pig weights. The reason why this weight remained after step 3 was because the pig had only one weight registered. Time 1 also had the most number of weight observations removed until step 3. Occurrence of wide weight ranges were less after Time 1 as reflected by the fewer observations removed until step 3. This implies that data were more consistent when collected at the time when the scales were set to autosort. Fluctuations in weight data during automatic sorting could be attributed to double-occupancy and excessive movements inside the scale. Excessive pig movements could precipitate scale breakdown. When this happens, the scale might not open and unless detected immediately, no data could be obtained for hours. Once detected, the scale could be set mechanically to keep its pneumatic entry and sort gates open until repaired so pigs could go through to feed.

Since the scale would open only to one side of the feed court, partition between feed pens should be removed to allow access to the other side and prevent crowding. The scale could still weigh pigs and read RFID tags but the problem would be on the accuracy of the records since there would be no control over the entry and exit of pigs as they pass through. Double-occupancy on the scale could produce extremely large weights. However, these figures were easier to spot than inaccurate weights that were several pounds smaller or higher (eg. 15-30 lbs) than other weight readings taken from the same pig in a few seconds, minutes, hours or even a day. The pig's reluctance to leave the scale could trigger the gates to open and close which might result to registration of inaccurate weights. It was also observed that pigs on the scale would produce excessive movements as they were pushed off by another each time they stayed on the scale long enough with the gates open. This would provide other pigs waiting at the scale openings opportunity to also enter the scale and in the process contribute whole or part of their weight to the first pig. Inaccurate weights were more difficult to detect in pigs that had no other weight data available within the day or week for comparison. When data only from certain dates were selected in monitoring weights, confusing records might be encountered and choosing the right weight is difficult.

Acknowledgments

This research was supported by funds from the Iowa Healthy Livestock Committee. The authors thank Joey Schon for providing the study animals and barn facilities.

References

1. Understanding key issues in radio frequency identification (RFID). Symbol Mobility Learning Center Web site. 2004. Available at: http://www.symbol.com/products/whitepapers/rfid_key_issues.html. Accessed November 12, 2005.
2. Granneman S. RFID chips are here. *Security Focus* [serial online]. 2003. Available at: <http://www.securityfocus.com/columnists/169> . Accessed on November 8, 2005.
3. General RFID information. RFID Journal Web site. Available at: <http://www.rfidjournal.com/faq/16/49>. Accessed on November 12, 2005.
4. Bitpipe Web site. Available at: <http://www.bitpipe.com/tlist/AIDC.html> Accessed November 8, 2005.
5. Webopedia Web site. Available at: <http://www.webopedia.com/TERM/R/RFID.html>. Accessed November 11, 2005.
6. Morrison R. Observations on automatic sorting. London Swine Conference. 2004:45. Available at: <http://www.londonswineconference.ca/proceedings/2004%20London%20Swine%20Conference%20Proceedings.pdf>. Accessed November 30, 2004.
7. Li N, Schinckel AP, Preckel PV, Richer BT. Using a stochastic model to evaluate swine production management with Paylean® IV: return of accurate sorting for marketing. Swine Research Report. Purdue University. 2003:40-47. Available at: <http://www.ansc.purdue.edu/swine/swineday/sday03/7.pdf> . Accessed December 30, 2005.
8. Gunderson K. Benefits of Auto-Sort Technology Outlined. *Midwest Messenger* [serial online]. April 4, 2005. Available at: http://www.midwestmessenger.com/articles/2005/04/06/around_the_web/story3.txt. Accessed January 13, 2006.

9. Automatic sorter. *Pig International*. 2005;35(10):28.
10. Survey scales. Osborne Industries, Inc. Web site. Available at: http://www.osborne-ind.com/lvstcksub/Scales/weight_watcher/survey_scales.htm. Accessed November 30, 2004.
11. Avoid Marketing Mediocrity. *Progressive Pork* [serial online]. Winter 2004. Available at: http://www.farmweld.com/progressivepork/winter_2004/marketing.html. Accessed January 16, 2006.
12. Vansickle J. Ten keys to automatic sorting. *National Hog Farmer* [serial online]. November 15, 2004. Available at: http://nationalhogfarmer.com/mag/farming_ten_keys_automatic/index.html. Accessed November 30, 2004.

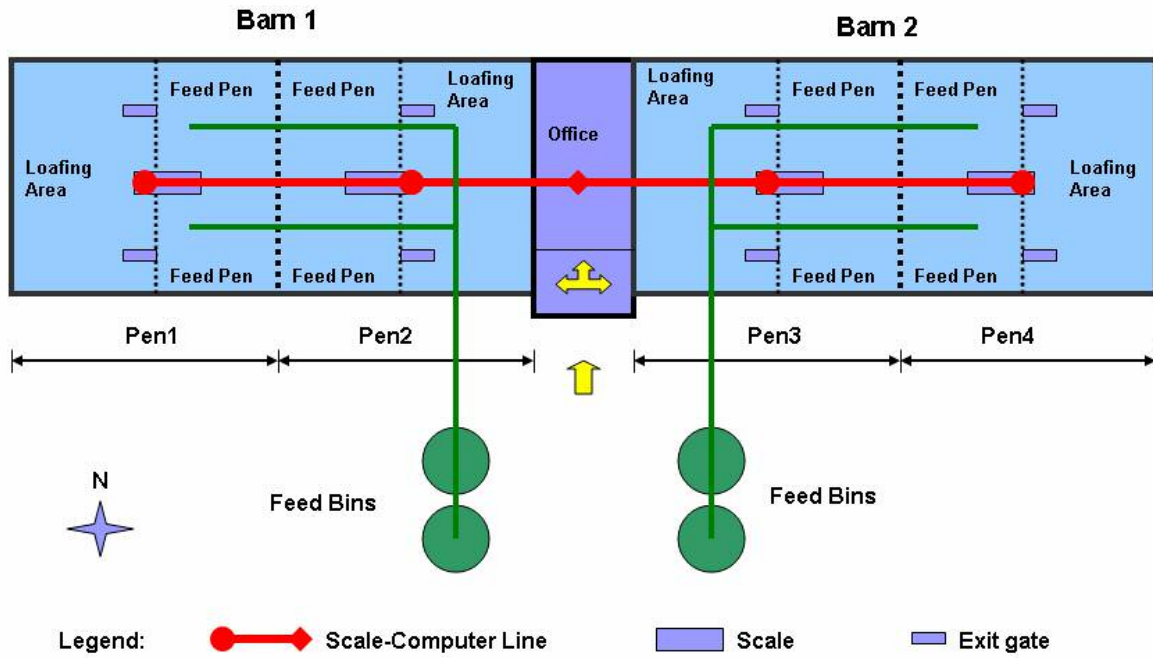

Figure 1. Farm lay-out.

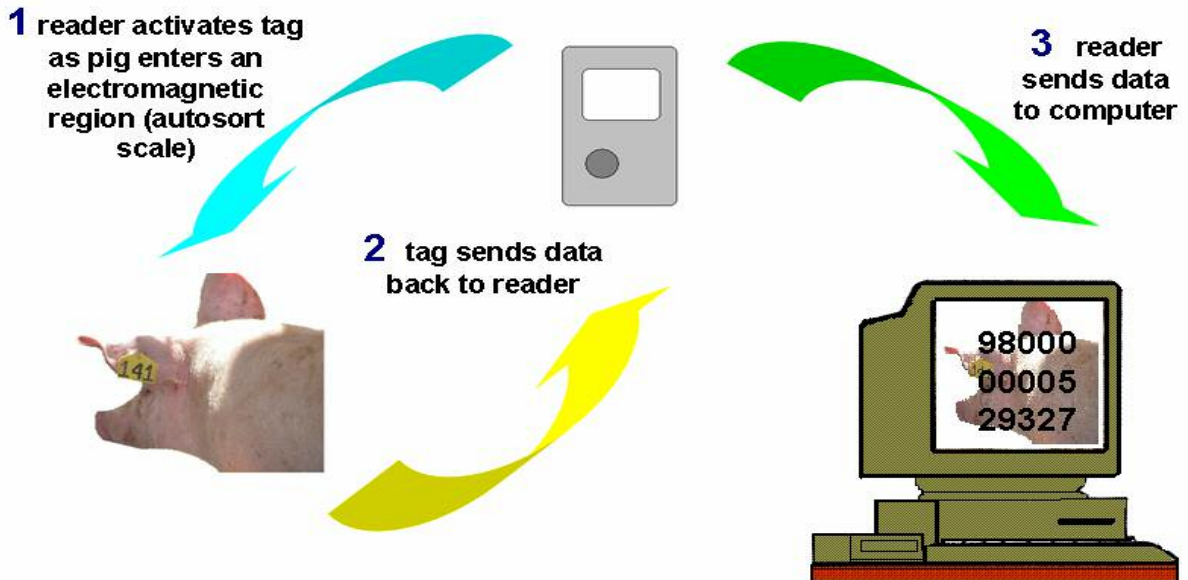

Figure 2. An illustration of the RFID mechanism.

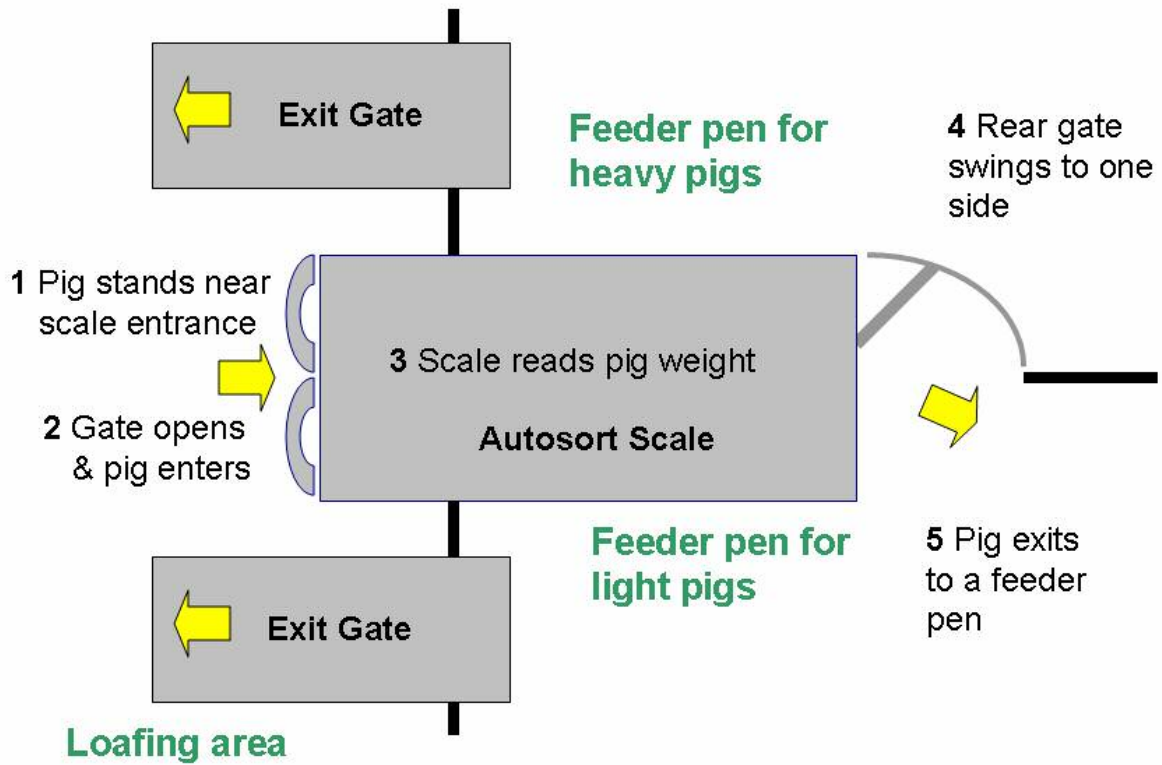

Figure 3. An illustration of the automatic sorting mechanism.

Table 1. Distribution of RFID tags in the four pens post-tagging to first market.

N Tags	Barn 1		Barn 2	
	Pen 1	Pen 2	Pen 3	Pen 4
Lost until 1st market	295	29	226	392
Reached 1st market	122	367	193	58
Mortalities until 1st market	82	71	48	66
No data	2	4	3	4
Untagged Pigs	4	2	72	16
Total pen population	505	473	542	536
Actual Pen Population*				
10 wks	429	386	464	474
12 wks	425	386	457	465
At 1st market	422	383	452	461

*Pigs removed due to mortality and morbidity were excluded.

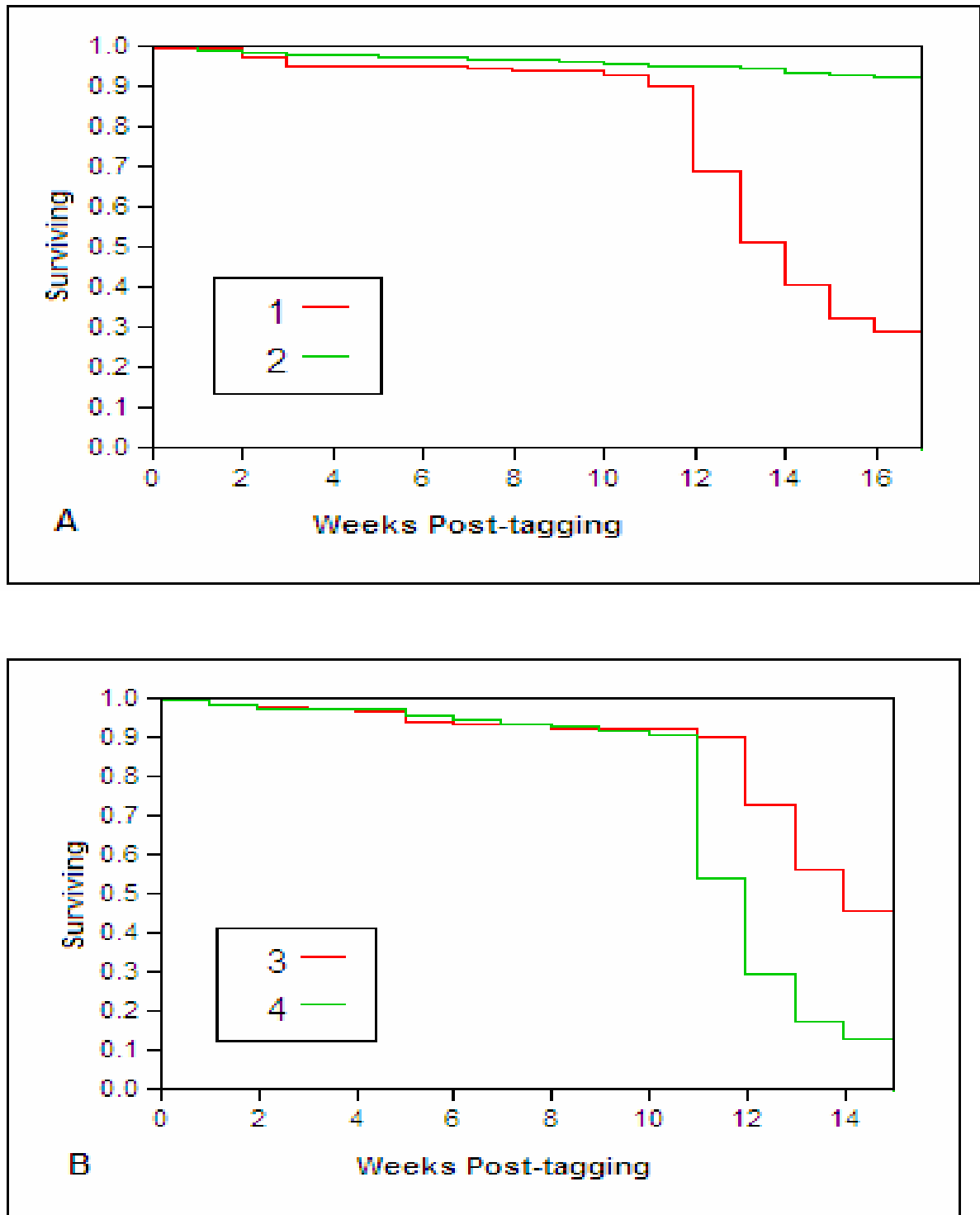
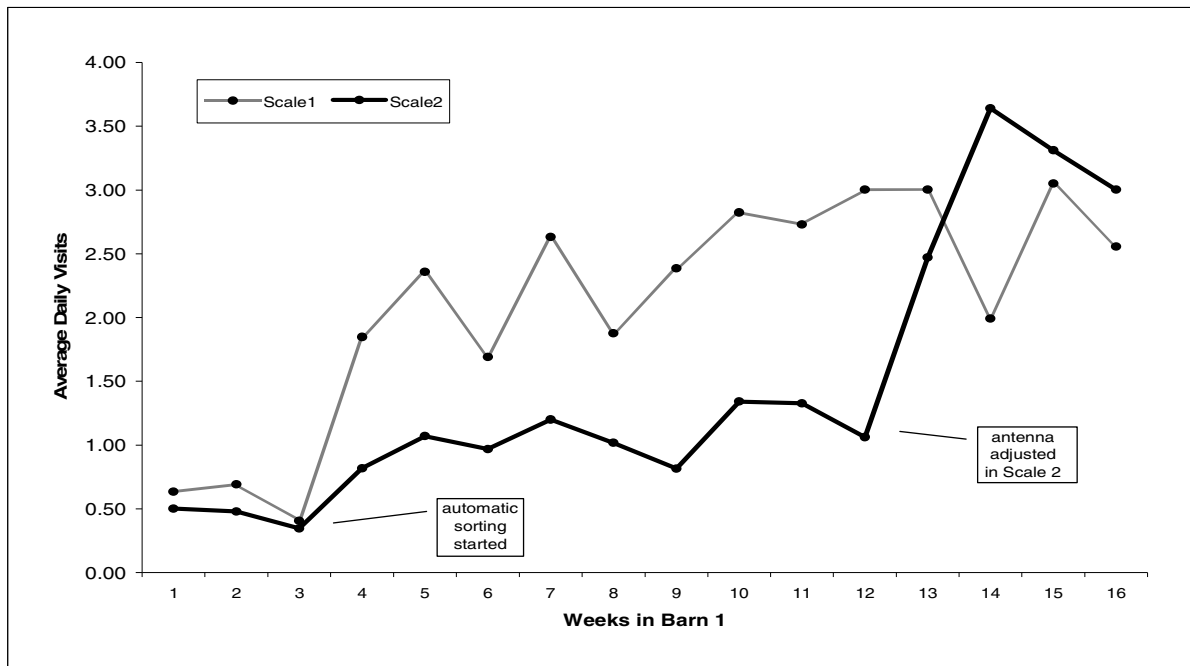

Figure 4. Survival curves of tags from barn 1 (A) and barn 2 (B).

Table 2. Estimated number of scale visits per pen by pigs that made it through the whole trial to market and were not placed in the sickpen.

	Pen 1	Pen 2	Pen 3	Pen 4
Most visits by any one pig on any one day in the pen	22	17	16	16
Least visits by same pig in any day (that they were alive and not in sick pen)	0	0	0	0
ADV per day for whole pen	2.75	2.43	2.85	2.78
Highest ADV by any one pig	7.62	5.59	5.74	5.42
Lowest ADV by any one pig	0	0	0	0

Note: Each weight recorded by the scale was identified as one trip through the scale.



A

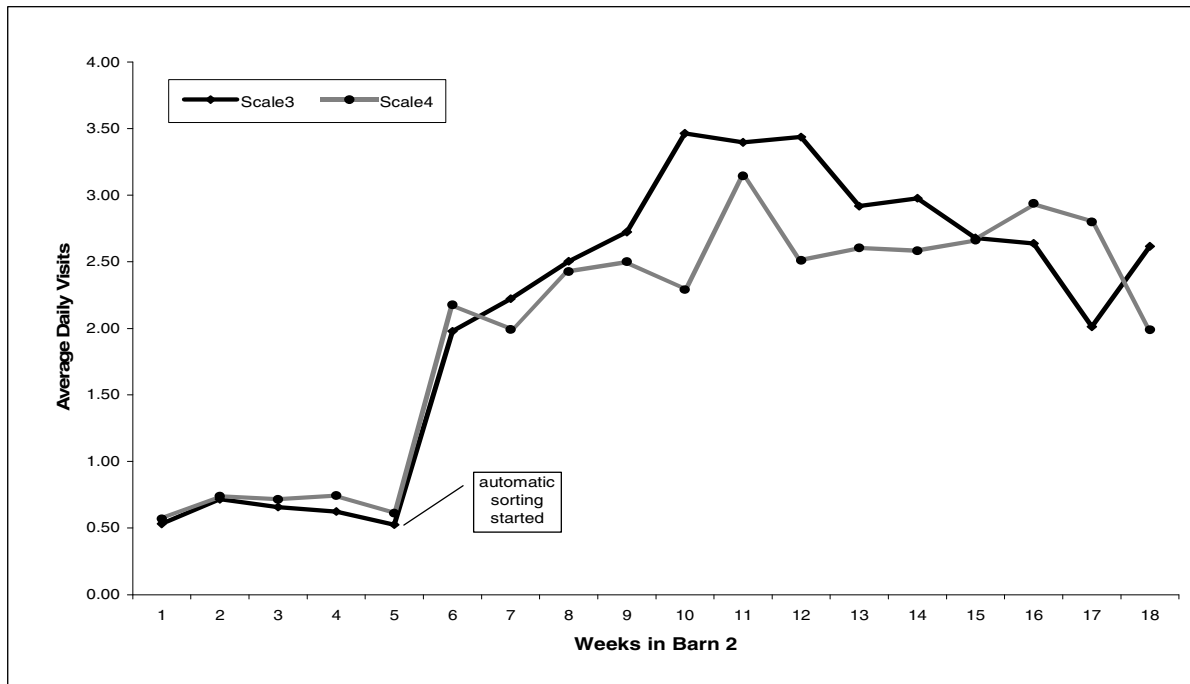

B

Figure 5. Trend of the estimated average daily visits (ADV) per pen in barn 1 (A) and barn 2 (B) computed weekly showing the differences in ADVs in all pens before and after automatic sorting was started and, in barn 1, when the RFID antenna was not properly placed.

Table 3. Five-number summaries, means and standard deviations of one-week weight data of all pigs in barn 1 obtained from each of the four time points.

	Step 1*	Step 2*	Step 3*
<u>Time1</u>			
Maximum	140.81	139.05	139.05
75% Percentile	72.17	69.97	66.89
Median	59.19	58.53	58.09
25% Percentile	47.96	48.40	49.28
Minimum	25.96	25.96	27.72
Mean	61.64	59.77	58.47
Standard Deviation	17.93	14.75	12.39
N Observations	2126	1919	1511
<u>Time2</u>			
Maximum	232.34	167.66	167.22
75% Percentile	112.65	112.21	112.21
Median	99.01	98.57	99.01
25% Percentile	86.69	86.69	86.69
Minimum	42.24	42.24	42.24
Mean	99.67	98.91	98.89
Standard Deviation	20.92	19.38	19.26
N Observations	7810	7725	7619
<u>Time3</u>			
Maximum	367.88	248.18	248.18
75% Percentile	183.00	182.62	182.62
Median	165.45	165.46	165.46
25% Percentile	106.93	147.85	147.85
Minimum	64.25	64.25	64.25
Mean	164.83	164.74	164.69
Standard Deviation	26.78	26.30	26.26
N Observations	11063	11032	1909
<u>Time4</u>			
Maximum	362.60	283.80	283.80
75% Percentile	226.60	226.60	226.60
Median	210.80	210.80	210.80
25% Percentile	190.50	190.50	190.50
Minimum	70.80	84.90	84.90
Mean	207.21	207.15	207.04
Standard Deviation	28.24	27.76	27.59
N Observations	5761	5741	5652

* Step 1 from raw data; Step 2 formula: pig weights < minimum weight limits per pig [average weight per pig – smallest population weight] and > maximum weight limits per pig [average weight per pig + smallest population weight] were excluded; Step 3 formula: using computed average weight per pig from step 2, pig weights < minimum weight limits per pig [average weight per pig – 1 SD of step 2] and > maximum weight limits per pig [average weight per pig + 1 SD of step 2] were excluded.

CHAPTER 4. USE OF RFID TAGS AND AUTOSORT SCALES IN MONITORING GROWTH OF PRRS-INFECTED FINISHING PIGS

A short communication paper to be submitted to the Veterinary Record

Ruby Destajo, Locke Karriker, and Annette O'Connor

Department of Veterinary Diagnostic and Production Animal Medicine, College of
Veterinary Medicine, Iowa State University, Ames, Iowa, USA

Porcine Reproductive and Respiratory Syndrome (PRRS) is a disease that significantly impacts swine performance targets and profitability. To monitor the effect of PRRS virus infection on the growth of finishing pigs under field conditions, a cohort study was conducted on finishers raised in a commercial finishing barn in central Iowa equipped with electronic scales that automatically sort pigs and whose functionality was enhanced by an integrated radio frequency identification (RFID) system. Autosort scales enabled real-time monitoring of pig weights. This technology has been used in swine farms to reduce sort loss, promote early market of heavy pigs, labor savings and improved animal welfare (Morrison 2004, Vansickle 2004). The integrated RFID technology allowed electronic identification of specific pigs as they pass through the scale. RFID tags attached to the ears of individual animals transmitted 15-digit serial numbers to RFID readers placed on scales in a process similar to that described by Clayton (2006).

Fifty finishers from a large pen of 505 pigs and another 50 from a second pen of 473 pigs were entered into the study. Every fifth pig from each pen was chosen, alternating barrows and gilts. Selection and ear tagging with commercial ear tags for visual identification and RFID transponders (Osborne e-DISC™, FDX-B ISO 11784/5) for electronic identification were done a week after transfer from the nursery. Prior to tagging, RFID tags were attached to the numbered commercial ear tags and their corresponding 15-digit serial numbers were verified using a handheld reader (HOTRACO MicroID Pocket Reader 001, Osborne Industries, Inc.).

The pigs were raised in a 1,000-head capacity barn with two large 500-head capacity pens. Each pen was further sub-divided into one large loafing area and two smaller food courts with a complete set of automatic sorting scales (Osborne Industries, Inc., Osborne, Kansas) integrated with an RFID system and connected to the computer in an adjacent room serving as an office. Data were downloaded daily as the figures would be stored in the scale's controller only up to midnight of the following day.

Blood collection was done three times at monthly intervals. Samples were collected from the jugular vein or anterior vena cava using single-use serum-separating tubes (BD Vacutainer™, Franklin Lakes, New Jersey). Sera were stored at -80°C and submitted to the Iowa State University Veterinary Diagnostic Laboratory to determine PRRS status. Sera were tested with (a) enzyme-linked immunosorbent assay or ELISA (PRRS virus antibody test kit; IDEXX Laboratories, Inc., Westbrook, Mass.) where the ratio of net optical density of test sample to net optical density of positive control (S/P) ≥ 0.4 indicate positive result for

antibody against PRRSV, and (b) reverse transcriptase – polymerase chain reaction (RT-PCR) to detect PRRS virus RNA. The specificity and sensitivity of the RT-PCR test used were 99.5% and 98.5% respectively (Karen Harmon, personal communication, June 12, 2006). All methods used were approved by the ISU Animal Care and Use Committee. One-week weight data for each pig were taken during acclimation (Time 1) and automatic sorting (Times 2, 3 and 4) at monthly intervals. Times 1, 2 and 3 correspond to the three bleeding periods while Time 4 was the time the first marketable pigs were sent to slaughter. Individual pig weights from 3 days before to 3 days after each bleeding date were obtained from the database containing all recorded pig weights throughout the rearing period. Weight record for Time 4 was the average of the weights collected on the day of the first market and data for the 3 days prior.

During the 3-week acclimation period, pigs were allowed to walk around the pens to familiarize themselves with the location of the feeders and waterers. The gates of electronic scales were left open, allowing pigs to go through. Although their weights were measured by the scale, there was no control in the number of head entering the scale at the same time. By the end of the acclimation period, the scales were set, and pigs were trained to use the scales for 2 to 3 days. Entry to and exit from the electronic scales were already regulated.

Individual pig data obtained from the database were examined for consistency. Outliers and suspected inaccurate weights for each pig were removed using defined minimum and maximum weight limits based on individual average weights per time point.

(1) *Removal of outliers:* Pig mean weights at each time point were obtained. The smallest weight in the population at the same period was identified and added to the mean weight of each pig to get the maximum weight and subtracted from the mean weight to get the minimum weight for each pig. Individual pig weights lighter than the minimum cut-off and heavier than the maximum cut-off weights were excluded. Remaining weight data for each pig were then averaged and the population standard deviation (1SD) was determined for use in setting cut-off weights to eliminate inaccurate weights.

(2) *Removal of inaccurate weights:* Mean weight per pig \pm 1 SD to get the maximum and minimum cut-off weights respectively, in a process similar to removal of outliers. The remaining weights per pig were averaged and designated as the final weight record for each pig for that time point.

Exploratory analyses of weight data were initially done in JMP (SAS Institute Inc., Cary, North Carolina). Responses (weights) over time were analyzed as a repeated measure using PROC MIXED (SAS Institute Inc., Cary, North Carolina) with the pig as the experimental unit.

Out of the 100 head initial sample, only weight data from 75 pigs were considered in the analysis. Sixteen mortalities occurred during the monitoring period while nine did not have weight data or lost their tags at subsequent bleeding periods and were not bled. Eleven pigs died of pneumonia or pleuropneumonia while five died of gastrointestinal problems related to chronic gastric ulcer (2 pigs), hemorrhagic bowel syndrome or torsion (2 pigs), and colitis (1 pig). Death causes were based on predominant necropsy lesions.

Virology results of the sample population indicated an ongoing PRRS infection of the herd by the time they were transferred to the finishing barn. Fifty-two out of 75 pigs were initially PRRS virus positive by RT-PCR (Table 1). This fraction decreased to 14 pigs four weeks later and to zero in another four weeks. In contrast, the PRRS ELISA test gave only one positive result by the time of transfer with an S/P ratio of 0.463. After four weeks, only 22 pigs remained negative (S/P ratio below 0.4). After another four weeks, 26 pigs were negative. Median S/P ratios in the last two time points (0.717 and 0.582) were very much higher than the first time point (0.044). The decreasing trend in the presence of PRRS virus in the blood and the increasing amount of antibodies suggests exposure to PRRS virus prior to the transfer of the pigs to the finishing barn since antibodies to PRRS virus infection are detectable at 14 days post-infection by ELISA (Ferrin and others, 2004). This was consistent with the reported higher than normal mortality (11%) of this production group while in the nursery.

The pigs were assigned to one of the eight groups retrospectively based on the combined virology results for ELISA and RT-PCR tests (Table 2). A positive result for either or both tests at each bleeding period was indicated by a “p” and negative results for both tests was an “n”. More pigs were positive (52 head) than negative (23 head) in the first bleed period.

Among the negatives, two out of 75 were found negative (nnn) throughout, four were positive on the third (nnp), six turned positive in the second and became negative in the third (npn), and eleven became positive in the succeeding bleed periods (npp). Among the 52 pigs that were positive in the first bleed period, six became negative in the next two months (pnn), another six became negative a month after and became positive in the third month (pnp),

twelve remained positive in the second month and turned negative on the third (ppn), and twenty-eight were positive in the three bleed periods (ppp).

Repeated measurements of weights analyzed using SAS proc mixed showed a significant interaction between groups and time ($P < 0.0140$) suggesting significant differences in mean weights between groups over time (Table 3). This could be influenced in part by group size as the assignment of pigs to which group was dependent on virology results. The smallest group (2 pigs), for example, was the group that was negative while the largest group (28 pigs) was positive in all bleed periods. The initial weights of these pigs at the start of the study were not uniform. However, weight data in succeeding time points showed variation in weight trends per group. The two most contrasting groups with respect to PRRS status were PRRS-negative and PRRS-positive at all time points. Both were of about the same mean weight in Time 1 (nnn=74.89 lbs, ppp=70.48 lbs) but the PRRS-negative group became heavier by Time 4 (nnn=224.38 lbs > ppp=207.56 lbs).

While this trial design limited significant conclusions regarding the impact of PRRS status on weight gain, it provides a contrast for paradigms about the rate of PRRS spread and antibody response in contiguous groups of pigs which is normally characterized as rapid by anecdotal field observations. Among these 75 pigs, 42 were positive at the first sampling, 17 more were positive 4 weeks later, 4 additional pigs were positive 8 weeks later, and 2 pigs were never positive by PCR or ELISA testing. Given diagnostic assessment in the nursery phase that verified PRRS virus, these samples represent the minimum amount of time that viral circulation occurred in the group.

Virology results from the sample population were consistent with the severe clinical respiratory signs exhibited by a number of pigs particularly in the first two months of the grow-finish phase. Majority of those necropsied had lung lesions characteristic of mixed respiratory infection or porcine respiratory disease complex. Bacterial isolates from lung tissues include *Pasteurella multocida*, *Streptococcus suis*, *Bordetella bronchiseptica* and *Arcanobacterium pyogenes*. The degree to which PRRS virus infection can influence production depends in most cases, on the existence of other respiratory pathogens, by virtue of their ability to synergistically produce more severe respiratory diseases. It has been known that pneumonia can compromise feed efficiency and growth performance in swine herd (Straw and others, 1989). One of the major effects of respiratory diseases on growth performance is reflected in the average daily gain. Their impact in the herd is often uneven, some pigs being greatly affected in their ADG than others (Deen, 1996), leading to wide variation in weights. This increasing amount of variation in swine herd makes animal movement in the production system (pig flow) more difficult to manage (Yeske, 2000). Respiratory diseases can also predispose animals to secondary conditions like gastro-esophageal ulcers and enteric diseases (Deen, 1996).

Although the results of the statistical analyses obtained in the present study was limited by its dependence on the evaluation of weight data obtained using RFID technology-enhanced autosort scales, the fact remains that PRRS virus infection could influence production through its synergistic effect with other respiratory pathogens. The severity of its impact on the animal depends on the ability of each individual to combat the infection.

Acknowledgment

This research was supported by funds from the Iowa Healthy Livestock Committee. The author wishes to thank Joey Schon for providing the study animals and barn facilities.

References

- Clayton G. (2006) High-tech feed packages. *Feed International*. 27(7), 20-21.
- Deen J. (1996) What is the effect of respiratory disease on productivity? Proceedings in North Carolina Healthy Hogs Seminar. North Carolina Swine Veterinary Group. Available at: http://mark.asci.ncsu.edu/HealthyHogs/book1996/book96_16.htm. Accessed February 25, 2006.
- Ferrin, N.H., Fang, Y., Johnson, C.R., Murtaugh, M.P., Polson, D.D., Torremorrell, M., Gramer, M.L., & Nelson, E.A. (2004) Validation of a Blocking Enzyme-Linked Immunosorbent Assay for Detection of Antibodies against Porcine Reproductive and Respiratory Syndrome Virus. *Clinical Diagnostic Laboratory Immunology*. 11(3), 503-514.
- Morrison, R. (2004) Observations on automatic sorting. London Swine Conference. April 1-2, 2004. p45. Available at: <http://www.londonswineconference.ca/proceedings/2004%20London%20Swine%20Conference%20Proceedings.pdf>. Accessed November 30, 2004.

- Straw, B.E., Tuovinen, V.K., & Bigras-Poulin, M. (1989) Estimation of the cost of pneumonia in swine herds. *Journal of American Veterinary Medicine Association*. 195,1702-1706.
- Vansickle, J. (2004) Ten keys to automatic sorting. *National Hog Farmer*.
http://nationalhogfarmer.com/mag/farming_ten_keys_automatic/index.html. Accessed November 30, 2004.
- Yeske P. (2000) Predicting and managing pig flow. *Proceedings in American Association of Swine Practitioners*. Pp. 293-297.

Table 1. Descriptive statistics on S/P ratios, ELISA and RT-PCR results from 75 pigs.

	Time 1	Time 2	Time 3
<u>Descriptive statistics on S/P ratios</u>			
Maximum	0.463	3.094	2.307
75% Percentile	0.093	1.039	1.141
Median	0.044	0.717	0.582
25% Percentile	0.013	0.359	0.308
Minimum	0.000	0.018	0.052
Mean	0.065	0.812	0.742
SD	0.080	0.627	0.571
SE	0.009	0.072	0.066
N	75	75	75
<u>S/P ratios classification</u>			
< 0.40	74	22	26
0.40 – 0.99	1	32	28
> 1.00	0	21	21
<u>ELISA results</u>			
Positive	1	53	49
Negative	74	22	26
<u>RT-PCR results</u>			
Positive	52	14	0
Negative	23	61	75

Table 2. Least square means (+/- standard errors) of the groups of pigs at each time point.

Group* [No. pigs]	Time 1	Time 2	Time 3	Time 4
nnn [2]	74.89 (18.46)	127.38 (17.09)	197.28 (14.79)	224.38 (14.79)
nnp [4]	41.81 (12.08)	100.28 (10.46)	165.59 (10.46)	205.74 (10.46)
npn [6]	47.24 (13.96)	118.02 (8.54)	181.71 (8.71)	221.76 (8.54)
npp [11]	63.21 (7.69)	107.55 (6.70)	171.82 (6.37)	214.90 (6.41)
pnn [6]	51.57 (11.03)	105.67 (8.54)	166.00 (8.54)	217.78 (9.23)
pnp [6]	57.23 (9.27)	105.49 (8.84)	171.43 (9.02)	222.46 (11.28)
ppn [12]	59.73 (7.85)	103.71 (6.13)	168.61 (6.10)	218.82 (7.01)
ppp [28]	70.48 (4.44)	98.74 (4.00)	160.45 (4.03)	207.56 (4.29)

* Grouping based on ELISA and PCR test results. Pigs negative on both tests in each of the three time points were regarded as negative (n) and those positive on either test were positive (p). Each letter represented the PRRS status in the three bleeding periods.

Table 3. Results of the repeated measures analysis of group weights in SAS proc mixed (AR1 covariant structure used) showing the type 3 test of fixed effects.

Effect	Numerator DF	Denominator DF	F Value	Pr > F
Groups	7	69.2	0.59	0.7599
Time	3	136	650.81	<.0001
Groups*Time	21	130	1.93	0.0140

Groups = nnn, nnp, npn, npp, pnn, pnp, ppn, ppp; AR1 = autoregressive 1 covariant structure; DF = degrees of freedom

CHAPTER 4. GENERAL CONCLUSIONS

General Discussion

Retention of tags appears to be affected by pen density and length of time pigs stayed in the barn. In the study, there appeared to be a 10-week window for tags to remain attached to the ears as long as tagging was done before or shortly after transfer to the finishing barn. Sharp increases in tag loss after this 10-week period could be attributed to increased ability of pigs to remove tags because of their size and/or constant chewing of ear tags ultimately caused these to fall off. Tags were also more likely to lose earlier in pens with more pigs than in pens with fewer pigs. These may be a major consideration for researchers who plan to use RFID tags in monitoring pig weights in a commercial barn under field conditions to avoid significant loss of data especially if they prefer to tag only a small sample of the population.

One limitation to relying on pigs to weigh themselves was that they might not provide data at consistent time intervals. Equipment or tag failures can lead to missing information that might not be discovered and corrected until after the time period in question. When establishing the duration of weight monitoring utilizing these systems, the dates for the start weight (whether during or after acclimatization) and the end weight (drop-outs due to tag losses or mortality) should be carefully taken into account. Significant loss of information could happen at both ends. Constant quality control monitoring of data gathered is necessary. The system is complex and subject to failures that do not create obvious changes

in the external operation of the scale system. System breakdown might occur anytime which could lead to lost or altered data.

Weights obtained through this system could be used to monitor pig weights. The challenge would lie on how to evaluate the information obtained and how to establish quality control limits to exclude errant data points. This would depend on the amount of data gathered and the duration of the study. A system should be defined to determine errant weight values that might be registered to avoid confusion.

Utilizing the AST-RFID technologies, data from the PRRS study shows that PRRS virus can negatively affect growth performance of the finishing herd. This could occur through lowering of average daily gain and increasing weight variability in the herd. Results imply pigs infected at some point in the production could recover in terms of weight gain but those that were infected for longer periods could more likely end up lighter in terms of weight gain.

ACKNOWLEDGMENTS

The author wishes to thank the following persons for making invaluable contributions to the making of this thesis one way or another:

To Dr. Locke A. Karriker for his guidance, patience, and encouragement throughout this project; Dr. Jeffery J. Zimmerman and Dr. Annette M. O'Connor for the suggestions and advice on the content of this manuscript.

To the Summer 2005 Swine Team (a.k.a. Karriker team) for their invaluable help in data gathering and keeping up with the pigs: Lori Layman (leader), Ernie Owens, Stacy Lord, Samantha Frankovich, Travis Hargens, Ryan Shaefer, and Abby Patterson; to the other vet. med. students and animal science graduate students, especially Nick Berry and his team, who at one time or another helped in the bleeding and restraining of pigs.

To Francis Landiza and Christopher Camacho, for their help in converting Paradox files to Microsoft® Access files expediting the process of data gathering.

To the J. William Fulbright Foreign Scholarship Board, the US Department of State, the Philippine Department of Agriculture, and the Philippine-American Educational Foundation for the support, financial or otherwise, as a student grantee. The Fulbright experience has entirely been very rewarding.