

2015

# Gametophytic cross-incompatibility in maize: resequencing the Ga1 locus

Marianne Lynn Emery  
*Iowa State University*

Follow this and additional works at: <https://lib.dr.iastate.edu/etd>

 Part of the [Agricultural Science Commons](#), [Agriculture Commons](#), [Agronomy and Crop Sciences Commons](#), and the [Genetics Commons](#)

---

## Recommended Citation

Emery, Marianne Lynn, "Gametophytic cross-incompatibility in maize: resequencing the Ga1 locus" (2015). *Graduate Theses and Dissertations*. 14651.  
<https://lib.dr.iastate.edu/etd/14651>

This Thesis is brought to you for free and open access by the Iowa State University Capstones, Theses and Dissertations at Iowa State University Digital Repository. It has been accepted for inclusion in Graduate Theses and Dissertations by an authorized administrator of Iowa State University Digital Repository. For more information, please contact [digirep@iastate.edu](mailto:digirep@iastate.edu).

**Gametophytic cross-incompatibility in maize: Resequencing the *Gal* locus**

by

**Marianne Lynn Emery**

A thesis submitted to the graduate faculty  
in partial fulfillment of the requirements for the degree of

MASTER OF SCIENCE

Major: Plant Breeding

Program of Study Committee:  
M. Paul Scott, Co-Major Professor  
Thomas Lubberstedt, Co-Major Professor  
Michael Muszynski

Iowa State University

Ames, Iowa

2015

Copyright © Marianne Lynn Emery, 2015. All rights reserved.

For my parents, who instilled a work ethic and tenacious nature in their daughters that bound them for success



De novo assembly by BAC.....	36
Conclusions.....	56
Significance.....	57
Recommendations for Future Research.....	58
References.....	60
<b>CHAPTER THREE: ENCYCLOPEDIA OF FOOD GRAINS:</b>	
<b>MAIZE CHAPTER.....</b>	<b>64</b>
Abstract.....	64
Introduction.....	64
Maize Reproduction.....	65
Maize Kernel Composition.....	66
Starch.....	67
Oil.....	68
Protein.....	69
Maize in Food.....	71
Maize processing.....	71
Maize in Science.....	73
Maize Breeding, Genetics, and Biotechnology.....	74
Maize cultivar types.....	74
Hybrid maize breeding.....	75
Maize biotechnology.....	76
References.....	79
<b>APPENDIX: ADDITIONAL ALLIGNMENT INFORMATION.....</b>	<b>84</b>

## LIST OF FIGURES

		<b>Page</b>
Figure 2.1	BAC assembly pipeline.....	25
Figure 2.2	Predicted gene model in the region of interest for B73 v3 reference genome.....	27
Figure 2.3	BAC 2 reads mapped to entire B73 genome.....	30
Figure 2.4	BAC read sequence distribution over the B73 region of interest.....	32
Figure 2.5	BAC reads mapped to B73 region of interest .....	35
Figure 2.6	Contig length distribution of assembled contigs by BAC.....	38
Figure 2.7	Hypothesized arrangement of BAC sequences and presence of B73 predicted genes.....	44
Figure 2.8	Contig alignments to B73 predicted genes in region of interest.....	47
Figure 3.1	A phylogeny of diploid grass species.....	65
Figure 3.2	A mature maize kernel, showing component parts.....	67
Figure 3.3	U.S. maize grading scale.....	70
Figure 3.4	Maize food processing determines maize as food ingredient.....	71
Figure 3.5	Types of hybrids grown commercially in North America.....	73
Figure 3.6	Percentage of all maize grown in the United States that is genetically engineered (GE).....	75

## LIST OF TABLES

		<b>Page</b>
Table 2.1	Markers used to identify BACs.....	22
Table 2.2	Position, strand, and model type of predicted genes in the B73 reference genome.....	27
Table 2.3	BAC2 BWA alignment to the B73 genome vs region of interest.....	31
Table 2.4	Summary of comparative genome assembly: Mapped reads.....	34
Table 2.5	Summary of comparative genome assembly: Unmapped reads.....	34
Table 2.6	Results from individual de novo assemblies of BAC files before and after contamination removal.....	38
Table 2.7	Parameter optimization for de novo assembly.....	40
Table 2.8	Read coverage and repeat classification.....	41
Table 2.9	Genes from B73 reference genome present in BAC contigs determined by BWA alignment.....	42
Table 2.10	Polymorphisms between B73 and BAC de novo assembled contigs.....	48
Table 2.11	Gene prediction of BAC 2 assembled contigs 5 kb and longer.....	49
Table 2.12	BAC 2 contigs 5 kb and longer blasted to NCBI database.....	52

## **ACKNOWLEDGEMENTS**

Special thanks are extended to Nathan Weeks, Ethy Cannon, and Michelle Graham for their bioinformatics expertise in various aspects of the project.



**ABSTRACT**

Maize is an important staple crop for many countries. Culture dictates maize use, processing, and incorporation into foods. The crop has a rich history of domestication and improvement. With its relative ease of genetic manipulation, maize is considered a model crop for plant genetic experimentation. Recent biotechnological advances, as well as the completed B73 reference genome sequence, have expedited maize improvement. One such profound advance that has greatly increased profitability of maize is the use of transgenes. Despite the many benefits, transgenic plants are problematic when they contaminate transgene-free maize. Maintaining the purity of transgene-free maize is crucial, but often difficult when in close proximity to transgenic fields. Past literature suggests the use of the *Gal* gametophytic cross-incompatibility system to control pollen flow and minimize contamination of transgene-free maize. Yet, information about how the gametophytic cross-incompatibility system functions at the molecular level is still lacking. Our research sought to assemble BACs containing the *Gal-m* locus to better understand sequence variation with the B73 reference genome that may be causative of the male function in the *Gal* gametophytic cross-incompatibility system.

## CHAPTER ONE: INTRODUCTION

### Fertilization in Maize

Maize is a monoecious plant, possessing separate male and female reproductive organs on the same plant. Both organ types produce gametes, or haploid sex cells. Maize plants possess one male reproductive organ, referred to as the tassel. It is situated at the very tip of the main stem. One tassel can produce up to one billion pollen grains. These pollen grains are the male gametes. In contrast, several female reproductive organs can be present on one maize plant; the female reproductive organs are commonly known as ears. The female gametophyte, the embryo sac, is located within the ears. The ears are positioned at one or more nodes down the length of the main stem and are connected via a sheath. Fertilization occurs when gametes fuse to create a zygote; the maize fertilization process can be outlined in five main steps: (1) pollen hydration, (2) pollen tube germination and penetration of the stigma, (3) pollen tube growth in the transmitting tract and entering the embryo sac, (4) pollen tube exiting the transmitting tract, and (5) bursting of pollen tube which releases sperm nuclei and results in fertilization of the egg cell and two polar nuclei (Heslop-Harrison, 1982; Dresselhaus & Franklin-Tong, 2013; Johnson and Preuss, 2002). Mature pollen becomes dehydrated on the tassel and is dehisced where upon it travels on the wind until it lands on silks of the same (self-pollination) or different (cross-pollination) maize plants. Via osmosis, the silks quickly hydrate the pollen grain. Once hydrated, the pollen grain produces a pollen tube that enters the transmitting tract of the silk. In the event of a successful maize fertilization, the pollen tube continues to grow down the length of the silk in oscillating bursts and pulses until it reaches the ovary (Heslop-Harrison, 1987). Here, the tip of the

pollen tube bursts releasing two sperm nuclei. One sperm cell fertilizes the egg to produce the diploid zygote while the other sperm cell fuses with two polar nuclei to develop the triploid endosperm. This process is referred to as double fertilization.

Pollen-stigma interactions in pollen tube growth are not clearly understood. Pollen tube germination is recorded at growth rates close to one centimeter (cm) per hour, commencing five minutes after the pollen grain is deposited on the silk (Barnabas & Fridvalszky, 1984; Mascarenhas, 1993). Maize pollen tubes have been reported to grow to over 30 cm in length (Lu et al, 2014). Pollen tube growth is from the tip of the tube; the tip region is known to have intense secretory activity that is highly sensitive to  $\text{Ca}^{2+}$  gradients (Derksen et al, 1995; Feijo et al, 1995; Giampiero et al, 199; Steer and Steer, 1989). Cytoplasmic streaming and rearrangement of vesicles, membranes, and other organelles at the tip of the pollen tube are essential for germination and growth (Franklin-Tong, 1999; Heslop-Harrison & Heslop-Harrison, 1990; Heslop-Harrison & Heslop-Harrison, 1991; Mascarenhas, 1993; Pierson et al, 1990).

Despite highly optimized germination media, pollen tubes in vitro reach only 30-40% of their comparative in vivo lengths (Read et al, 1993). It appears that the silk plays a crucial role in pollen tube germination and growth. Research suggests that proteins encapsulating the pollen, waxes, and certain lipids may assist in initiating signaling required for both adhesion and germination of the pollen tube (Franklin-Tong, 1999). Despite experimental observations of pollen-stigma interactions, a complete understanding of the requirements and mechanisms of a germinating pollen tube have yet to be clearly defined.

### **Gametophytic Incompatibility Systems in Maize**

Gametophytic incompatibility was first observed by Correns in 1902. In a breeding experiment with White Rice Popcorn and a *sugary1* (*su1*) mutant, Correns observed distorted F<sub>2</sub> ratios for the sugary-starchy phenotype. Later, while researching the white maize phenotype, Demerec (1929) noted that he could only set seed with popcorn lines when they were used as a female in the cross. Demerec demonstrated that while the popcorn genotype was self-fertile, it was not fertile to non-popcorn pollen even in the absence of any competitive pollen. Demerec concluded the selective fertilizations were a result of a dominant factor linked to the *sugary1* (*su1*) locus. Emerson (1934) later noted that the crosses in White Rice Popcorn were not controlled by the *su1* locus, but by an allele linked to *su1*.

The inability of certain genotypes to successfully pollinate other genotypes is attributed to unique components referred to as gametophyte factors. Both male and female gametophyte functions have been described (Nelson, 1994). Gametophyte factors regulate the success of pollen-stigma interactions and are credited for the aberrant Mendelian genetic ratios in certain crosses which in turn can influence gene flow. More specifically, the female function is a unique component found in silks of select genotypes that allows for discrimination against certain pollen types. The male function, on the other hand, refers to a unique component found in pollen of select genotypes that allows the pollen to overcome the silk barrier. Though the exact interaction is still unclear, results by Kermicle and Evans (2005, 2010) suggest that incompatibility is due to the lack of matching alleles and not active rejection. Eventual cloning of the gametophytic

cross-incompatibility genes will hopefully provide insight into the molecular and biochemical mechanisms responsible for these interactions.

Gametophytic cross-incompatibility systems have been shown to play a role in isolating sympatric Mexican maize landraces with teosinte populations (Kermicle & Evans, 2010). Three gametophytic incompatibility systems in maize have been described: *Gametophyte factor-1 (Gal)*, *Gametophyte factor-2 (Ga2)*, and *Teosinte crossing barrier (Tcb1)*.

### *Gal*

*Gal* has been the most well studied gametophyte factor. It was mapped to the short arm of chromosome 4 in maize (Bloom and Holland, 2011; Liu et al., 2014; Mangelsdorf & Jones, 1926; Zhang et al., 2012). Three variants at the *Gal* locus have been identified: *gal*, *Gal-s*, and *Gal-m*. The *gal* locus is found in most conventional grain production fields (i.e. #2 yellow dent). Plants with the *gal* locus do not contain the male or female function. The *gal* haplotype can be pollinated by *gal*, *Gal-s*, and *Gal-m*; *gal* pollen is discriminated against, however, by the *Gal-s* silks (Kermicle, 2006; Kermicle & Evans, 2005; Nelson, 1952).

*Gal-s* is considered the “strong” variant of *Gal*. Plants with the *Gal-s* haplotype possess both the male and female function. *Gal-s* plants can be pollinated by *Gal-s* and *Gal-m* pollen. However, *gal* pollen fails to successfully pollinate *Gal-s*, even in the absence of competing pollen (Kermicle & Evans, 2005). When *Gal-s/gal* heterozygous plants are self-fertilized, *gal* pollen is discriminated against and virtually all seed set is by *Gal-s* pollen (Emerson, 1934). When only *gal* pollen is present, fertilization of *gal/Gal-s* silks will occur to varying degrees (Schwartz, 1950; Nelson, 1952). *Gal-m*

genotypes contain the male function only. Plants with the *Gal-m* haplotype can self-pollinate and can be used to a pollen parent to cross-pollinate *gal* and *Gal-s* plants. *Gal-m* silks can be successfully pollinated by *gal*, *Gal-m* and *Gal-s* pollen (Jimenez & Nelson, 1964; Kermicle & Evans, 2010; Kermicle et al, 2006). In the *Gal* system, Kermicle and Evans (2005) demonstrated that the presence of the dominant allele (*Gal-s* or *Gal-m*) led to successful fertilization of dominant silks; the presence of the *gal* allele was not causative of pollen tube growth arrest. A translocation B-4Sa was introgressed into the *W22* inbred line, resulting in the creation of disomic pollen grains. The disomic pollen grains verified what is now referred to as the congruity model.

### *Ga2*

*Ga2* was mapped to the long arm of chromosome 5 in maize and teosinte populations (Longley, 1960; Kermicle & Evans, 2010). Four alleles of the *Ga2* locus have been identified: *Ga2-s* (strong), *Ga2-w* (weak), *Ga2-m* (male), and *ga2* (null) (Longley, 1930, Kermicle & Evans, 2010). Past experiments suggests that *Ga2-s* is found only in teosinte lines, *Ga2-w* is found only in Mexican landraces, and *Ga2-m* is found in both teosinte and Mexican landraces. Nonetheless, *Ga2* was proven to be a parallel, but separate, system to that of *Gal* and *Tcb1* (Kermicle & Evans, 2010). All three systems contain a null allele (with no female or male function), a *-m* allele (male function only), and *-s* allele (female and male function). Similar to the experiments done with *Gal*, Kermicle and Evans (2010) created disomic pollen grain (*Ga2/ga2*). The disomic pollen was able to successfully pollinate dominant *Ga2* silks, suggesting, as in the *Gal* system, a congruity model rather than an active rejection (Kermicle & Evans, 2010).

### *Tcb1*

*Tcb1* was mapped to chromosome 4, a distance of 44 centimorgans (cM) from *Gal* and 6 cM from *su1* (Evans & Kermicle, 2001). *Tcb1* is found only in teosinte populations, unlike *Gal* and *Ga2* which are found in both maize and teosinte populations (Kermicle and Evans, 2010). Male and female factors have been described for the *Tcb1* locus. Lu et al (2014) created attenuated lineages of *Tcb1-s*, thus demonstrating that pistil function can be gradually lost via recurrent backcrossing to maize without losing pollen function.

In all three gametophytic incompatibility systems, the barrier is stronger in homozygous compared to heterozygous plants, suggesting a co-dominant effect (Kermicle & Evans, 2005). The barriers do not always exclude 100% of the incompatible pollen, however, which leads to greater difficulty in distinguishing between active pollen rejection and gametophytic incompatibility.

The gametophyte factor has been shown to interact weakly. Attenuated *Tcb1* lines were shown to be more compatible with *Gal-s* than with *gal* (Evans & Kermicle, 2001); *Gal* has been shown to weakly interact with *Ga2* as well resulting in successful fertilizations (Kermicle & Evans, 2010). All systems, however, are associated with premature pollen tube termination (Lu et al, 2014; Zhao et al, 2014). Interestingly, pollen tube growth patterns vary among incompatibility systems with incompatible pollinations. In the *Gal-s* barrier, pollen tubes do not grow straight and demonstrate heavy accumulation of clustered callose plug deposits; the *Ga2* barrier also leads to clustered callose plug deposits, with lateral kinks in the pollen tube at each callose plug site; in the *Tcb1-s* barrier, pollen tubes grow straight with spaced callose plugs (Lu et al, 2014).

Zhang et al (2012) performed a genetic analysis and *Gal-s* fine mapping study using the popcorn line SDGa25 (Zhang et al., 2012). Four BC<sub>1</sub>F<sub>1</sub> mapping populations were created with Jing24, W22, HN287, and JKN2000F lines. SDGa25 was used as a tester to phenotype the BC<sub>1</sub>F<sub>1</sub> populations. SSR markers were used to fine map the *Gal-s* locus to a 2.2 Mbp region on the short arm of chr 4. Pollen tube growth studies were also performed. The following pollen-pistil combinations were used: W22 pollen presented on SDGa25 pistils (incompatible reaction), SDGa25 pollen presented on SDGa25 pistils (compatible reaction), and SDGa25 pollen presented on W22 pistils (compatible reactions). Pollen tube growth was fixed and stained with aniline blue at 0.15, 0.5, 1, 2, 5, 10, and 20 hours. The experiment provided additional insight into the mechanism underlying an incompatible reaction. In both compatible and incompatible reactions, pollen tubes germinated and entered the transmitting tract in all cases, but once in the silk, significant differences in tube growth were observed. Pollen tubes in compatible reactions grew at a rate of 10 mm h<sup>-1</sup> versus the incompatible reactions that grew only 2.8 mm h<sup>-1</sup>. Obvious significant differences in growth were seen after two hours. After 20 hours of growth, pollen tubes in compatible reactions grew the full length of the pistil and reached the ovary; in incompatible reactions pollen tube growth arrested 5.5 cm distal to the ovule and fertilization never occurred.

Despite the amount of research that has been done on the topic of pollen tube growth, a complete picture of pollen tube growth has yet to be fully realized. The mechanisms surrounding pollen-stigma interactions also remains a question not entirely answered. Both pollen tube growth and pollen-stigma interactions do, however, remain a topic of avid interest.



### **Gametophytic Self-Incompatibility**

Similar to gametophytic cross-incompatibility, gametophytic self-incompatibility is the inability of a plant, producing both fertile male and female gametes to create zygotes after self-pollination (Nettancourt, 1977). Darwin (1877) first described self-incompatibility. He proposed that systems in which plants were unable to successfully self-pollinate were integral to the evolution of flowering plants and ultimately encouraged allogamy, also known as cross-pollination. Since the time of Darwin, self-incompatibility has been extensively researched. The genetic control of self-incompatibility varies among species. In the Solanaceae family, a single locus governs the system; in most grasses, two loci (S and Z) are responsible for the barrier (Takayama, et al., 2012); four loci control self-incompatibility in sugarbeet (Lundqvist et al, 1973).

Protein-protein interactions determine fertilization outcomes in the gametophytic self-incompatibility systems. Both the pollen and pistil produce proteins that interact during pollination. If the proteins match, as is the case in self-fertilization, pollen tube growth never occurs (active rejection); if the pollen pistil proteins do not match, the pollen tube elongates (Takayama & Isogai, 2005). The S-locus controls specific protein expression in the pistil and pollen. The locus is made up of several tightly linked genes. There exist many alleles of the S-locus.

### **Gametophytic vs. Sporophytic Incompatibility**

A main difference between gametophytic and sporophytic incompatibility reactions is the tissue type that exerts control over the system. Gametophytic-level control is contingent solely on the haplotype of the pollen or the egg (haploid tissue);

whereas, sporophytic-level control pertains to the pistil or stamen (diploid tissue) (Kermicle & Evans, 2005; Franklin-Tong & Franklin, 2003; Takayama & Isogai, 2005).

Sporophytic incompatibility, similar to gametophytic self-incompatibility is controlled by the S-locus; the proteins involved are, however, created before meiosis is complete, whereas in gametophytic incompatibility proteins are synthesized upon pollen-stigma interaction after meiosis (Franklin-Tong & Franklin, 2003; Takayama & Isogai, 2005). Another point of dissimilarity is in pollen tube arrest. In gametophytic incompatibility, the pollen tube arrests within the stigma, while in sporophytic incompatibility, the pollen tube arrests at the surface of the stigma and penetration of the style never occurs (Pandey, 1958). Roberts et al, (1980) demonstrated sporophytic control in a self-incompatibility system in *Brassica oleracea*. The research demonstrated that the pollen coat carries information for plant recognition and alterations in the pollen coat can lead to incompatibility.

As in the case of gametophytic cross-incompatibility, the pistil barrier and the genotype of the pollen grain work together to determine if pollination is compatible or incompatible (Kermicle & Evans, 2010).

### **Rationale**

The cultivation and harvest of genetically modified (GM) crops have continued to increase since the release of the first GM crop, the FlvrSvr tomato, in 1994 (USDA-ERS, 2014). Since that time, additional GM maize varieties have been created and gained popularity among US farmers. USDA-ERS (2014) reported that in 2014, 76% of all planted maize acres in the United States contained stacked traits for both herbicide tolerance (Ht) and insect resistance (Bt). A parallel increase in organic maize production

has been observed. Often fueled by consumer concerns regarding GM crops safety, increasingly large populations of consumers demand organic maize for consumption in both fresh and processed foods, as well as livestock rations. From 1995 to 2008, acreage of organic maize harvested in the United States had increased by 161,987 acres (Brester, 2012). With increasing acreage of organic maize grown alongside GM maize, the potential for cross pollination has increased as well. The USDA (2015) requires that products qualified for the USDA organic seal are void of genetically modified organisms. Being a value added, specialty product, maintaining purity of organic maize fields is an economic necessity.

The implication of controlling adventitious presence, the unwanted presence of transgenes, extends beyond assisting the organic sector of maize production. Maize biotechnology companies own patents on GM varieties and monitor the production of maize under such patents. Therefore, maintaining purity of the remaining maize market classes is of utmost concern. Successful field isolation of market classes, such as white maize used in the food industry and other specialty maize crops, such as high amylose maize and sweet corn, is difficult and cross pollination with neighboring GM fields and other non-specialty maize fields often occurs.

Steps to control pollen flow between neighboring fields can be taken. Physical borders and buffer zones are planted between GM and organic fields. Additionally, delayed plantings help ensure that neighboring fields are at differing reproductive stages. A delay of three to four days between field plantings has been recorded to reduce adventitious presence by 75% (Della Porta et al, 2008). This technique is often used in the cultivation of sweet corn. Unfortunately, pollen can travel great distances on the

wind. Maize transgenes were found as high as 47% in non-GM fields residing adjacent to GM fields (Goggi et al, 2006). Della Porta et al (2008) demonstrated that a distance greater than 100 meters must be maintained between fields to maintain a cross-contamination threshold of 0.1%. Insects can also be a source of contamination. A more accurate means to protect market classes and maintain purity of value added maize is required. A naturally occurring biological reproductive barrier, such as gametophytic incompatibility, that prevents selective cross pollination may be a better solution.

The objective of this study is to assemble re-sequencing data of the *Gal* region in maize, seeking to further examine the region of interest and potentially expose components that would lead to a greater understanding of how the system functions.

### **Challenges**

The availability of only one published reference maize sequence, B73 v3, was a major disadvantage. The ability to identify possible sequence variation between maize lines, in particular, that from which our BAC libraries was derived, would have been especially useful in this project. The lack of such reference sequences led to difficulties clearly identifying sequence gaps due to sequence variation from that of causative polymorphism. Additionally, not having a mate paired library severely hindered our ability to span gaps in repetitive regions.

The lack of effective alignment tools also posed a major challenge. Scaffold sequence that had a small overlap region with a contiguous scaffold sequence, but could be overlapped manually, prevented a more continuous coverage of our region of interest. Additionally, it was difficult to determine if indeed the sequences should be combined or were a result of a smaller region that was repeated in the region of interest. Inherent

challenges included processing large data files, visualizing genomic sequences of great length, and implicit error in gene prediction software's ability to correctly predict genes.

The DNA sequence of the intergenic space of the region of interest is extremely repetitive. Due to the abundance of transposons throughout the region of interest, many reads mapped to multiple positions not only in the region of interest, but also the genome as a whole. This genetic architecture led to difficulties in distinguishing overlapping regions of each BAC in comparison to the other three BACs.

### **Role of Student Researcher**

As student researcher, my role was to use bioinformatics tools to assemble bacterial artificial chromosome (BAC) next generation sequence data. Determination of the region of interest via a mapping study was carried out in the lab of Dr. Michael Muszynski's. Construction of the BAC library was carried out in the lab of Dr. Matt Evans. Selection of the BACs for sequencing was carried out jointly in the labs of Dr. Muszynski and Evans. I processed, aligned, and assembled reads from all BAC files. Computation was performed in a Linux environment. Sequence variation between the BAC sequences and the reference genome was identified. Additionally, in the BAC assembly process, a macro in Microsoft Office Excel was created to analyze overlapping reads mapped to the reference genome. Subsequently, this allowed for the compilation of mapped reads and the determination of an overall start and stop position of contigs, in relation to the B73 v3 reference genome, derived from overlapping reads. The project contributed sequence data, a component of published literature that until recently was absent. This absence impeded understanding of gametophytic incompatibility.

Furthermore, as part of my Master's experience, I served as a coauthor for the maize introduction chapter in the Encyclopedia of Food Grains. This contribution serves not only as writing experience, but also as a source of references for those individuals seeking additional information regarding maize. Together, this research and writing experiences serve as partial requirement for the Masters in Plant Breeding degree.

### **Thesis Organization**

This thesis is organized into four chapters. The first chapter includes an introduction to gametophytic cross-incompatibility and literature review. Chapter two describes work aimed at re-sequencing the *Gal* region of maize to be published in a peer reviewed journal. A chapter that has been accepted for publication in the Encyclopedia of Grains Science is presented in Chapter Three.

## References

- Barnabas B., Fridvalszky L. (1984) Adhesion and germination of differently treated maize pollen grains on the stigma, *Acta Botanica Hungarica*. pp. 329-332.
- Bloom J.C., Holland J.B. (2011) Genomic localization of the maize cross-incompatibility gene, Gametophyte factor 1 (*ga1*), *Maydica*. pp. 379-387.
- Correns C. (1902) *Scheinbare Ausnahmen von der Mendel'schen Spaltungsregel für Bastarde*, Gebrüder Borntraeger.
- Darwin C. (1877) *The different forms of flowers on plants of the same species*, London.
- Della Porta G., Ederle D., Bucchini L., Prandi M., Verderio A., Pozzi C. (2008) Maize pollen mediated gene flow in the Po valley (Italy): Source-recipient distance and effect of flowering time, *European Journal of Agronomy*. pp. 255-265.
- Demerec M. (1929) Cross sterility in maize, *Molecular and General Genetics*. pp. 281-291.
- Derksen J., Rutten T., Van Amstel T., A d., Doris F., Steer M. (1995) Regulation of pollen tube growth. *Acta Bot. Neerl* 44:93-119.
- Dresselhaus T., Franklin-Tong N. (2013) Male-female crosstalk during pollen germination, tube growth and guidance, and double fertilization, *Molecular plant*. pp. 1018-1036.
- Emerson R.A. (1934) Relation of the differential fertilization genes, *Ga ga*, to certain other genes of the *su-tu* linkage group of maize, *Genetics*. pp. 137-156.
- Evans M.M.S., Kermicle J.L. (2001) Teosinte crossing barrier1, a locus governing hybridization of teosinte with maize. *Theoretical and Applied Genetics* 103:259-265.

- Feijó J., Malhó R., Obermeyer G. (1995) Ion dynamics and its possible role during in vitro pollen germination and tube growth. *Protoplasma* 187:155-167.
- Franklin-Tong N., Franklin C.H. (2003) Gametophytic self-incompatibility inhibits pollen tube growth using different mechanisms, *TRENDS in Plant Science*. pp. 598-605.
- Franklin-Tong V.E. (1999) Signaling and the modulation of pollen tube growth. *The Plant Cell* 11:727-738.
- Giampiero C., Moscatelli A., Cresti M. (1997) Cytoskeletal organization and pollen tube growth. *Trends in Plant Science* 2:86-91.
- Goggi S., Caragea P., Lopez-Sanchez H., Westgate M., Arritt R., Clark C. (2006) Statistical analysis of outcrossing between adjacent maize grain production fields, *Field Crop Research*. pp. 147-157.
- Herrero M., Hormaza J.I. (1996) Pistil strategies controlling pollen tube growth. *Sexual Plant Reproduction* 9:343-347.
- Heslop-Harrison J. (1982) Pollen-stigma interaction and cross-incompatibility in the grasses. *Science* 215:1358-1364.
- Heslop-Harrison J. (1987) Pollen germination and pollen-tube growth.
- Heslop-Harrison J., Heslop-Harrison Y. (1990) Dynamic aspects of apical zonation in the angiosperm pollen tube. *Sexual Plant Reproduction* 3:187-194.
- Heslop-Harrison J., Heslop-Harrison Y. (1991) Restoration of movement and apical growth in the angiosperm pollen tube following cytochalasin-induced paralysis. *Philos. Trans. R. Soc. London Ser. B* 331:225-235.



- Jimenez J.R., Nelson O.E. (1964) A fourth chromosome gametophyte locus in maize, *Journal of Heredity*. pp. 259-263.
- Johnson M., Preuss D. (2002) Plotting a course: Multiple signals guide pollen tubes to their targets. *Developmental Cell* 2:273-281.
- Kermicle J. (2006) The *gametophyte-1* locus and reproductive isolation among *Zea mays* subspecies, *Maydica*, *Maydica*. pp. 219-225.
- Kermicle J.L., Evans M.M.S. (2005) Pollen-pistil barriers to crossing in maize and teosinte result from incongruity rather than active rejection. *Sexual Plant Reproduction* 18:187-194. DOI: 10.1007/s00497-005-0012-2.
- Kermicle J.L., Evans M.M.S. (2010) The *Zea mays* sexual compatibility gene *ga2*: Naturally occurring alleles, their distribution, and role in reproductive isolation, *Journal of Heredity*
- Knox R.B. (1984) Pollen-pistil interactions, *Encyclopedia of Plant Physiology*. pp. 508-608.
- Lausser A., Kliwer I., Srilunchang K.O., Dresselhaus T. (2010) Sporophytic control of pollen tube growth and guidance, *Journal of Experimental Biology*. pp. 673-682.
- Lu Y., Kermicle J.L., Evans M.M.S. (2014) Genetic and cellular analysis of cross-incompatibility in *Zea mays*. *Plant Reproduction* 27:19-29. DOI: 0.1007/s00497-013-0236-5.
- Lundqvist A. (1956) Self-incompatibility in rye, *Hereditas*. pp. 293-348.
- Mangelsdorf P.C., Jones D.F. (1926) The expression of Mendelian factors in the gametophyte of maize, *Genetics*. pp. 423-455.

- Mascarenhas J.P. (1993) Molecular mechanisms of pollen tube growth and differentiation. *The Plant Cell* 5:1303-1314.
- Nelson, O.E. 1952. Non-reciprocal cross-sterility in maize. *Genetics*. p. 101.
- Nelson OE. (1994). The gametophyte factors of maize. In: Freeling M, Walbot V, editors. *The maize handbook*. Berlin (Germany): Springer-Verlag. p. 496–503.
- Nettancourt D. (1977) Incompatibility in angiosperms, Springer, Berlin Heidelberg.
- Pandey K.K. (1958) Time of the S allele action, *Nature*. pp. 1220-1221.
- Pierson E., Lichtscheidl I., Derksen J. (1990) Structure and behavior of organelles in living pollen tubes of *Lilium longiflorum*. *Journal of Experimental Biology* 41:1461-1468.
- Read S., Clarke A., Bacic A. (1993) Stimulation of growth of cultured *Nicotiana tabacum* W38 pollen tubes by poly (ethylene glycol) and Cu(II) salts. *Protoplasma* 177:1914.
- Steer M., Steer J. (1989) Pollen tube tip growth. *New Phytol* 111:323-358.
- Takayama S., Isogai A. (2005) Self-incompatibility in plants, *Annual Review of Plant Biology*. pp. 467-489.
- USDA. (2015) Organic Agriculture.
- USDA-ERS. (2014) Adoption of genetically engineered crops in the U.S.: Recent trends in GE adoption.
- Zhang H., Liu X., Zhang Y.E., Jiang C., Cui D., Liu H., Li D., Wang L., Chen T., Ning L., Ma X., Chen H. (2012) Genetic analysis and fine mapping of the *Ga1-s* gene region conferring cross-incompatibility in maize, *Theoretical and Applied Genetics*. pp. 459-465.

## CHAPTER TWO: RESEQUENCING OF THE GAMETOPHYTIC INCOMPATIBILITY REGION IN MAIZE

### Abstract

Gametophytic cross-incompatibility is as a biological barrier to cross pollination, preventing promiscuity between neighboring transgenic maize and organic maize fields. Interest in deploying gametophytic cross-incompatibility genes in maize to reduce unwanted pollination has fueled recent research on the topic. We identified and sequenced four BACs spanning the *Gamephototype factor-1 (Gal)* locus of a line carrying the *Gal-m* allele to better understand and characterize the male function in this gametophytic cross-incompatibility system in maize. Comparison of de novo assemblies to assemblies based on the B73 genome scaffold suggest there are extensive differences between the B73 sequence and the genome of the line the *Gal* region was introgressed from. We therefore focused on de novo assemblies to characterize this region. A de novo assembly was performed for each of the four BACs. Repetitive sequences prevented unambiguous assembly of complete BAC sequences. The resulting contigs were compared to the region of interest in B73 to identify polymorphisms that may be responsible for *Gal* action. Clear homology was identified between BAC contigs and six predicted genes and one transposable element in the B73 version 3 (v3) reference sequence. Polymorphisms are found in each of these genes. Six additional predicted B73 genes and two transposable elements could not be found in the *Gal-m* region despite evidence of overlapping BAC coverage of the region in which they are found. In addition, 11 genes were predicted in our de novo assembled contigs that are not predicted

in B73. These sequence differences are candidate polymorphisms for the gametophytic cross-incompatibility function.

### **Introduction**

There are practical applications of gametophytic cross-incompatibility as a biological barrier. It could be especially useful in specialty maize crop systems where controlling xenia effects directly influences the value of the crop. For example, if gametophytic cross-incompatibility systems are incorporated into an organic maize system, organic maize fields could be grown alongside neighboring transgenic maize fields with reduced transgene contamination.

Past studies have resulted in successful fine-mapping of the *Gal* cross-incompatibility locus. However, to our knowledge, causative polymorphisms or causative genes have yet to be characterized. Using a mapping approach with two populations, Bloom and Holland (2012) mapped *Gal-s* to a region on the short arm of chromosome 4. Mapping in the population B73 x Hp301 NAM RILs localized the *gal* interval to 6,408,214 to 12,609,493 bp on the short arm of chromosome 4 in the B73 version 2 reference genome. Additionally, a diverse set of lines for which genotyping-by-sequencing (GBS) data are available were screened at SNP loci within the *Gal* region for markers that co-segregate for the pollen exclusion phenotype. Two predicted genes homologous to sucrose-phosphate synthase genes in other plants: GRMZM2G068698 and GRMZM2G008507 were identified by this process. The W22 x *Gal-s* *Su-1* mapping population delineated the *Gal-s* locus between 7,133,675 and 13,398,777 bp in the B73 AGP version 2 reference sequence. The identified region overlaps with the 2.2 Mbp (million base pairs) region previously identified by Zhang et al. (2012).

More recent studies have further delineated the *Gal-s* locus. Liu et al (2014) defined the region to 9,491,422 to 9,591,946 bp on the short arm of chromosome 4. The study utilized a homogenous mapping population (*Gal-s* BC<sub>1</sub>F<sub>1</sub>) derived from a popcorn line (SDGa25) and a Chinese line carrying the null alleles for gametophytic cross-incompatibility (Jing66), which allowed the authors to further define the region. The need for phenotyping was eliminated by taking advantage of the gametophytic cross-incompatibility system. During the creation of the population, only *Gal-s* pollen would successfully pollinate *Gal-s* plants; therefore, the resulting progeny were *Gal-s/Gal-s*. The population was screened using 14 closely-linked markers and five tightly-linked markers derived from the B73 version 2 reference genome. The work identified gene GRMZM2G039983 in the B73 reference genome as a potential candidate gene for causation of the gametophytic cross incompatibility system. The predicted gene was found to have homology to WDL1 in *Arabidopsis* which controls anisotropic cell growth and was hypothesized to have an effect on pollen tube growth. The potential role of GRMZM2G039983 has not been elucidated. After identifying a narrow region of interest, the authors demonstrated an integration proof of concept. *Gal-s* was successfully introgressed into an elite waxy maize hybrid using marker assisted selection. These results illustrate the utility of molecular information about the locus for transfer of this trait among varieties.

Kermicle and Evans (2005) demonstrated that incongruity between pollen and silk, rather than active rejection, is responsible for the *Gal* function. These results suggest the need for a harmonious interaction between a female factor in the silks with a male factor in the pollen. The *gal* locus has been classified as a null allele (Kermicle,

2006). It is not understood if the null effect is due to the presence/absence of gene(s) conferring male and female functions or sequence variation(s) in genes in the region. In this project, we use of the *Gal-m* haplotype as a means to isolate the male function. Isolation and classification of the male function may bring clarity to the role of the female function and assist in better understanding pollen-pistil interaction as a whole. The goal of this study was to understand the *Gal* locus at the molecular level. This was accomplished by resequencing four BACs derived from a *Gal-m* variety. Through alignments to the *gal/gal* inbred line B73, we seek to identify the inserted and deleted genes, as well as polymorphisms within genes in an identified region of interest. With such information, we hope to deduce how sequence variations could contribute to the male function in gametophytic cross incompatibility.

### **Materials and Methods**

#### BAC library construction, BAC selection, and sequencing

Dr. Matthew Evans at Stanford University created a BAC library from a W22 inbred line containing the *Gal-m*, *Ga2*, and *Tcb1* alleles (Kermicle & Evans, 2010). The BAC vector pIndigo-BAC5-Hind III was used in DH10B *E coli* cells. The CopyControl™ BAC Cloning Kit was used to create the BAC library. The BACs had a predicted average insert size of 120 kilobases (kb). Chloramphenicol resistance was used as a selectable marker.

Primers designed to amplify gene sequences found in the B73 region of interest, namely AC184772, GRMZM5G817995, GRMZM2G419836, GRMZM2G027021, and GRMZM2G039983, were used to identify BACs near the *Gal* locus using PCR (Table 2.1). Primer set GRMZM2G027021 was not successful in identifying a BAC. The other

four primers identified a total of one BAC per primer pair. The four BACs will be hereafter referred to as BAC1, BAC2, BAC3, and BAC4. Each BAC was sequenced at the Iowa State University DNA facility using 300 bp single end Illumina Mi-Seq technology.

Table 2.1. Markers used to identify BACs.

BAC	Gene model	Primer sequence	Amplicon size
1	AC184772.3	F: AGCTGTGTGGGGTTCTATGCGAGT R: TAGAATCCTAGCTCCTACAGCGAAGCC	350 bp
2	GRMZM5G817995	F: TCCAACCTTTTGCTTCTTTTGATGCAC R: CGCAACCTTTGAGTAACTCTTAGC	620 bp
3	GRMZM2G419836	F: CTCCCCTCGTCTGCTTCAAATGGC R: AGAGAACAGAGCACCCAAATCGGC	640 bp
4	GRMZM2G039983	F: AAGCAGCGCTGCACAGTGGCAA R: AAGCTGGGCAGGAGGAAGACGG	578 bp

#### Preparing sequence reads for assembly

Unless otherwise noted, all bioinformatics work was completed on the USDA server, Lathyrus. The server is a Linux based system with 64 central processing unit (CPU) cores. It is maintained by the Corn Insects and Crops Genetics Research Unit located on the Iowa State University campus.

In the first step of processing the BAC sequence files, scythe was used to remove adapter sequences from reads (Buffalo, 2014). The sickle plugin was used to trim bases with a quality score of less than 20 and reads shorter than 50 bp in length. Using the FASTX-Toolkit, fastx\_trimmer was used to remove the first 15 bases of each read due to low quality base calls in that region (Pearson et al., 1997). Unique identifiers replaced original reads names. The deconseq plugin was used (Schmieder et al., 2011) to remove contaminating sequences derived from *Escherichia coli* (*E. coli*). Reads that matched the *E. coli* genome at 95% identity or better, with greater than 5% coverage, were deleted.

The remaining sequences were considered high quality reads. High quality reads averaged 280 bp in length.

#### Scaffold-based assembly of BAC sequences

High quality reads were aligned to chromosome 4 of the *Zea mays* v3 reference genome, obtained from Ensembl Plant (Julian et al, 2014), by BAC. Processed read files were subjected to the Burrows-Wheeler Aligner (BWA) pipeline (Li & Durbin, 2009). Post alignments, reads were divided into two groups: (1) reads that mapped to the region of interest and (2) reads that did not map to the region of interest.

#### *Analysis of mapped reads*

Positional data from mapped reads was extracted and used to identify sequences that overlap. Overlapping read sequences were formed into contigs by determination of contig start and stop positions on the reference genome; these contigs will be referred to as mapped contigs, hereafter. Mapped contigs were visualized on a custom track using the MaizeGDB Genome Browser (Figure 2.4) (Monaco et al., 2013).

#### *Analysis of unmapped reads*

The unmapped reads were subjected to de novo assembly using the MIRA 4.0.2 program (Chevreux et al., 1999) and the resulting contigs will be referred to as unmapped contigs hereafter. Parameters used in the MIRA 4 manifest file are as follows:



*job* = genome, denovo, accurate

parameters = -GE:nt=16 (16 general number of threads)

parameters = SOLEXA\_SETTINGS -CO:msr=no (tells MIRA to not merge identical reads to backbone, thus maintaining distance and orientation information)

technology = solexa

Nucleotide-Nucleotide BLAST 2.2.30+ (blastn) (Altschul et al., 1990) was used to compare unmapped contigs to the region of interest in B73. An e-value of 0.0001 was used and the default value was used for all other blastn parameters.

#### De novo assembly of all high quality reads by BAC

Parameters used in the MIRA manifest file are identical to those used above for assembly of the unmapped reads, except all high quality reads from each BAC were assembled separately to give four sets of contigs, one from each BAC.

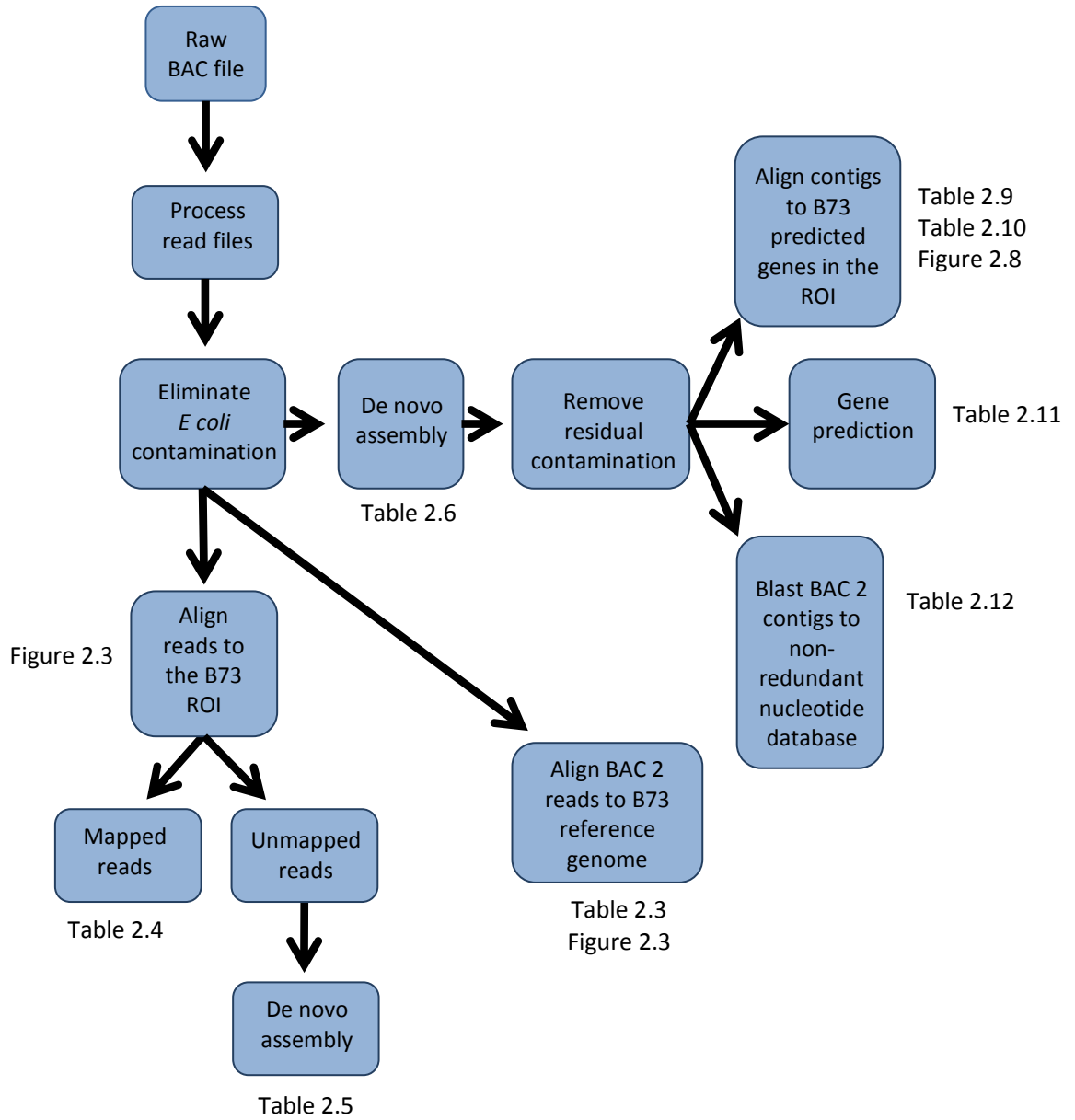

Figure 2.1. BAC assembly pipeline.

### *Gene prediction*

Assembled contigs 5 kb (thousand basepairs) and greater in length were subjected to gene prediction using Softberry website FgenesH (Salamov & Solovyev, 2000). FgenesH ab initio gene prediction is based on monocot plant specific, trained parameters.

### *Gene annotation*

Assembled contigs 5 kb or greater in length were blasted to the NCBI non-redundant nucleotide database. The following parameters were used: expected threshold: 10; Mismatch score: 1-2; Gap cost: linear; automatically adjust parameters for short sequences allowed. (Altschul et al, 1990). Threshold values used to declare significance were an e-value of 0.0, identity score of 15% and greater, and a query coverage of 85% and greater.

### *Removal of residual contamination*

MIRA 4 assembly files from each BAC were blasted to the Univec database to identify residual sequence contaminants. BAC contigs that blasted to entries in the database with an e-value of .0001 or less were removed.

## **Results and Discussion**

### Identification of the region of interest

Studies completed by Bloom and Holland (2012), Zhang et al. (2012), Liu et al. (2014), and unpublished work by Dr. Michael Muszynski, identified a region likely to contain the *Gal* locus. In this study we used a region of interest from 9.1 to 9.6 Mbp on the short arm of chromosome 4. In the B73 v3 reference genome, there are six protein coding genes and six low confidence genes characterized, ranging from 113 bp to 9,640 bp in length. Additionally there are three transposable elements situated in the latter half

of the region that range from 556 to 56,722 bp in length. Figure 2.2 summarizes the region of interest. Table 2.2 presents additional details of the region of interest including the model type of each gene (low confidence, protein coding, or transposable elements), as well as, the start and stop position and orientation.

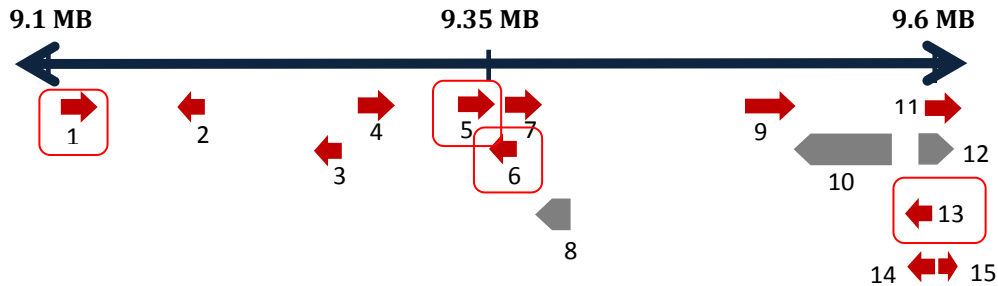

Figure 2.2. Predicted gene model in the region of interest for B73 v3 reference genome. Red arrows represent genes; grey arrows represent transposable elements. Boxed genes were used in BAC marker sequences.

Table 2.2. Position, strand, and model type of predicted genes in the B73 v3 reference genome.

Gene #	Gene	Model type	Start	Stop	Strand
1	AC184772.3_FG001	LC	9,106,014	9,106,855	Forward
2	AC201986.3_FG002	PC	9,187,173	9,187,685	Reverse
3	GRMZM2G702344	PC	9,263,791	9,264,870	Reverse
4	GRMZM2G122484	LC	9,272,045	9,272,566	Forward
5	GRMZM5G817995	PC	9,329,468	9,329,770	Forward
6	GRMZM2G419836	PC	9,355,159	9,358,375	Forward
7	AC205010.4_FG001	LC	9,358,025	9,359,830	Reverse
8	GRMZM2G535727	TE	9,375,747	9,375,860	Reverse
9	GRMZM2G027021	PC	9,490,258	9,499,402	Forward
10	GRMZM2G027368	TE	9,517,545	9,574,267	Reverse
11	AC204382.3_FG010	LC	9,588,810	9,589,611	Forward
12	GRMZM2G507805	TE	9,589,653	9,590,209	Reverse
13	GRMZM2G039983	PC	9,594,061	9,597,440	Reverse
14	GRMZM2G039971	LC	9,597,755	9,598,020	Reverse
15	GRMZM2G039928	LC	9,598,535	9,599,547	Forward

LC= low confidence; PC= protein coding; TE= transposable element

The BAC library was screened using the primers found in Table 2.1. Primer sequences originated from predicted genes in the region of interest. Marker placement is shown in Figure 2.7. We verified the presence of marker sequences in assembled contigs.

Four BACs were identified as containing molecular markers in the region of interest. Post sequencing, BAC 1 yielded 3,526,222 reads; BAC 2 yielded 4,995,350; BAC 3 yielded 1,849,985; BAC 4 yielded 2,472,846 reads. Average read length after processing is 280 bp.

We first sought to determine what proportion of reads mapped to the entire B73 reference genome, or if they mapped to the genome at all. We used the genome alignment exercise to verify that the BACs were derived from the region of interest. Since BAC 2 generated the largest number of reads and was hypothesized to reside in the middle of the region of interest, it was selected for this analysis. Visualization of BAC 2 reads mapped to the entire B73 reference genome, using BWA, revealed that the highest density of reads is indeed within the region of interest located on chromosome 4 (Figure 2.3). Homology to BAC sequences was found outside of the region of interest as well.

Read mapping outside of the region of interest could be the result of one or more of the following: 1) reads map to repetitive regions found inside and outside of the region of interest, 2) the region of interest in the *Gal-m* haplotype is smaller than B73; BAC sequences, therefore, extend out of the region of interest defined by the B73 reference genome, and/or 3) the sequences of the BACs may differ from that of B73. These variations could be the result of genome rearrangements where sequences are not

deleted from the genome, but simply moved to a new genomic location (Springer et al., 2009).

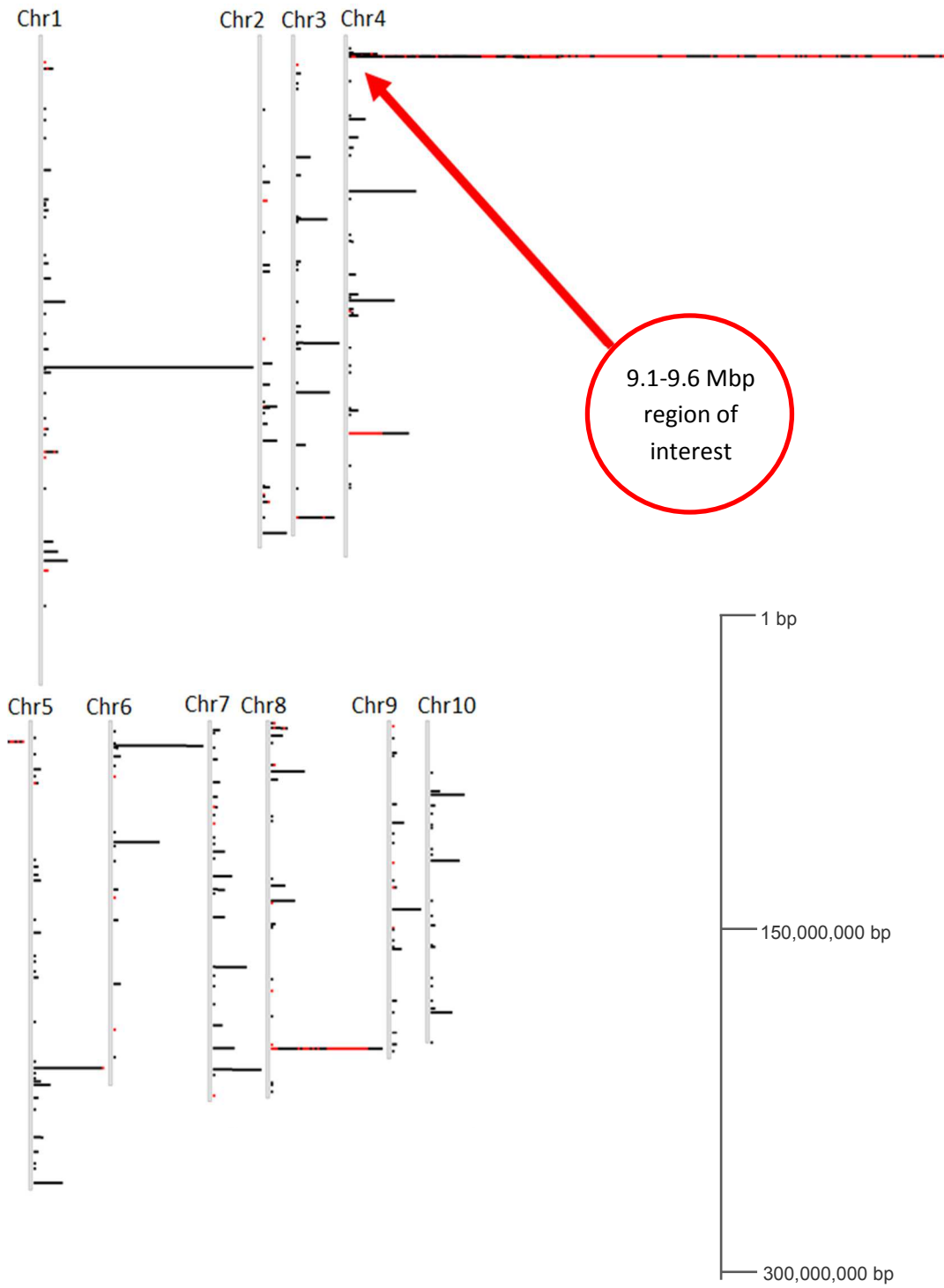

Figure 2.3. Visualization of BAC 2 reads mapped to the entire B73 genome.

Of all BAC 2 reads, less than 3% mapped to regions outside the region of interest. 20% of total BAC 2 reads mapped to the genome. These results can be seen in Table 2.3. It was therefore concluded that BAC 2 originated from the identified region of interest. Some of the reads not mapping to the genome could be the result of sequence differences in *Gal-m* and not in B73. Residual contamination may also have resulted in unmapped reads.

Table 2.3. BAC 2 BWA alignment to the B73 genome vs region of interest.

	<b>Number of reads</b>	<b>Percent of total reads</b>
Total reads	4,995,350	
Reads mapped to region	889,424	17.8%
Reads mapped outside of region	122,932	2.5%
Reads mapped to genome	1,012,356	20.3%

High quality reads per BAC were then mapped to the region of interest of B73 using BWA. The distribution of the mapped reads is shown in Figure 2.4. A small proportion of reads map to locations across the region of interest. We believe this result is once again due to the mapping of repetitive reads. The majority of the aligned reads for each BAC fall within the same genomic region as the marker sequence (and corresponding gene) used to select the BAC, verifying hypothesized BAC order. The distribution of the mapping locations of reads from each BAC suggest that BACs do originate from the region of interest and do so in an overlapping BAC arrangement. Collectively, we conclude the following BAC order: BAC 1, BAC 2 and BAC 3, and BAC 4, with BAC 3 falling within BAC 2.



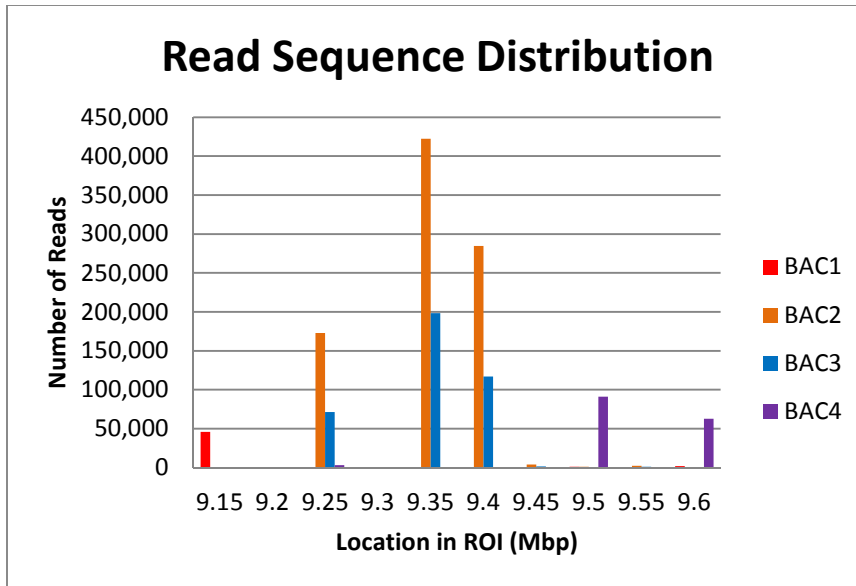

Figure 2.4. BAC read sequence distribution over the B73 region of interest.

Two different approaches (Figure 2.1) were used to assemble the sequence reads. The first approach was a comparative genome assembly. Reads are first mapped to the B73 reference genome and those that did not map to the region were subjected to de novo assembly. This was accomplished as follows.

Step One: Read files from each BAC were aligned to the region of interest using BWA. The percentages of reads that map to the region are presented in Step 1 of Table 2.4. BAC 1 (1.4%) and BAC 4 (6.4%) have a much lower percentage of mapped reads compared to BAC 2 (17.8%) and BAC 3 (21.1%). A lower quantity of mapped reads from BAC 1 and BAC 4 and alignment of BAC 1 and 4 to the boundaries of the region of interest suggest that these BACs extend out of the region of interest.

Location and number of reads mapped to the reference genome are not identical across BAC sequences; however, some mapped regions are shared between BACs. These similarities and differences in coverage suggest overlap, but of four distinct BACs.

Some part of the region of interest contained no mapped reads.. We believe these gaps in coverage are the result of sequence differences between the BACs and B73.

Step Two: The reads that did not map to the region were subjected to de novo assembly (Step 2 in Table 2.5). Compared to the mapped reads, the de novo assembled reads resulted in contigs with greater overall length. The percentage of unmapped reads assembled into contigs from each BAC ranged from 16%-28% (ranked from lowest to highest: BAC 3, 4, 2, 1). BAC 1 and BAC 2 have slightly higher percent read usage and a substantially larger number of total contigs (1,083 and 1,249); however, average contig length is on average 1.5 fold smaller (757 bp and 755 bp). Data suggest that assembly of BAC 1 and BAC 2 unmapped reads resulted in a myriad of short contigs that cannot be assembled into longer contigs. Fewer unmapped reads were used in BAC 3 and BAC4 compared to BAC 1 and BAC 2. The number of contigs is smaller (213 and 360); however, average contig length is much higher (1,170 bp and 1,084 bp), possibly a result of fewer mapped reads being removed.

Overall, unmapped reads yielded a greater number of contigs that are, on average, over 2.5 fold longer than mapped contigs. Additionally, more unmapped reads are assembled in comparison to mapped reads. Interestingly, the number of reads per contig base for mapped contigs is much higher than unmapped contigs. This result may be due to mapped contigs representing reads that are derived from repetitive regions. For example, if there are two similar regions in the region of interest (repetitive region 1 and repetitive region 2), the reads derived from repetitive region 1 and reads derived from repetitive region 2 will both map to region 1. This would cause the coverage of such repetitive regions to be artificially inflated. This may explain why the coverage of the

mapped contigs is high. This would also suggest that the unmapped contigs are unique sequences and may be also unique to the *Gal-m* genome.

Table 2.4. Summary of comparative genome assembly: Mapped reads.

Step 1: BWA- Identifying mapped reads					
	<b>BAC 1</b>	<b>BAC 2</b>	<b>BAC 3</b>	<b>BAC 4</b>	<b>Total</b>
<b># Rds/BAC</b>	<b>3,526,222</b>	<b>4,995,350</b>	<b>1,849,985</b>	<b>2,472,846</b>	<b>12,840,834</b>
<b># Rds mapped to region of interest</b>	51,063	889,424	390,147	159,069	1,489,703
<b>% Rds mapped</b>	1.4%	17.8%	21.1%	6.4%	11.6% (Avg)
<b># Contigs</b>	209	180	124	119	632
<b># Rds used in contigs</b>	50,508	889,361	390,083	159,000	1,458,952
<b>% Rds used</b>	99%	>99%	>99%	>99%	>99%
<b>Avg contig length (bp)</b>	181	313	407	382	301
<b>Avg #Rds/contig</b>	242	4,941	3,146	1,336	2,308
<b>Total length of contigs</b>	37,752	56,396	50,421	45,474	190,043
<b># Rds/contig base</b>	1.3	15.8	7.7	3.5	7.7

Table 2.5. Summary of comparative genome assembly: Unmapped reads.

Step 2: De novo assembly of unmapped reads					
	<b>BAC1</b>	<b>BAC2</b>	<b>BAC3</b>	<b>BAC4</b>	<b>Total</b>
<b># Rds/BAC</b>	3,475,159	4,105,926	1,459,838	2,313,777	11,351,131
<b># Rds in contigs</b>	558,957	725,206	232,077	648,703	2,164,029
<b>% Rds used</b>	16.1%	17.7%	15.9%	28.0%	19.1% (Avg)
<b># Contigs</b>	1,046	1,292	248	405	3,068
<b>Avg contig length (bp)</b>	764	748	1,083	1,026	811
<b>Avg # rds/contig</b>	534	561	936	1,602	705
<b>Total length of contigs</b>	799,118	966,157	268,669	415,684	2,487,382
<b># Rds/contig base</b>	0.7	0.8	0.9	1.6	0.9

Visualization of the positions of the mapped reads in the region of interest, aligned with BWA, is shown in Figure 2.4. The gaps between clusters of mapped reads suggest there are many differences between the B73 reference genome and the BAC sequences. Sequence variation among maize lines is known to exist (Fu & Dooner, 2002). Not only organization of gene sequences, but also intergenic retrotransposon sequence can drastically differ between inbred lines (Fu & Dooner, 2002; Springer et al.,



assembling the mapped and unmapped reads separately is that that neither set contains the reads necessary to assemble large contigs. Our results suggest that the BACs consist of sequences that map to the reference genome, frequently interspersed with sequences that don't map to the reference genome. We reasoned that it may be possible to obtain longer contigs by assembling all of the reads from a BAC in one de novo assembly. The use of a reference genome has been used in previous research to address such situations (Pop et al., 2003). However, as shown in the mapping results of this project, there exists too much sequence variation and possible genome rearrangements for the use of a reference genome to be of much benefit in assembly the BAC sequences. A new assembly approach was sought.

#### De novo assembly by BAC

Our approach was to assemble the BAC files as completely as possible without aid of the reference genome and then align the resulting contigs to homologous portions of the reference genome. Post assembly comparison of the B73 reference genome and BAC contigs should highlight sequence differences that are candidates for causative polymorphisms responsible for gametophytic cross-incompatibility. Therefore, each BAC file was subjected to individual de novo assemblies.

Compared to the data derived from the mapped and unmapped assemblies, whole BAC de novo assembly yielded contigs that were much longer with greater total contig length. Assembled contigs were blasted against the Univec database by BAC to determine the extent of residual contamination. A total of 289 assembled contigs were identified as containing contamination. A total of 459,690 bp of contaminants were

removed across all BAC files. Remaining contigs are believed to be of high quality BAC sequences.

BAC reads were screened for *E coli* sequence using deconseq and the *E coli* genome before assembly; however, residual contamination remained at the read level. It is possible that the cloning vector, DH10B *E coli*, contain a slightly different genome than that found in the *E coli* database. Genome variation could cause contamination to not be fully removed. Contig contamination was also derived from Enterobacteria. The Enterobacteria classification extends to include more genera of bacteria than *Escherichia*, such as *Salmonella* and *Shigella*, and could further explain why all contamination was not removed. Furthermore, if sequencing errors were present in the reads, accurately identifying *E coli* sequences at the 95% identity may become difficult and may lead to the reads not being removed.

Combined BAC de novo assembled contig length, after the removal of contaminated contigs, totaled 2,109,499 bp. BACs appeared to overlap substantially to cover the entire region of interest, suggesting actual length of the region is lower than combined total contig length. Individual de novo assembly results before and after sequence contamination removal can be seen in Table 2.6. The distribution of contig lengths for each BAC file demonstrates that the assembly process yielded many small contigs. Across BAC files, contigs 5 kb and greater accounted for approximately 0.4% to 2.5% of total contigs per BAC files. These results can be seen in Figure 2.6.

Table 2.6. Results from individual de novo assemblies of BAC files before and after contamination removal.

<i>Before contaminate removal</i>	<b>BAC 1</b>	<b>BAC 2</b>	<b>BAC 3</b>	<b>BAC 4</b>
<b>Total number of reads</b>	3,526,222	4,995,350	1,849,985	2,472,846
<b>Number of reads assembled</b>	557,271	695,794	199,820	333,466
<b>Total length of contigs (bp)</b>	867,582	1,026,154	261,723	419,774
<b>Number of contigs</b>	1,113	1,380	235	381
<b>Largest contig (bp)</b>	38,064	25,649	78,062	36,895
<b>Average coverage</b>	179	406	377	353
<i>After contaminate removal</i>				
<b>Total number of reads</b>	2,968,951	4,299,556	1,650,165	2,139,380
<b>Number of reads assembled (bp)</b>	354,926	348,137	12,676	262,507
<b>Total length of contigs (bp)</b>	750,013	871,928	141,782	345,776
<b>Number of contigs</b>	1,028	1,257	192	343
<b>Largest contigs (bp)</b>	17,149	25,649	6,150	36,895
<b>Average coverage</b>	591	700	3,265	370

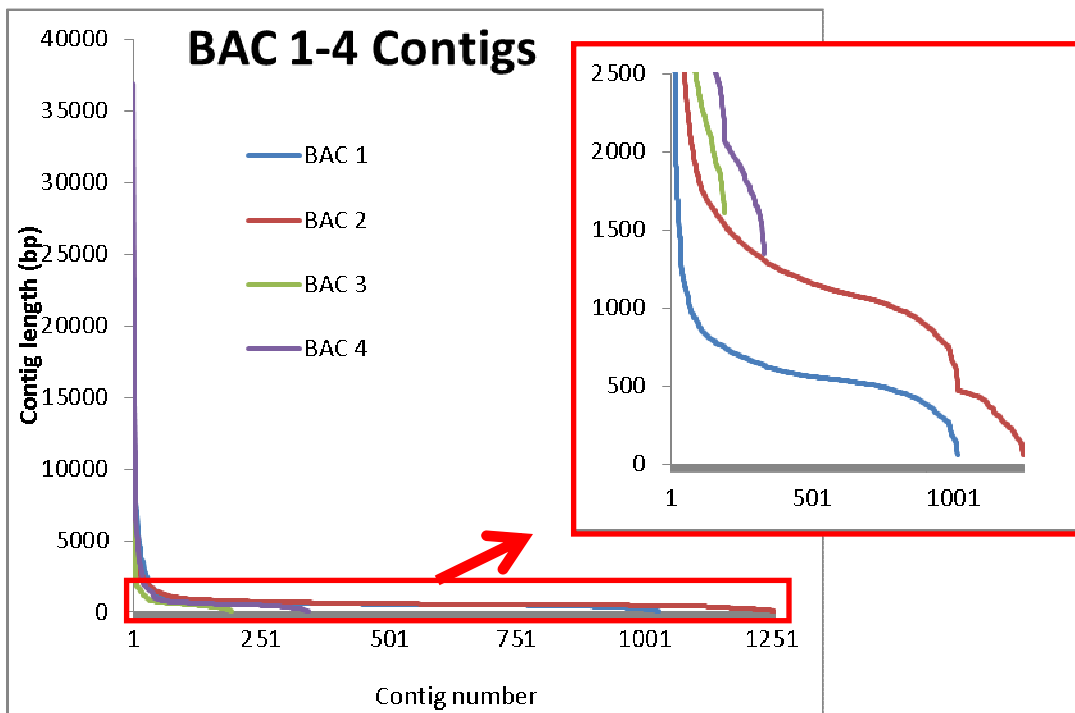

Figure 2.6. Distribution of contig length of MIRA 4 assembled contigs by BAC after contamination removal.

Despite the creation of longer contigs in individual de novo assemblies, there remained a large number of reads that were not assembled, as well as, many short

contigs. Contig breaks and unassembled reads may be the result of repetitive regions (interspersed between successfully assembled regions) that were difficult to assemble. De novo assembly literature refers to repetitive reads as the biggest impediment to assembly (Phillippy & Schatz, 2008). MIRA 4 aborts contig extension, labeling the contig with “rep”, in a situation in which one or more reads could be used to extend the contig and/or the contigs contains repetitive sequence. Instead of inaccurately assembling sequences, contig extension is stopped. In the BAC files (1-4), the percentage of “rep” contigs in comparison to total number of contigs are as follows: 76%, 79%, 55%, and 60%. These numbers demonstrate that over half of the contigs from each BAC file was stopped due to occurrences of repetitive regions. These results likely explain why the assembly yielded many contigs.

Several MIRA4 parameters were altered in attempt to optimize the assembly and utilize more reads to create longer contigs. These results can be seen in Table 2.7. The altered parameters did change the MIRA 4 output; however, no substantial effects were observed. Because of the lack of significant improvements, we went forward with the more stringent parameters from the initial assembly.



Table 2.7. Parameter optimization for de novo assembly.

Denovo assembly	Parameters altered	Total reads	Longest contig	Number of contigs	Total length	N50 contig size	Total avg coverage	Notes
1		694,468	25,773	1,404	1,043,218	656	1651.83	
2	AS:ard=no	693,875	31,448	1,412	1,044,318	669	1690.50	automatic read detection
3	AS:urd=no	692,255	31,448	1,434	1,058,057	664	1596.03	uniform read distribution
4	AL:mo=10	746,108	30,602	2,048	1,420,361	636	1765.04	minimum overlap
5	HS:ldn=no	693,488	42,262	1,442	1,064,815	673	1599.73	mask repeats in reads; small reads will not span repeats and will be put in debris file
6	SK:percent_ required=50	691,900	26,740	1,460	1,079,847	668	1649.28	controls relative % of exact matches for overlap (typically in sync with – AL:mrs)
7	SK:percent_ required=30	694,184	28,900	1,408	1,046,836	671	1635.38	compare to above
8	HS:mnr=yes	692,672	26,741	1,447	1,071,580	670	1637.84	mask nasty repeats
9	AL:mrs=75	662,567	32,662	2,365	1,641,010	655	1601.24	minimum relative score (typically set at 95)
10	AL:mo=10  Hs:ldn=no  AL:mrs=75	710,363	22,257	3,380	2,300,261	657	1593.06	

Contigs that cannot be increased in length and remaining unassembled reads could be the result of several situations. Sequencing errors in the read files may exist. Despite trimming reads to increase read quality, the files may remain error prone. Sequencing errors would prevent overlapping reads from being assembled. If overlapping reads have especially high coverage, or are repetitive in nature, MIRA4 would not assemble these regions either. Classification of repetitive reads shown in Table 2.8 suggests that many reads have been indeed tagged as “crazy” repeats and “nasty” repeats. Most reads assembled had average coverage; however, some reads did have above average coverage. Small contigs of low coverage could also be problematic and lead to a higher number of contigs. Our data, however, does not suggest that low coverage is a problem in the assembly.

Table 2.8. Read coverage and repeat classification.

BAC	Coverage classification			Repeat classification			
	HAF2	HAF3	HAF4	HAF5	HAF6	HAF7	MNRr
1	0	479,061	41,440	0	1,342	3,527,253	3,554,658
2	0	619,285	62,513	0	1,771	4,968,939	1,435,064
3	0	210,861	0	0	278	1,925,053	1,926,413
4	0	337,760	28,398	0	671	2,585,096	2,590,338

HAF5-repeat; HAF6-heavy repeat; HAF7-crazy repeat

HAF2-low coverage; HAF3-average coverage; HAF4-above average coverage

Furthermore, contamination at a different molar concentration than the BAC DNA, as well, chemical-physical properties of the genome (such as GC rich regions) could lead to erroneous, biased coverage and lead to assembly challenges. Additionally contig alignments to the B73 genome reveal that overlapping contigs marked as “rep” are not assembled into a consensus sequence during the de novo assembly. Because of this, and the high number of “rep” contigs present, many overlapping contigs are not

combined. This may explain the high number of contigs present in the assembly and why total contig length exceeds the length of the region of interest.

We next sought to compare differences in the de novo assembled contigs and the B73 reference genome in an effort to identify candidate gene polymorphisms responsible for gametophytic cross-incompatibility. We first used BWA to align genes predicted in B73 to our BAC contigs (Table 2.9).

Table 2.9. Genes from B73 reference genome present in BAC contigs determined by BWA alignment.

Gene #	Predicted genes in reference genome		BAC 1	BAC 2	BAC 3	BAC 4
1	AC84772.3	LC	X	X		X
2	AC201986.3	PC				
3	GRMZM2G702344	PC				
4	GRMZM2G122484	LC				
5	GRMZM5G817995	PC	X	X	X	X
6	GRMZM2G419836	PC	X	X	X	X
7	AC205010.4	LC				
8	GRMZM2G535727	TE				
9	GRMZM2G027021	PC				X
10	GRMZMG027368	TE	X	X	X	X
11	AC204382.3	LC				
12	GRMZM2G507805	TE				
13	GRMZM2G039983	PC		X		X
14	GRMZM2G039971	LC		X		X
15	GRMZM2G0339928	LC				

LC: low confidence; PC: protein coding; TE: transposable element

\*Shaded cell indicates a previously identified putative gene by Liu et al. (2014).

Alignments of predicted gene sequences from the region of interest and assembled contigs from each BAC reveal sequence homology with genes 5 (GRMZM5G817995) and 6 (GRMZM2G419836) to all BACs. Predicted gene 1 (AC184772.3), 9 (GRMZM2G027021), 10 (GRMZM2G027368), 13 (GRMZM2G039983), and 14 (GRMZM2G039971) also clearly align to assembled contigs from at least one BAC. The functions of these genes have yet to be determined;

however, 3 of the genes we found in the BAC sequences do contain characterized conservative domains. Predicted gene 1 (AC184772.3) contains a thioredoxin-like fold conserved domain; predicted gene 9 (GRMZM2G027021) has a GTP-binding protein hgIX domain; and predicted gene 13 (GRMZM2G039983) has an XKlp2 targeting protein conserved domain.

Genes 2 (PC), 3 (PC), 4(LC), 8(TE), 11(LC), 12(TE), and 15(LC) have no recognizable homology to any BAC contigs. If the BACs overlap, as the data suggests, these genes may be absent from the *Gal-m* haplotype and may be contributors to the gametophytic incompatibility phenotype. Alternatively, they may be found elsewhere in the genome.

Alignment information was used to predict a BAC order as seen in Figure 2.7. Our data suggests that BACs overlap to cover the entire region of interest. We hypothesize the following BAC arrangement: BAC 1, 2, 3, and 4 and BAC 3 falls within BAC 2.

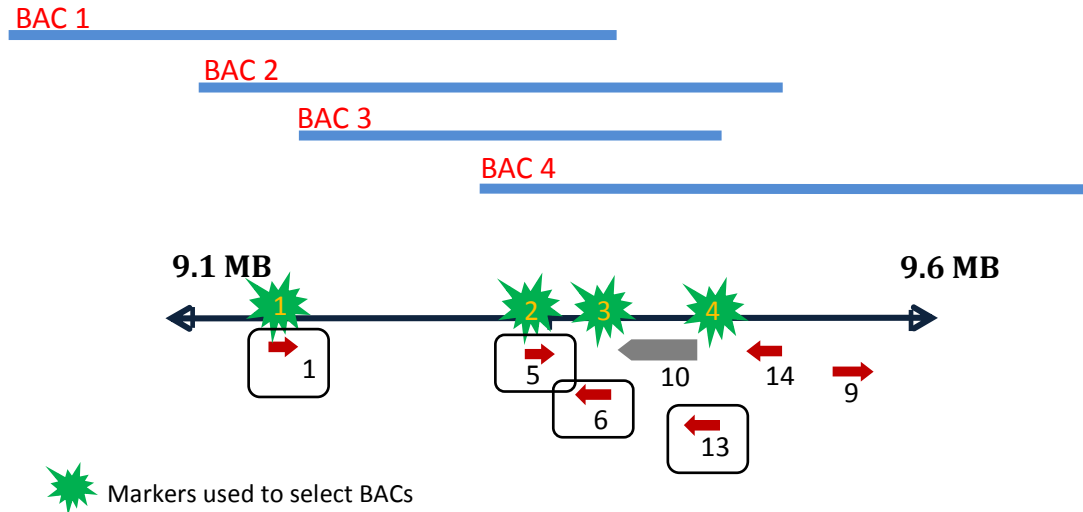

Figure 2.7. Hypothesized arrangement of BAC sequences and presence of B73 predicted genes in the *Gal-m* haplotype. Boxed arrows indicate genes where BAC markers originated.

Figure 2.7 illustrates the contig alignment data with the predicted genes in the B73 genome. Interestingly, gene 9 (GRMZM2G027021) aligns to only BAC 4. This result suggests the gene is found in the right most boundary of the region of interest, possibly due to reorganization of the *Gal-m* haplotype. Furthermore, marker sequence 1 and gene 1 (AC184772.3) are found in BAC 1, 2, and 4. If the predicted BAC order is correct, this result suggests that gene AC184772.3 is either duplicated within the region or the gene is found downstream of its predicted location in B73. Gene 13 (GRMZM2G039983), previously annotated as a putative causative gene by Liu et al. (2014), was also identified in our BAC sequences. It is highlighted in Table 2.9.

The region of interest originally identified by Liu et al. (2014) was determined using the B73 version 2 reference genome. We sought to determine if the region remained identical in the current, B73 version 3 genome. The region identified in the version 2 genome was between markers dCS1 and ID7 from

9,491,422 to 9,591,946 bp. The version 2 region contained genes GRMZM2G027021, AC204382.3\_FG010, and GRMZM2G039983. We could not find marker dCS1 (as published: TCTGTGGAGCTTTGATAAGC) in either version 2 or version 3; however, we could find the following sequence: TCTGTGGAGCTTTGATTGC. Using the identified sequence and the ID7 marker sequence, we identified the region of interest in the B73 version 3 genome to be from 9,496,453 to 9,596,169 bp on chromosome 4. The region contains genes GRMZM2G027021, GRMZM2G027368, and AC204382.3\_FG010. The putative gene identified by Liu et al. (2014) is no longer present in the region of interest.

BAC 2 assembled contigs from our research appeared to span the approximately 100 kb region of interest. To identify sequence differences between the BAC sequences and the B73 reference genome, BAC 2 assembled contigs were aligned to the region. A total of 664 contigs aligned to the 100 kb region. A total of 32 contigs covered the region with a total length of 26,696 bp. The alignment suggests no coverage in some parts of the region. Lack of coverage could be due to 1) large sequence deletions in the BAC sequences resulting in a region that is smaller than that found in B73 or 2) reads that remained unassembled could fill in regions with no coverage.

We next determined the presence of polymorphisms in each gene alignment. Table 2.10 describes insertions and deletions found within the gene alignments (see appendix for additional information on alignments). Polymorphisms led to missense mutations, frameshift mutations, and premature stop codons in the protein sequences. Closer observation of GRMZM2G027021 alignment with BAC

sequence reveals possible transposon activity. A deletion starting at bp 13,125 flanked by inverted terminal repeats are suggestive structures of the Ac/Ds transposon system. Such observed changes in predicted protein structure may lead to altered function which may underlie the causative polymorphisms of the gametophytic cross-incompatibility system. The gene is also protein coding found both in the version 2 and version 3 100 kb B73 region of interest. Genes within the identified region in B73 have yet to be annotated. Therefore, we can conclude that we did find sequence polymorphism in the BAC sequences; however the extent of those polymorphisms cannot yet be determined.

**AC184772.3****GRMZM5G817995****GRMZM2G419836****GRMZM2G027021****GRMZM2G039983****GRMZM2G039971**

Figure 2.8. Contig alignment to predicted genes in region of interest.



Table 2.10. Polymorphisms between B73 and BAC de novo assembled contigs.

Gene #	Gene ID	Total bp inserted	Total bp deleted	Change in protein length (aa)	Impact on translated product
1	AC184772.3	8	13	-1	Missense Frameshift
5	GRMZM5G817995	0	0	0	Missense
6	GRMZM2G419836	7	278	+165	Missense Nonsense Frameshift
9	GRMZM2G027021	176	7,791	+869	Missense Nonsense Frameshift
13	GRMZM2G039983	2,227	13	+737	Missense Nonsense Frameshift
14	GRMZM2G039971	1	1	0	Missense

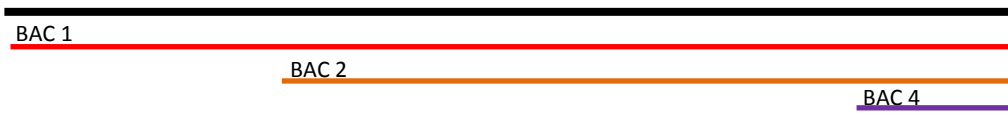
We next determined if the assembled contigs contained predicted genes not present in the B73 genome. Based on previous observations that BAC 2 falls within the region of interest and overlaps with the other BACs, and that BAC 1 and 4 likely extend out of the region of interest, it was concluded that BAC 2 would be the best BAC to analyze in order to find predicted genes not present in B73. BAC gene prediction was performed only on contigs 5kb and larger due to the large number of small contigs. BAC 2 was assembled into 984 contigs shorter than 5 kb. Predicted genes found in BAC2 can be seen in Table 2.11.

Gene prediction on BAC 2 contigs yielded 12 predicted genes. Predicted gene 1 from contig AP2\_c38 is found to overlap with the B73 predicted gene 6 (GRMZM2G419836). The predicted gene from AP2\_c38 is 3,011 bp smaller than the gene model found in B73. Mutations within AP2\_c38 alters the protein sequence.

Therefore, the protein structure found in BAC2 is not identical to the gene in B73. The remaining eleven out of the 12 predicted genes in BAC 2 contigs 5 kb and longer, were not present in B73, suggesting that the *Gal-m* haplotype contains unique genes not found in the reference genome.

The six remaining genes shared between B73 and the *Gal-m* haplotype are identified in contigs of approximately 500 to 5,000 bp in length. The predicted genes from the BAC 2 contigs 5 kb and greater were then blasted to the non-redundant nucleotide database using the NCBI web browser. Top blast outcomes can be seen in Table 2.12.

Table 2.11. Gene prediction of BAC 2 assembled contigs 5 kb and longer.

<b>Contig</b>	<b>Predicted genes</b>	<b>Predicted exons</b>	<b>Genes previously annotated in B73</b>
AP2_c38	2	3	1 of 2
AP2_rep_c126	2	3	no
AP2_rep_c137	1	1	no
AP2_rep_c138	2	5	no
AP2_rep_c134	0	0	no
AP1_c1	1	2	no
AP2_c5	2	8	no
AP2_c23	1	2	no
AP2_c53	1	6	no
AP2_rep_c142	0	0	yes

Results suggest that the BAC 2 contigs share homology with regions of chromosome 5. Interestingly, *Ga2*, an independent gametophytic cross-incompatibility system, is found on the long arm of chromosome 5. It may be possible that the *Gal-m* haplotype shares sequence similarities to the *Ga2* system. Similar to *Gal*, *Ga2* possesses

both a *-s* (strong) and *-m* (male) allele and has been shown to be analogous to *Gal* (Kermicle & Evans, 2010). It is possible that during the domestication processes, an ancestral gametophytic incompatibility locus was duplicated and the duplicates diverged to become the functionally distinct *Gal* and *Ga2* loci.

Several of the predicted genes found on BAC 2 contigs 5 kb and greater have homology to genes with functions that could play a role in pollen cross-incompatibility. Blast results for AP2\_c53 and AP2\_rep\_c137 suggest sequence homology to transcription factors. AP2\_rep\_c142 shows similarity to a zinc finger. If truly present in the region of interest, transcription factors/zinc fingers could be responsible for regulating the transcription of genes necessary for pollen tube growth or hormone secretion. Altered gene expression could lead to unsuccessful pollinations. Additionally, our data suggests gene AC184772.3 is potentially duplicated in the region. The presence of a zinc finger domain could result in a dimer of the two proteins with function that contribute to the incompatibility system.

AP2\_rep\_c134 shows sequence similarities to an Etr2-like ethylene-receptor protein. Ethylene receptors have been shown to be responsible for plant growth and development. Disrupted hormone levels could potentially result in arrested pollen tube growth as well as other imbalances in the silks.

AP2\_rep\_c142 also shows sequence homology to a repressor of a protein kinase-like protein. The roles of kinases in gametophytic self-incompatibility systems in *Brassica* have been well documented. Proteins expressed by the male and female tissues interact, leading to phosphorylation of a kinase domain that ultimately inhibits pollen

tube growth (Takasaki et al., 2000). It could be possible that kinases play a similar role in the inhibition of pollen tube growth in the gametophytic cross-incompatibility system.

Assembled contig AP2\_rep\_c126 demonstrated no homology to any known nucleotide sequences in the non-redundant database, despite gene prediction revealing two predicted genes in the contig sequence. It is possible that we discovered novel genes that have not been previously annotated in the maize genome. It could also be possible that we discovered genes unique to maize. Genes that are unique to a particular species are referred to as orphan genes. Orphan genes are thought to make up 0.5% to 8% of eukaryotic genomes (Li & Wurtele, 2015). It is hypothesized that the creation of orphan genes may be driven by genome duplication and rearrangements (Tautz & Domazet\_los0, 2011), both of which our results suggest may have occurred in the *Gal-m* haplotype. Only through further experimentation did Li and Wurtele (2015) determine the function of the orphan gene Qua-Quine-Starch (QQS) after primary sequence comparison identified no sequence homolog. It may be possible that an orphan gene is responsible for the male function in the gametophytic cross-incompatibility system. This may account for some of the difficulties in identifying the causative gene.

Table 2.12 BAC 2 contigs 5 kb and longer blasted to non-redundant nucleotide database.

Contigs	Length (bp)	e-value	Query coverage (bp)	Percent identity	Description	NCBI accession	Overlap w/ predicted gene
AP2_c38	25,649	0.0	16014-25362	86	<i>Zea mays</i> BAC clone from chr 7	AC229875.2	
			16021-25366	86	<i>Zea mays</i> BAC clone from chr 10	AC231756.2	
			16012-25364	84	<i>Zea mays</i> BAC clone from chr 9	AC229877.2	
			16012-25363	82	<i>Zea mays</i> BAC clone ZMMBBb-37E5	AC165179.2	
			16764-25362	82	<i>Zea mays</i> BAC clone from chr 5	AC203284.4	
			18321-25362	84	<i>Zea mays</i> retrotransposon Cinful-1	AF049110.1	yes
			18321-25363	84	<i>Zea mays</i> alcohol dehydrogenase 1 genes	AF123535.1	yes
			20203-24899	88	<i>Zea mays</i> BAC clone from chr 5	AC203071.4	
			20393-25362	86	<i>Zea mays</i> BAC clone from chr 5	AC196774.5	
			20043-25362	84	<i>Zea mays</i> cultivar B73 clone genomic sequence; identified as flowering time locus on chr 10	GU142949.1	
			20393-25363	86	Genomic sequence for <i>Zea mays</i> BAC clone ZMMBBb0448F23	AC160211.1	
			20551-24898	88	<i>Zea mays</i> putative transposase	AF466646.1	
			20393-25362	85	<i>Zea mays</i> putative growth-regulating factor 1	AY530951.1	
16012-20603	85	Contiguous genomic DNA; 19-KDA-zein family from <i>Zea mays</i>	AF546188.1	yes			
AP2_rep_c126	17,493	0.0	13830-16660	86	<i>Zea mays</i> clone FS2 19 chr B	EF190061.1	
			13830-15322	88	<i>Zea mays</i> clone from chr 6	AC226723.4	
AP2_rep_c137	14,619	0.0	10536-14616	89	<i>Zea mays</i> BAC clone from chr 5	AC196008.3	
			10536-14616	89	<i>Zea mays</i> BAC clone from chr 5	AC204225.4	
			10620-14618	85	<i>Zea mays</i> BAC clone from chr 5	AC201762.5	
			10620-14618	85	<i>Zea mays</i> BAC clone from chr 5	AC215174.5	
			10749-14563	85	<i>Zea mays</i> clone ZMMBBb-125C19	AC165173.2	
			11442-14609	85	<i>Zea mays</i> BAC clone from chr 5	AC196084.4	
			11442-14610	85	<i>Zea mays</i> BAC clone from chr 5	AC194844.5	
			11514-14610	85	<i>Zea mays</i> BAC clone from chr 5	AC210260.5	

Table 2.12 continued

			11805-14615	87	<i>Zea mays</i> m19 gene for putative MADS-domain transcription factor allele ZMM19	AJ850298.1	
AP2_rep_c138	12,648				Blast hits did not meet criteria		
AP2_rep_c134	12,298	0.0	8317-12186	83	<i>Zea mays</i> clone BACs ZMMBBb0345O22, ZMMBBc0294D02, ZMMBBb0103L15, ZMMBBb0622H01, and ZMMBBb0335C07	EF517600.2	
			1519-4106	88	<i>Zea mays</i> clone FS2 19 chr B	EF190061.1	
			1518-4119	88	<i>Zea mays</i> BAC clone from chr 6	AC226723.4	
			2666-4121	89	<i>Zea mays</i> B73 Etr2-like ethylene receptor (ETR61) pseudogene	AY359583.1	
			2666-4121	89	<i>Zea mays</i> full-length cDNA clone ZM Bf0095N09 mRNA	BT084267.2	
AP1_c1	8,315	0.0	1-2098	93	<i>Zea mays</i> BAC clone form chr 10	AC226721.2	
			17-2087	91	<i>Zea mays</i> chromosome 4 seq AGI.478 genomic sequence	GQ845080.1	
			2986-4472	96	PREDICTED: <i>Zea mays</i> uncharacterized protein	XM_008654301.1	yes
			2976-4472	95	<i>Zea mays</i> hypothetical protein mRNA	EU956244.1	yes
			720-1984	97	<i>Zea mays</i> full-length CDNA clone	BT069767.1	
			720-1982	96	<i>Zea mays</i> full-length cDNA clone	BT083566.2	
			1360-3070	89	<i>Zea mays</i> chloroplast phytoene synthase gene	AY455286.1	
			720-2002	94	<i>Zea mays</i> clone hypothetical protein mRNA	EU973310.1	
			1360-2096	94	<i>Zea mays</i> cultivar inbred line B73 teosinte glume architecture 1	AY883559.2	
AP2_c5	8,239	0.0	7240-7861	100	<i>Zea mays</i> uncharacterized LOC100501595	NM_001196280.1	yes
			6849-7936	99	<i>Zea mays</i> clone mRNA sequence	EU966398.1	yes



Table 2.12 continued

			1023-5645	85	<i>Zea mays</i> cultivar B73 locus 9009	AY664415.1	yes
			1023-5645	85	<i>Zea mays</i> cultivar Mo17 locus 9009	AY664419.1	yes
			1015-4909	85	<i>Zea mays</i> BAC clone from chr 5	AC204937.4	yes
AP2_rep_c142	5,430	0.0	1361-3575	88	PREDICTED: <i>Zea mays</i> zinc finger	XM_008676910.1	
			1361-3578	88	PREDICTED: <i>Zea mays</i> 52 kDa repressor for the inhibitor of the protein kinase-like	XM_008679685.1	
			1566-3575	88	PREDICTED: <i>Zea mays</i> zinc finger MYM-type protein 1-like	XM_008676911.1	
			1361-2842	88	PREDICTED: <i>Chrysemys picta bellii</i> zinc finger MYM-type protein 6-like	XM_008178212.1	
			2183-3413	89	PREDICTED: <i>Caprimulqua carolinensis</i> zinc finger MYM-type protein 1-like	XM_010163805.1	
			1361-2478	85	<i>Zea mays</i> CYP71C1 gene for cytochrome P-450	X81828.1	



## Conclusions

The BAC assembly project concluded with assembled contigs from each BAC file. We were successful in our attempt to compare assembled sequence with the B73 reference genome to characterize entire gene insertions and deletions and gene polymorphisms. In this research, we present two assembly methods and resulting conclusions from each.

Maize has many repetitive regions. Our BAC assembly data are consistent with this. We believe the repetitive nature of the region of interest, as well as substantial sequence variation between our BAC sequences and the B73 reference genome, resulted in an inefficient comparative genome assembly method. Because of this genomic structure, a de novo assembly of the region of interest worked better than first assembling reads that mapped to the B73 reference genome. De novo assembly of individual BACs and removal of residual contaminants resulted in the creation of 2,820 contigs. Contig breaks are suggestive of repetitive regions that remained unassembled. Additional arrangement and connection of contigs is required.

The de novo assembly of BAC sequences in our research successfully identified six predicted genes and one transposable element from the B73 genome. Gene model alignments showed polymorphisms that could lead to altered protein structure in BAC 2 contigs. The lack of annotated genes in the region and significant sequence variation made the identification of causative polymorphisms in the region challenging. Our results do suggest noncolinearity between the BAC sequences and the B73 reference genome. Six predicted genes and two transposable elements from the region of interest in B73 were not found within the *Gal-m* haplotype and therefore appear to be absent

from the region. Gene alignments support both theories that gene insertion/deletions and/or gene polymorphisms may underlie the male function in this system. At this point, we cannot definitively rule out either hypothesis.

We demonstrate clear BAC alignment with the gene GRMZM2G039983, predicted by Liu et al. (2014) to have a possible role in gametophytic cross-incompatibility. This gene has five gene insertion sites and multiple polymorphisms that resulted in a modified protein structure. Our results of a modified GRMZM2G039983 gene sequence are consistent with past conclusions that the gene may play a role in the incompatibility system. Using the current B73 v3 genome, we determine that the region of interest identified by Liu et al. (2004) is smaller than originally documented. Furthermore, we found that the putative gene identified (GRMZM2G039983) is no longer in the region. Published markers were used to identify genes 9, 10, and 11 to now be putative genes in the region of interest. Gene GRMZM2G027021 is a protein coding gene found in both the version 2 and version 3 region of interest. We also found possible transposable element activity in the gene sequence in our BAC sequences. We identify GRMZM2G027021 as a gene of high interest for causation of the male factor.

Gene prediction on BAC 2 assembled contigs of 5 kb and longer from the *Gal-m* haplotype yielded a total of 11 predicted genes not present in B73. BLAST results from the same BAC 2 contigs of 5 kb and longer suggest sequence homology on chromosome 5 and other conserved domains.

### **Significance**

The mechanism underlying gametophytic cross-incompatibility in maize has remained a mystery since its first identification in 1902 by Correns. Numerous

research studies have been performed and much knowledge has been contributed to the field; however, many integral questions about the system remain unresolved. Interest in using the gametophytic cross-incompatibility system as a biological barrier to prevent unwanted pollination of maize has increased. Increased knowledge of the system has economic advantages. The utilization of the gametophytic cross-incompatibility system may have benefits in organic and specialty maize production. Effective isolation of transgenes from certain maize systems would benefit producers of both market types. The use of the gametophytic cross-incompatibility system as a means to control the flow of transgenes could possibly prevent future allegations between farmers and biotechnology companies producing transgenic maize. Increased efficiency and ease of isolation could also result in a decreased maize price for consumers.

The ability to easily sequence DNA, has allowed for characterization of the region on the basepair level. This project marks the first attempt, to our knowledge, to sequence and annotate the 9.1 to 9.6 Mbp region from a *Gal-m* haplotype.

### **Recommendation for Future Research**

The next step required to move this project forward is to determine overlap of contigs across BAC files. Contigs must be correctly ordered and assembled into a scaffold sequence spanning the region of interest. PCR primers can be created with the aim of linking assembled contigs. Purified PCR product can be sequenced and used to fill in sequence gaps between contigs. Upon completion of a consensus sequence, gene prediction and gene annotation can be performed on the entire consensus sequence. Gene prediction on a sequence that covers the entire region of interest will give a more accurate estimation of novel genes. A better understanding of the sequence homology between the

region of interest and chromosome 5 (potentially *Ga2*) might shed light on genome arrangement and interaction.

PacBio sequencing may also greatly assist the assembly process. PacBio reads are much longer than reads from any other current sequencing technology, with a median length of 2,200 bp. PacBio reads could successfully span repetitive regions that are challenging to assemble with shorter reads. Additionally, PacBio reads and the Miseq reads used in this experiment could be used in a hybrid assembly with the PacBio reads. The presence of the shorter Miseq reads coupled with longer reads have been shown to offset the inherent sequencing error present with longer sequence reads and could potentially lead to a much improved assembly (Koren et al., 2012).

Further experiments could be done to assess involvement of predicted genes in the gametophytic cross-incompatibility region. The CRISPR-Cas 9 system could be used to knock out genes of interest and determine their role. Additionally, candidate genes could be transformed into a *gal* haplotype and the outcome observed. Due to the smaller, simpler genome of *Arabidopsis*, incorporating the genes into *Arabidopsis* might be a valuable experiment.

RNA-seq work could also bring a greater understanding to the gametophytic cross-incompatibility system. Expression data of compatible versus incompatible reactions at different time points in pollen tube growth could be collected. The RNA-seq reads could then be aligned to the region of interest and differentially expressed genes in the region (including the predicted novel genes) could be determined. Mapping RNA-seq reads to the genome could also be beneficial in annotating genes found in the region.

## References

- Altschul, S., Gish, W., Miller, W., Myers, E., & Lipman, D. (1990). Basic local alignment search tool. *Journal of Molecular Biology*, *215*, 403-410.
- Ashman RB. (1975). Modification of cross sterility in maize. *J Hered.* 66:5–9.
- Birnboim, H., & Doly, J. (1979). A rapid alkaline extraction procedure for screening recombinant plasmid DNA. *Nucleic Acids Research*, *7*(9), 1513-1523.
- Bloom, J. C., & Holland, J. B. (2011). Genomic localization of the maize cross-incompatibility gene, Gametophyte factor 1 (ga1) (Vol. 56, pp. 379-387): Maydica.
- Chaisson, M., Brinza, D., & Pevzner, P. (2009). De novo fragment assembly with short mate-paired reads: Does the read length matter? *Cold Spring Harbor Laboratory Press*, *19*, 336-346.
- Chevreux, B., Wetter, T., & Suhai, S. (1999). Genome sequence assembly using trace signals and additional sequence information. *Computer Science and Biology: Proceedings of the German Conference on Bioinformatics*, *99*, 45-56.
- Core, N. J. I. B. SICKLE. UC Davis Genome Center Institution: GitHub.
- Hall, T. (1997). BioEdit (Version 7.2.5).
- Julian, P., Allen, J., Christensen, M., Davis, P., Falin, L., Grabmueller, C., et al. (2014). Ensembl genomes 2013: Scaling up access to genome-wide data. *Nucleic Acids Research*, *42*(D1), D546-D552.
- Koren, S., Schatz, M., Walenz, B., Martin, J., Howard, J., Ganapathy, G., E, et al. (2013). Hybrid error correction and de novo assembly of single-molecule sequencing reads. *Nature Biotechnology* *30*(7), 693-700.

- Li, H., & Durbin, R. (2009). Fast and accurate short read alignment with burrow-wheeler transform. *Bioinformatics*, *25*, 1754-1760.
- Li, L., & Wurtele, E. (2014). The QQS orphan gene of Arabidopsis modulates carbon and nitrogen allocation in soybean. *Plant Biotechnology*, *13*(2), 177-187.
- Liu, X., Sun, H., Wu, P., Tian, Y., Cui, D., Xu, C., et al. (2014). Fine mapping of maize cross-incompatibility locus gametophytic factor 1 (ga1) using a homogeneous population. *Crop Science*, *54*, 1-9.
- Mi, H., Muruganujan, A., Gaudet, P., Lewis, S., & Thomas, P. (2010). PANTHER version 7: Improved phylogenetic trees, orthologs, and collaboration with the gene ontology consortium. *Nucleic Acids Research*, *38*, 204-210.
- Microsoft. (2010). Microsoft Excel. Redmond, Washington: Microsoft.
- Monaco, M., Sen, T., Dharmawardhana, P., Ren, L., Schaeffer, M., Naithani, S., et al. (2012). Maize metabolic network construction and transcriptome analysis. *Plant Genome*, *9*.
- Monaco, M., Sen, T., Dharmawardhana, P., Ren, L., Schaeffer, M., Naithani, S., et al. (2013). Maize Metabolic Network Construction and Transcriptome Analysis. MaizeGDB.
- Nelson OE. (1994). The gametophyte factors of maize. In: Freeling M, Walbot V, editors. *The maize handbook*. Berlin (Germany): Springer-Verlag. p. 496–503.
- Pearson, W., Wood, T., Zhang, Z., & Miller, W. (1997). Comparison of DNA sequences with protein sequences. *Genomics*, *46*(1), 24-36.
- Phillippy, A., Schatz, M., & Pop, M. (2008). Genome assembly forensics: finding the elusive mis-assembly. *Genomics Biology*, *9*(3), R55.

- Pop, M., Phillippy, A., Delcher, A., & Salzberg, S. (2004). Comparative genome assembly. *Briefings in Bioinformatics*, 5(3), 234-248.
- Robert, I., Stead, A., Ockendon, D., & Dickinson, H. (1980). Pollen stigma interactions in *Brassica oleracea*. *Theoretical and Applied Genetics*, 58, 241-246.
- Salamov, A., & Solovyev, V. (2000). Ab initio gene finding in Drosophila genomic DNA. *Genome Research*, 10(5), 16-522.
- Schmieder, R., & Edwards, R. (2011). Fast identification and removal of sequence contamination from genomic and metagenomic datasets. *PLoS ONE*, 6(3), e17288.
- Springer, N., Yin, J., Fu, Y., Ji, T., Yeh, C., Jia, Y., et al. (2009). Maize inbreds exhibit high levels of copy number variation (CNV) and presence/absence variation (PAV) in genome content. *PLOS Genetics*, 5(11), e1000734-e1000734.
- Takasaki, T., K. Hatakeyama, G. Suzuki, M. Watanabe, A. Isogai, and K. Hinata (2000). The S receptor kinase determines self-incompatibility in *Brassica stigma*. *Nature* 403 (6772): 913–6.
- Tautz, D., & Domazet-Lošo, T. (2011). The evolutionary origin of orphan genes. *Nature Reviews. Genetics*, 12(10), 692-702.
- Thompson, J., Higgins, D., & Gibson, T. (1994). CLUSTAL W: Improving the sensitivity of progressive multiple sequence alignment through sequence weighting, position specific gap penalties and weight matrix choice. *Nucleic Acids Research*, 22(22), 4673-4680.

Thomas, P., Campbell, M., Kejariwal, A., Mi, H., Karlak, B., Daverman, R., et al.

(2003). PANTHER: A library of protein families and subfamilies indexed by function. *Genome Research*, 13, 2129-2141.

Zhang, H., Liu, X., Zhang, Y. e., Jiang, C., Cui, D., Liu, H., et al. (2012). Genetic

analysis and fine mapping of the Ga1-s gene region conferring cross-

incompatibility in maize (Vol. 124, pp. 459-465): *Theoretical and Applied*

*Genetics*.



**CHAPTER THREE: ENCYCLOPEDIA OF FOOD GRAINS: MAIZE****CHAPTER**

A chapter published in the *Encyclopedia of Food Grains*

Marianne Emery and M. Paul Scott

Publication status: Pending

**Abstract**

Maize grain is an important source of food around the world. Maize variety, processing, and cultural tradition dictate use of maize in food. The maize plant is regarded as a model system in the scientific world. Due to relative ease of working with maize, a large body of research has been compiled by the maize community, most notably the assembly of the maize genome. Further, maize is continually being improved for a variety of marketable traits. This chapter gives an overview of breeding techniques and concerns that arise in regards to such maize plant modifications.

**Introduction**

*Zea mays*, more commonly referred to as maize, is a member of the grass family *Poaceae*, or true grasses. Maize is thought to have originated 55-70 million years ago in what is now Central or South America and has since diversified into nearly 10,000 nondomestic relatives. Figure 3.1 shows a phylogenetic tree of grass species related to maize. There exists no direct ancestor for maize, however to date the closest relative to maize are the teosintes (Kiesselbach, 1949; Strable and Scanlon, 2013; Wilkes, 2004). Prehistoric selection has resulted in ears lacking seed cases called glumes and seeds that

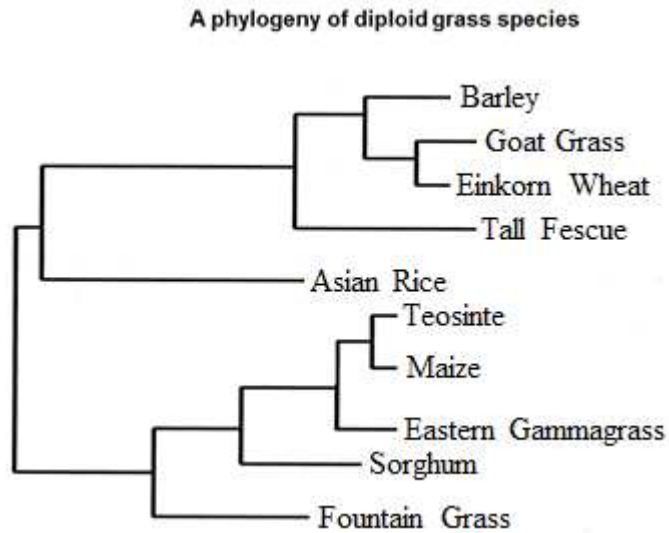

**Figure 3.1.** A phylogeny of diploid grass species.  
(Adapted from Gaut B S et al., 2000)

adhere to the cob until manual removal. These alterations limit the ability of maize to survive without human intervention. Maize is an annual plant with C4 metabolism making it very efficient at carbon fixation. It has the

greatest global production of any crop species. Nearly eight million tons were produced worldwide in 2013, accounting for 32% of total cereal production (FAO, 2014). The top three producers include the United States, China, and Brazil. Maize is grown on more area of the planet than any other crop and is grown on every continent except Antarctica. Over 300 countries in the world rely on maize for their food supply on a daily basis (FAO, 2014). The grain of maize is used for food, feed, and industrial products including biodegradable foams, plastics, and adhesives. Additionally, maize stover, the leaves and stalk of the maize plant, is used for forage, biofuel production, and chemical production.

### **Maize Reproduction**

Maize is a monoecious plant, meaning it has both male and female reproductive organs on the same plant. Flowers mature after approximately 60-70 days of vegetative plant growth. Male staminate flowers develop into tassels and are found on the

uppermost tip of the main stem. Female pistillate flowers are found in one or more ears located at nodes along of the stem. Typical maize varieties are diploid, containing two sets of 10 chromosomes. Copious amounts of pollen (up to one billion grains per plant) are shed from anthers and dispersed by air currents. While the majority of the pollen falls close to the plant, a small portion of the pollen can be carried great distances on air currents. Industry standards typically consider plants separated by a distance of 660 feet to be reproductively isolated. Fertilization occurs by the process of “double fertilization” common to angiosperm species. A pollen grain carrying two nuclei lands on a silk and germinates to produce a pollen tube. The pollen tube grows down the length of the silk until it reaches the embryo sac where it ruptures releasing the two sperm nuclei. The first sperm cell fuses with the egg cell, to produce the embryo, the organ that ultimately develops into the next generation plant. The second sperm cell fuses with the central cell of the embryo sac giving rise to the endosperm, the storage tissue that nourishes the developing seedling until it is capable of living independently. Grain fill to maturity takes about 40 days (Kiesselbach, 1949; Strable and Scanlon, 2013).

### **Maize Kernel Composition**

The mature maize kernel is referred to as a caryopsis and is not a true seed but rather a one-seeded fruit (Keisselbach, 1949; Rooney et al, 2004). Kernels are composed of four organs: the pericarp, embryo, endosperm, and pedicel (Keisselbach, 1949). Physical properties, such as hardness, shape, size, color and composition vary among maize varieties.

The main organs of a maize kernel are shown in Figure 3.2. The outer layer of the kernel is the pericarp and encloses the kernel for protection. The endosperm

comprises the majority of the kernel's inner contents. The endosperm itself is composed of four tissue types: the aleurone (outer) layer, the starchy endosperm, the basal endosperm transfer layer (BETL), and the embryo-surrounding region (ESR) (Scanlon and Takacs, 2009). The endosperm provides nutrients in the form of sugars and amino acids to the growing embryo. The embryo is composed of the following: the scutellum (the monocotyledon that absorbs nutrients during germination), the coleoptile (protective sheath of the emerging shoot), the plumule (young plant), the radicle (primary root), and the coleorhizae (protective sheath of emerging root) (Scanlon and Takacs, 2009; Rooney et al., 2004). The tip cap serves to attach the kernel to the cob and protect the kernel.

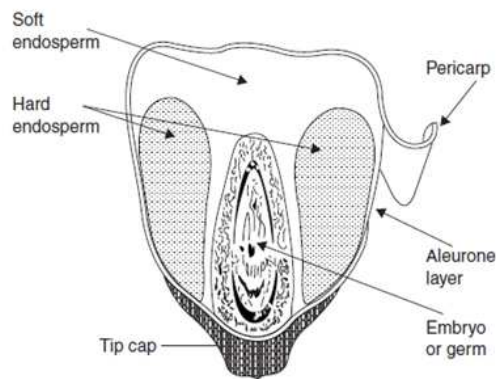

**Figure 3.2.** The mature maize kernel, showing component parts.  
(Encyclopedia of Grain Science)

In terms of nutritive composition, the kernel can be further classified into five main components. The typical Number 2 Yellow Dent maize kernel contains approximately 72% starch, 9.5% protein, 4.3% oil, 1.4% ash and 2.6% sugar (Watson, 2003).

### Starch

Starch is the most abundant component in maize kernels and serves as an efficient storage molecule for glucose. Starch accumulates in the form dense insoluble granules. It is composed of two main components: amylose and amylopectin. Amylose is predominantly a linear polymer composed of 1, 4 linked alpha D-glucan chains. In contrast, amylopectin is highly branched by alpha-1, 6 glycosidic bonds. Starch

biosynthesis requires the coordinated activities of a myriad of enzymes, including starch synthases, starch branching enzymes, and starch debranching enzymes. Enzymatic activity within the kernel alters starch content and properties. Degree of branching and branch chain length are starch properties that can vary considerably among maize varieties (Campbell et al, 1994; Ji et al, 2003). Maturity also affects starch quality (Jennings et al, 2002; Pollak and Scott, 2005). Traits sought in a commercial setting include gel strength, viscosity, and thermal properties such as gelatinization. Maize starch provides four calories per gram.

Genetic mutations can confer altered starch phenotypes. Mutant alleles of *waxy1* (*wx1*) produce 100% amylopectin starch, which is useful as a thickening agent in foods. Mutation of the amylose extender gene (*ae*) leads to high amylose starch (HAS) (Vineyard and Bear, 1952) with a range of amylose values from 25-80%. HAS is known for its slow digestion in vivo. The *sugary-1* (*su1*) and *shrunk-2* (*sh2*) lead to kernel phenotypes that are sweeter than field corn, and are used to produce sweet corn varieties for canning and fresh consumption.

## Oil

Oil is the second most abundant component of maize kernels. Oil from a kernel of typical Corn Belt Maize, Number 2 Yellow Dent, contains approximately 62% linoleic, 25% oleic, 10% palmitic, 2% stearic and 1% linolenic acid; saturated fatty acids equate to approximately 12% of total lipid content (Pollak and Scott, 2005; Poneleit and Davis, 1972). The oil within the maize kernel provides nine calories per gram. Linoleic, linolenic, eicosapentaenoic, and docosahexaenoic fatty acids are shown to have a positive

correlation with cardiovascular health. A ratio of 6:1, linoleic to linolenic, is recommended (Wijendran and Hayes, 2004).

Similar to starch content and quality, studies demonstrate that exotic germplasm possesses extensive ranges of fatty acid composition (Jellum, 1970). Exotic lines are crossed to yield varieties with increased oil content. Oil content varies across inbred maize lines (Poneleit and Davis, 1972) and across varied environments. Total fatty acid composition varies throughout kernel development and ultimately increases as the kernel matures (Poneleit and Davis, 1972). Oil content is believed to be affected by a large number of loci (Dudley and Lambert, 1992) and is a highly heritable trait. Certain breeding schemes aim solely at increasing lipid content and/or quality (Hallauer, 2004). Duvick (2003) altered fatty acid content by introducing *Tripsacum* genes, a wild relative of maize, into various maize lines.

Fatty acid stability is directly correlated to saturation level. Linolenic is the least stable fatty acid, containing three points of unsaturation. Oleic fatty acids are much more stable and less prone to oxidation. Oleic fatty acids are mono-unsaturated. Once oxidation begins, it cannot be stopped or reversed and ultimately leads to rancidity.

### Protein

Protein is another vital component to the maize kernel. Seed proteins are divided into four classes: albumin, globulin, prolamin, and glutelins (Rooney et al, 2004). The major storage proteins in maize are prolamins, also referred to as zeins. Eighty percent of the stored protein in maize is found in the endosperm (Flint-Garcia et al., 2009). Because of the amino acid balance of zeins and their abundance in the endosperm, lysine, tryptophan, and methionine are typically at low levels in maize (Flint-Garcia et al., 2009).

Maize is therefore not a complete protein source and must be eaten with complementary protein sources to ensure requirements for the essential amino acids are met. Many countries rely on maize as their main food source; in turn essential amino acid deficiencies such as Kwashiorkor and pellagra frequently occur (Krivanek, 1949). Maize protein provides 4 calories per gram.

Research aims to increase the quality of protein in maize. First observed in 1920, the *opaque-2* (*o2*) mutation causes a decrease in the amount of zein content and thus a higher ratio of nonzein

proteins with increased levels of essential amino acids. (Krivanek, 1949; Mertz et al., 1964).

Unfortunately, this mutation results in reduced kernel hardness, yield, and

fungal and pest resistance (Krivnek, 1949; Vasal, 2000). To overcome this deficiency, modifier genes have been introduced into *o2* varieties that increase kernel hardness. The resulting maize is called Quality Protein Maize (QPM) and grown in many parts of the world where it has contributed to improved nutrition (Prasanna et al., 2001). In addition to *o2* mutants, *floury2* (*fl2*) mutants have shown to have improved amino acid balance (Nelson et al., 1965).

Less abundant components of the maize kernel include: fiber, minerals, vitamins, anthocyanins, and anti-nutrients.

Grade	Minimum Test, Weight/Bushel (lb)	Maximum Percent Allowed		
		Damaged Kernels		Broken Kernels and Foreign Material
		Heat-Damaged	Total	
U.S. 1	56.0	0.1	3.0	2.0
U.S. 2	54.0	0.2	5.0	3.0
U.S. 3	52.0	0.5	7.0	4.0
U.S. 4	49.0	1.0	10.0	5.0
U.S. 5	46.0	3.0	15.0	7.0

U.S. Sample Grade:  
 (a) Does not meet the requirements for grades U.S. No. 1,2,3,4, or 5; or  
 (b) Contains stones which have an aggregate weight in excess of 0.1 percent of the sample weight, 2 or more pieces of glass, 3 or more crotalaria seeds (*Crotalaria* spp.), 2 or more castor beans (*Ricinus communis* L.), 4 or more particles of an unknown foreign substance(s) or a commonly recognized harmful or toxic substance(s), 8 or more cockleburrs (*Xanthium* spp.) or similar seeds singly or in combination, or animal filth in excess of 0.20 percent in 1,000 grams; or  
 (c) Has a musty, sour, or commercially objectionable foreign odor; or  
 (d) Is heating or otherwise of distinctly low quality.

**Figure 3.3.** U.S. maize grading scale.  
(USDA, 2013)

## Maize in Food

Maize is a food ingredient that brings commonality to culinary cultures across the world. Cultural traditions and corn varieties dictate how maize is incorporated into a wide variety of foods. Main kernel components can be separated and processed into products such as corn starch for thickening and binding agents and corn oil for frying and baking; whole grain kernels are used in popped popcorn or ground into corn meal and used in breads, biscuits, and cereals. From enchiladas, tamales, totopos, tostaditas, and tortillas, virtually every Mexican dish uses maize. Maize porridges are seen across the world: referred to as puliszka and malderash in Hungary, posho in Africa, polenta in Europe, grits in the United States, and kpekple in Ghana. Maize meal can be ground and fermented into sora, a maize beer in Peru, or used to make hard alcohols such as whiskey and bourbon. Maize is truly a cross cultural food.

### Maize processing

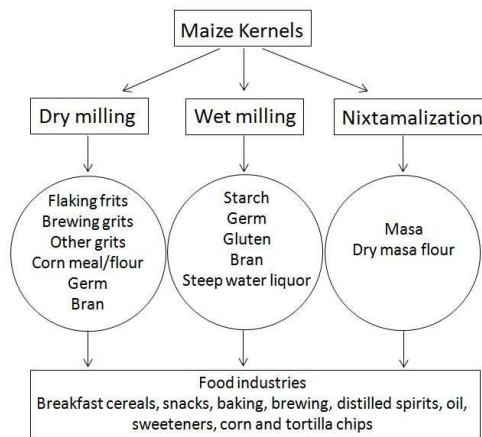

**Figure 3.4.** Maize food processing determines maize as food ingredient.

(Adapted from Encyclopedia of Grain Science)

Maize kernel quality and physical attributes determine its end use. The U.S. recognizes 5 grades of maize and three classes: yellow, white, and mixed maize (USDA, 2013). Food maize typically specifies number 1 grade yellow or



white dent corn (Figure 3.3). Additionally, the manner in which maize is processed is a vital component in its incorporation into foods (Figure 3.4).

Harder kernels are desirable for storage, shipping and handling; dry-milling calls for a kernel with a harder endosperm void of cracks (Rooney et al, 2004). Dry-milling is often used to produce baked goods, breakfast cereals, and ethanol (Orthoefer and Eastman, 2004). In the dry-milling process, tempering the grain is a vital first step. A hammer mill is then used to coarsely grind the maize kernels. Several steps of size and weight separation, in addition to regrinding, yield maize grits, flour, and fiber. The quality, content, and end use of the maize must be considered before entering the wet or dry milling process.

Maize kernels with a softer endosperm perform better in the wet-milling process (Orthoefer and Eastman, 2004). The wet-milling process includes steeping maize in a dilute sulfur dioxide solution to soften the kernel and separate it into its smaller components. The germ can be first removed and later processed for oil. The remaining components are ground and separated further into grits, flour, and fiber. Further processing yields corn gluten, meal, and starch. Maize starch and high fructose corn syrup are a main end-product of the wet milling process in the United States.

Nixamalization, dating back from 1200-1500 BC, is an ancient type of maize processing that includes rendering kernels into a paste to increase the bioavailable nutrients such as calcium and digestible iron (Orthoeffer and Eastman, 2004; Rooney et al, 2004). Kernels are steeped in a water/lime solution over heat and ground into masa, also known as maize dough that is used to produce tortillas, corn chips and other food products.

## Maize in Science

Maize is an important model organism in genetic research. It has several attributes that make it attractive for this purpose. It is a large plant and phenotypic analyses are easily done. Each plant produces an ear typically containing 100-400 kernels. It is broadly adapted and has tremendous genetic diversity. Maize has a moderately sized genome of approximately 2.5 gigabase pairs (Strable and Scanlon, 2013). A vast collection of mutant stocks have also been developed that assist in research; this has allowed for many genes to first be characterized molecularly in maize. Being a diploid species, genetic manipulation and analysis is less complex than in species with a higher ploidy level. Additionally, the large physical size of the maize chromosomes is a great benefit to cytogenetic researchers.

Research on maize has led to several key discoveries. Perhaps most notable is the discovery of transposons by

Barbara McClintock

(McClintock, 1950), for

which she was awarded the

Nobel Prize in Physiology or

Medicine in 1983.

Cytogenetic studies in maize

resulted in an understanding

of genetic recombination and

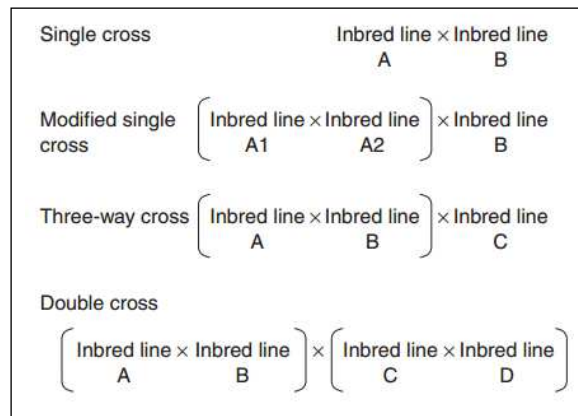

**Figure 3.5.** Types of hybrids grown commercially in North America.

(Encyclopedia of Grain Science)

enabled genetic mapping. The role of telomeres was determined in maize. Through collaborative efforts, it was one of the first crops to have its genome completely sequenced (Schnable et al., 2009).

### **Maize Breeding, Genetics, and Biotechnology**

#### Maize cultivar types

A cultivar is a plant variety that has been developed for a specific use. Several types of maize cultivars are grown including inbred lines, single-cross hybrids, double cross hybrids, and open pollinated varieties (Figure 3.5). Inbred lines are created by successive generations of self-pollination. The resulting plants are genetically homozygous and phenotypically homogeneous. Due to inbreeding depression, inbred lines have low yield and are not used for grain production. Their main purpose is in the production of hybrid seed. When two inbreds are cross pollinated, a single-cross hybrid results. Single-cross hybrids are genetically heterozygous and phenotypically uniform. Because of the difficulties of producing seed on inbred lines, several types of hybrids have been developed. An open pollinated variety is a population of plants that is genetically heterozygous and phenotypically non-uniform. As the name implies, seed of open pollinated varieties is produced by allowing natural pollination to occur in the population. Synthetic populations are derived from inter-mating several varieties and are frequently used in breeding programs to produce inbred lines.

Mechanized agriculture has led to a preference for hybrids because of their uniformity and high yields. The process of hybrid improvement and seed production has become highly industrialized. Industrial maize breeding has led to greatly increased

yields. Open pollinated varieties require much less infrastructure for seed production and genetic improvement and are often grown in developing countries.

### Hybrid maize breeding

Hybrid maize breeding allows breeders to capture and fix extremely productive genotypes by taking advantage of hybrid vigor. Productivity and vigor in maize plants is generally proportional to the degree of heterozygosity. Thus, inbred lines, although uniform and reproducible are usually poor agronomic purposes. Heterozygosity and performance can be restored by

crossing unrelated inbred lines

to make hybrids. Inbred lines

are classified into heterotic

groups according to their

ability to form productive

hybrids in combination with

other groups and their

suitability as a male or female

parent. For example, nearly all

inbreds used as females in

North American hybrids are in the Stiff Stalk heterotic group. Development and

maintenance of inbred lines and testing hybrid combinations requires a great deal of

infrastructure and expertise that is not available to most farmers or even small seed

companies and is therefore largely done by large seed companies.

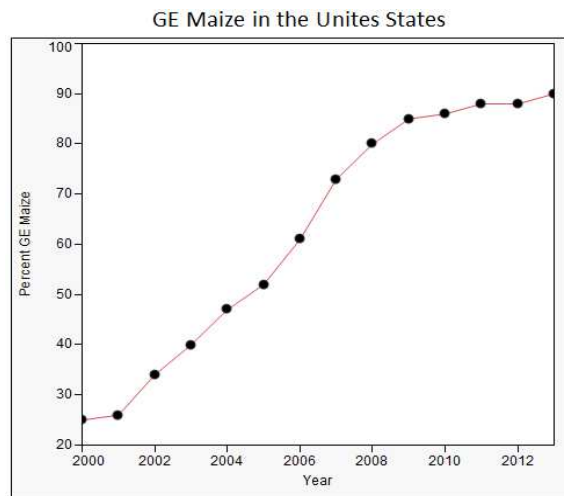

**Figure 3.6.** Percentage of all maize grown in the United States that is genetically engineered (GE). (USDA, 2014)

Uniformity is essential in efficient and profitable production of maize. Superior technology and machinery has assisted with such uniformity. Improved accuracy in the evaluation of cultivars has allowed for large genetic gains and the overall creation and advancement of superior maize inbreds. Superior farm equipment equipped with GPS and computer monitoring systems has led to optimal planting depth, density, and spacing and precise measurements of grain yield during harvest. In the future, precision agriculture will continue to increase productivity by optimizing inputs, such as corn variety and fertilizer amount, on a per land area basis.

### Maize biotechnology

Biotechnology is the ability to introduce genes from any source into the maize genome. Two types of traits derived from biotechnology methods are currently in commercial production: insect resistance and herbicide tolerance.

Insect resistant maize decreases the need of pesticide applications directly to the plant. The use of pesticides in the United States has been reduced 6% since 1996, a total of 172 million kilograms per year (Brookes and Barfoot, 2005). Fewer pounds of chemical are applied, benefiting the health of the environment and proving economically beneficial for the farmer. From 1996-2010, the income of US farmers increased a total of \$21.7 billion dollars; 23 percent of that profit was derived from 2010 alone (Brookes and Barfoot, 2005). The percentage of GE maize has increased almost 4 fold in 12 years (Figure 3.6.). The United States Department of Agriculture (USDA) Economic Research Service reports that *Bt* maize decreased the amount of insecticides per planted acres of *Bt* maize by 8% in the United States (Fernandez-Cornejo and Caswell, 2006). Herbicide tolerant maize is agreeable in environments of low to no-till agriculture. Minimal to no

tillage results in decreased fuel usage and reduction of greenhouse gas emissions, as well as less soil compaction and erosion. Additionally, crop residue left on top of the soil increases levels of organic carbon sequestration. Soil and water quality are increased due to decreasing soil erosion and nutrient loss (Committee on the impact of biotechnology on farm-level economic and sustainability and national research council, 2010; National Research Council, 2010).

Of the 159 million hectares of maize grown globally in 2012, 55.1 million hectares (35%) were biotech maize (Clive, 2012). Legislation regulating such crops varies among countries. The United States regulates genetically modified organisms (GMOs) based on the end product. Three groups with differing perspectives and expertise regulate genetically modified (GM) crops in the US: the US Environmental Protection Agency (EPA), the Food and Drug Administration (FDA), and the US Department of Agriculture (USDA). GM crops must be verified free from environmental and human toxins as well as foreign proteins deemed allergenic. The FDA policy established in 1992, considers the currently approved GM crops to be “substantially equivalent” to non-GM crops and deemed “Generally Recognized as Safe” under the Federal Food, Drug, and Cosmetic Act (FFDCA); therefore, foods made with approved GM varieties do not require pre-market approval (Tucker, 2011). Acceptance of GM maize by the consumer varies by country. The European Union (EU) regulates GM crops based on the process in which they are produced. The EU tends to be cautious of GM crop consumption. The British Press often refers to such crops as “Frankenstein Foods.” Protestors of third world countries have been known to destroy entire fields of GM crop despite starvation in the country. The major concerns over production of GM maize are

pollination of weedy species or non-GM maize by GM pollen resulting in undesirable transfer of the transgene (Snow, 2002) and the impact of transgenes on non-target species, particularly beneficial insects, and the development of insects resistant to the mode of action of the insecticidal transgenes in use. Researchers and regulatory agencies continue to develop new deployment strategies in an effort to minimize these risks.

## References

- Brookes, G., & Barfoot, P. (2005). GM crops: The global economic and environmental impact-the first nine years 1996-2004. *AgBioForum*, 8, 187-196.
- Campbell, M. R., White, P. J., & Pollak, L. M. (1994). Dosage effect at the sugary-2 locus on maize starch structure and function (Vol. 71, pp. 464-468): *Cereal Chemistry*.
- Corn Breeding: Types of Cultivars*. (2014, April 9).  
from <http://passel.unl.edu/pages/informationmodule.php?idinformationmodule=1099683867&topicorder=8&maxto=9&minto=1>(2014, April 9).
- Crawley, M. J., Brown, S. L., Hails, R. S., Kohn, D. D., & Rees, M. (2001). Transgenic Crops in Natural Habitats. *Nature*, 409.
- Dudley, J. W., & Lambert, R. J. (1992). Ninety generations of selection for oil and protein in maize (Vol. 37, pp. 1-7). *Maydica*.
- Duvick, D. (1996). Plant Breeding, an Evolutionary Concept (Vol. 36, pp. 539-548): *Crop Science*.
- Eckhoff, S. R. (2004). Wet Milling. In C. Wrigley, *Encyclopedia of Grain Science* (pp. 225-241): Elsevier.
- FAO. (2014). from <http://faostat3.fao.org/download/Q/QC/E> (2014, April 9).
- Flint-Garcia, S. A., Bodnar, A. L., & Scott, M. P. (2009). Wide variability in kernel composition, seed characteristics, and zein profiles among diverse maize inbreds, landraces, and teosinte (Vol. 119, pp. 1129-1142): *Theoretical and Applied Genetics*.



- Gaut, B. S., Le Thierry D'Ennequin, M., Peek, A. S., & Sawkins, M. C. (2000). Maize as a model for the evolution of plant nuclear genomes. *PNAS*(97), 7008-7015.
- Hallauer, A. R. (2004). Specialty Corns. In *Corn: Origin, History, Technology, and Production* (pp. 897-933). Hoboken, New Jersey: John Wiley & Sons.
- Hannah, L. C. (2005). Starch synthesis in the maize endosperm. *Maydica*, 50, 497-506.
- Jellum, M. D. (1970). Plant introductions of maize as a source of oil with unusual fatty acid composition (Vol. 18, pp. 365-370): *Journal of Agricultural and Food Chemistry*.
- Jennings, S., Myers, D., Johnson, L., & Pollak, L. M. (2002). Effects of maturity on corn starch properties (Vol. 79, pp. 703-706): *Cereal Chemistry*.
- Jeon, J., Ryoo, N., Hahn, T., Walia, H., & Nakamura, Y. (2010). Starch biosynthesis in cereal endosperm. *Plant Physiology and Biochemistry*, 48, 383-392.
- Kiesselbach, T. A. (1949). *The structure and reproduction of corn*. Lincoln, Nebraska: University of Nebraska.
- Lorenz, A., Scott, P., & Lamkey, K. (2008). Genetic Variation and Breeding Potential of Phytate and Inorganic Phosphorus in a Maize Population (Vol. 48, pp. 79-84): *Crop Science Society of America*.
- McClintock, B. (1950). The origin and behavior of mutable loci in maize. *Genetics*, 36, 344-355.
- Mertz, E. T., Bates, L. S., & Nelson, O. E. (1964). Mutant gene that changes protein composition and increases lysine content of maize endosperm (Vol. 145, pp. 279-280): *Science*.

- Nelson, O. E., Mertz, E. T., & Bates, L. S. (1965). Second mutant gene affecting the amino acid pattern of maize endosperm proteins. *Science*, *150*, 1469-1470.
- Orthoefer, F. T., & Eastman, J. (2004). Corn Processing and Products. In *Corn: Origin, History, Technology, and Production* (pp. 867-896). Hoboken, New Jersey: John Wiley & Sons.
- Pollak, L. M., & Scott, M. P. (2005). Breeding for Grain Quality Traits (Vol. 50, pp. 247-257): *Maydica*.
- Poneleit, C. G., & Davis, D. L. (1972). Fatty acid composition of oil during maize kernel development (Vol. 11, pp. 3421-3426).
- Prasanna S.K.V., B. M., Kassahun, B., & Singh, N. N. (2001). Quality protein maize. *Current Science*, *81*, 1308-1319.
- Rooney, L. W., McDonough, C. M., & Waniska, R. D. (2004). The Corn Kernel. In C. W. Smith, J. Betran & E. C. A. Runge (Eds.), *Corn: Origin, History, Technology, and Production* (pp. 273-303). Hoboken, New Jersey: John Wiley & Sons.
- Scanlon, M. J., & Takacs, E. M. (2009). Kernel Biology. In J. L. Bennetzen & S. C. Hake (Eds.), *Handbook of Maize*. New York, NY: Springer Science+Business Media.
- Serna-Saldivar, S. O. (2004). Foods from Maize. In C. Wrigley (Ed.), *Encyclopedia of Grain Science* (pp. 242-253): Elsevier.
- Snow, A. A. (2002). Transgenic crops: Why Gene Flow Matters. *Nature Biotechnology*, *20*, 542.

- Strable, J., & Scanion, M. (2013). Maize (*Zea mays*): A Model Organism for Basic and Applied Research in Plant Biology (pp. 1-9). Cold Spring Harbor Protocols: Cold Spring Harbor Laboratory Press.
- Tucker, J. (2011). *U.S. Regulation of Genetically Modified Crops*, 2014, from <http://www.fas.org/biosecurity/education/dualuse-agriculture/2.-agricultural-biotechnology/us-regulation-of-genetically-engineered-crops.html> (2014, April 10).
- USDA. (2014). *Adoption of genetically engineered crops in the U.S.*, 2014
- Vasal, S. K. (2000). High quality protein corn. In A. R. Hallauer (Ed.), *Specialty corns* (2 ed.). Boca Raton: CRC Press.
- Velu, V., Nagender, A., Prabhakara Rao, P. G., & Rao, D. G. (2006). Dry milling characteristics of microwave dried maize grains (Vol. 74, pp. 30-36): *Journal of Food Engineering*.
- Vineyard, M. L., & Bear, R. P. (1952). Amylose content (Vol. 26, pp. 5): *Maize Gen. Coop. Newsletter*.
- Vogel, K., & Burson, B. (2004). Chapter 3: Breeding and Genetics (pp. 51-94): American Society of Agronomy, Crop Science Society of America, Soil Science Society of America.
- Wijendran, V., & Hayes, K. C. (2004). Dietary n-6 and n-3 fatty acid balance and cardiovascular health. *Annual Review of Nutrition*, 24, 597-615.
- Wilkes, G. (2004). Corn, strange and marvelous: But is a definitive origin known? In W. C. Smith, J. Betran & E. C. A. Runge (Eds.), *Corn: Origin, History,*

*Technology, and Production* (pp. 3-64). Hoboken, New Jersey: John Wiley & Sons.

Wu, R., Lou, X.-Y., Ma, C.-X., Wang, X., Larkins, B. A., & Casella, G. (2002). An improved genetic model generates high-resolution mapping of QTL for protein quality in maize endosperm (Vol. 99, pp. 11281-11286): National Academy of Sciences of the United States of America

## APPENDIX: ADDITIONAL ALIGNMENT INFORMATION

## AC184772.3

```

      |...|...|...|...|...|...|...|...|...|...|...|...|
      1                                                                 70
AC184772.3 ATGCC TCCGC CCTTGCCCTC CCCCC-GGC AATCTCGCAT CGGCGCCCGC CCCAGCCCG TAGAGGTCGC
      |...|...|...|...|...|...|...|...|...|...|...|...|
      70                                                                 140
AC184772.3 ATCCGTCAGC CTCTTCCCA CCACGGTCCC CCCTTCCCA CCCACCGGAG ACCGCGCCCT TCCCCTTTC
      |...|...|...|...|...|...|...|...|...|...|...|...|
      141                                                                 210
AC184772.3 CCCACCGCGG CATGGCGTCG GCTTACCCAC CAGAGACTGA TTCCTCCAAC -----CC CATCTCAACC
      |...|...|...|...|...|...|...|...|...|...|...|...|
      211                                                                 280
AC184772.3 ATCTGCCCTC CTCAAGTTCC TCGAGCACAG GAGCAGGGGA GGGTTCCACC AGGCCGAGGC GCCATACCAG
      |...|...|...|...|...|...|...|...|...|...|...|...|
      281                                                                 350
AC184772.3 TCGCTCTCG CTGCACGTGT CGTCGCGTGG GCCTTTGACT TCAGCTTCTC CTTCTCCCC AGCCACCACC
      |...|...|...|...|...|...|...|...|...|...|...|...|
      351                                                                 420
AC184772.3 GTGTTGTTGG ACCTCGCACC ACGCGATCCC TTGCATCGCC GGTATGTCCA GATCCCACC ATCCCAATG
      |...|...|...|...|...|...|...|...|...|...|...|...|
      421                                                                 490
AC184772.3 AGCTCTGTC CTCCTCCGTC GTGTCGTACC AAGACGGTGT AGATCTAGAG CATTTCCTAG CACCGGATCT
      |...|...|...|...|...|...|...|...|...|...|...|...|
      491                                                                 560
AC184772.3 CAGAGAGGCA AAGGACAAGT CCGTGTCTA GATGATCTGT AGCCCTCCCG ATCGCCCTC GCTCTTGCC
      |...|...|...|...|...|...|...|...|...|...|...|...|
      561                                                                 630
AC184772.3 CCACGACGCG CCCGTGCCCA CACCCGATA CAGCTGTGTG GGGTTCTATG CGAGTGCAGG GCTGGTGC
      |...|...|...|...|...|...|...|...|...|...|...|...|
      631                                                                 700
AC184772.3 GAGGTGTGGG CGTCCGTCGA GGAGTTGAG GCCGTGGCG ACGGCGCCAC GCCCAACGCC GCGGTGTTCC
      |...|...|...|...|...|...|...|...|...|...|...|...|
      701                                                                 770
AC184772.3 GGCACGCCGT CATAGAGCTG GGCGTGAGGT CCCCAGTGG GGGAGGGGCC AGGCTCGACG TGCCCCAAG
      |...|...|...|...|...|...|...|...|...|...|...|...|
      771                                                                 840
AC184772.3 GAGGTGGCTC ACGGCAGCT TCAACCTCAC TAGCCGCTTC ACCCTCTTC TGACCCACGG CGCGTCATC
      |...|...|...|...|...|...|...|...|...|...|...|...|
      841
AC184772.3 ATCGGCTCCT AG
      ATCGGCTCCC AG

```

## GRMZM5G817995

```

      .....|.....| .....|.....| .....|.....| .....|.....| .....|.....|
GRMZM5G817995 1 ATGGTTTATT TGCTTCTCAA ATTGGTATTG CTTTGGCCAG TAGGGGCGGA GGGCCTGTTA 60
      ATGGTTTATT TGCTTCTCAA ATTGGTATTG CTTTGGCCAG TAGGGGCGGA GGGCCCGTTA

      .....|.....| .....|.....| .....|.....| .....|.....| .....|.....|
GRMZM5G817995 61 TGGCCAAGTA TAGCCACGC CATACTCAA CTCAGCCCAG TCGCAGCCTC CCTGCTAGTG 120
      TGGCCAAGTA TGGCCCGCGC CATACTCAA CTCGGCCCAG TCGCAGCCTC CCTGCTAGTG

      .....|.....| .....|.....| .....|.....| .....|.....| .....|.....|
GRMZM5G817995 121 CTCCCCTCT GTGGCCGCGC AACAGGCACA ACTGTAGTAT CGCAGGCGCA CAAGCGAGCC 180
      CTCCCCTCT GTGGCCACGC AACAGGCACA ACCGTAGTAC AGCAGGCACA CAAGCGAGCC

      .....|.....| .....|.....| .....|.....| .....|.....| .....|.....|
GRMZM5G817995 181 ATCTGCTCAT CGTTCCGTTT GCGACCGCCT CTGCCTGGCC GGCCGCAGC TGCCCGAGCA 240
      GCCTGCTCAT CGTTCCGTTT GCGACCGCCT CGCCTGGCT GGTCGCAGC TGCCCGAGCA

      .....|.....| .....|.....| .....|.....| .....|.....| .....|.....|
GRMZM5G817995 241 CGGCCGCGCG CTTGTGCCTT ACTGAGTCGC CGCCTCTCTG AAAGTTGCCT AAAGGGGGGG 300
      CGGCCACGCG CCCGTGCCTT ACTAAGTCGC CGCCTCTCTG AAAGTCGCCT AAAGGGGGGA

      ...
GRMZM5G817995 301 TGA
      TGA

```

## GRMZM2G419836

```

...|...|...|...|...|...|...|...|
 5      15      25      35      45      55
GRMZM2G419836 GCCGTGCGCC TCACATCTTC CCTCCGCCAG TCCGTTGACA CCCCCCCCC CCCCCCCCC
GCCGTGCGCC TCCATCTTC TC-----

...|...|...|...|...|...|...|...|
 65      75      85      95     105     115
GRMZM2G419836 CTCGGCCATC CACCGGAGAT GGGCGCCGCC GGCAAGCCTC CTCCCCTCGT CTGCTTCAAA
----- CACCGGAGAT GGGCGCCGCC GGCAAGCCTC CTCCCCTCGT CTGCTTCAAA

...|...|...|...|...|...|...|...|
125     135     145     155     165     175
GRMZM2G419836 TGGCCGTGGG GCCCTAATCC TATCCCATCG GCGAGCTCCA GCCCCAGCC CTGCGGGCAGC
TGGCCGTGGG GCCCTAATCC TATCCCATCG GCGAGCTCCA GC-----CC CTGCGGGCAGC

...|...|...|...|...|...|...|...|
185     195     205     215     225     235
GRMZM2G419836 CTCGAGCTCC CCTGGCTCTT CAAGTCCATC CGCACCCCTCG CGCAGGGCCT CCTCATCGCC
CTCGAGCTCC CCTGGCTCTT CAAGTCCATC CGCACCCCTCG CGCAGGGCCT CCTCATCGCC

...|...|...|...|...|...|...|...|
245     255     265     275     285     295
GRMZM2G419836 GGCGACATCC CCTCCCCCGC CTCTTCTCCC AGCGGAGGAG TAAGGGGCGT TCAGAGGCGC
GGCGACATCC CCTCCCCCGC CTCTTCTCCC AGCGGAGGAG TAAGGGGCGT TCAGAGGCGC

...|...|...|...|...|...|...|...|
305     315     325     335     345     355
GRMZM2G419836 ACGGGTGCCG CGGTGGTGGA GGTGGACCGC GGGGACGCTG AACAGCGCGC CCTGGCGGCA
ACGGGTGCCG CGGTGGTGGA GGTGGACCGC GGGGACGCTG AACAGCGCGC CCTGGCGGCA

...|...|...|...|...|...|...|...|
365     375     385     395     405     415
GRMZM2G419836 TCGCTCGCGA GCGGGAGGCC CGCCACGGTG CTGGAGTTCT ACTCCCCGCG CTGCCGCCTG
TCGCTCGCGA GCGGGAGGCC CGCCACGGTG CTGGAGTTCT ACTCCCCGCG CTGCCGCCTG

...|...|...|...|...|...|...|...|
425     435     445     455     465     475
GRMZM2G419836 TGCGCCTCTT TGCAGGGCCT CGTTCGCGAG CTCCAAGACG GTGCCAGTGG CTCCGCCAGT
TGCGCCTCTC TGCAGGGCCT CGTTCGCGAG CTCCAAGACG GTGCCAGTGG CTCCGCCAGT

...|...|...|...|...|...|...|...|
485     495     505     515     525     535
GRMZM2G419836 TTCGTGCTCG CTGACGCCGA GGACGACCGG TGGCTCCCCG AGGTATGTCG CCCCTTGCCA
TTCGTGCTCG CTGACGCCGA GGACGACCGG TGGCTCCCCG AGGTATGTCG CCCCTTGCCA

...|...|...|...|...|...|...|...|
545     555     565     575     585     595
GRMZM2G419836 TCTTCTGGGA AAATTCAGAC AATTTGTCAG ATTTGTGATG CCGATTTGGG TGCTCTGTTC
TCTTCTGGGA AAATTCAGAC AATTTGTCAG ATTTGTGATG CCGATTTGGG TGCTCTGTTC

...|...|...|...|...|...|...|...|
605     615     625     635     645     655
GRMZM2G419836 TCTACAGAGG AAAGATAAAC CTTTGCAATA GTGATTTAGC CACATAGGTC TTCTTCTGTT
TCTACAGAGG AAAGATAAAC CTTTGCAATA GTGATTTAGC CACATAGGTC TTCTTCTGTT

...|...|...|...|...|...|...|...|
665     675     685     695     705     715
GRMZM2G419836 AATTGCCTTT GCTATGGTAA TTTAGCCATA TTGGTCATGT TCTGATCAAT TTATGATGAC
AATTGCCTTT GCTATGGTAA TTTAGCCATA TTGGTCATGT TCTGATCAAT TTATGATGAC

...|...|...|...|...|...|...|...|
725     735     745     755     765     775
GRMZM2G419836 TAGATGCTAT GTTGCACTTT GATGATGAGA AATTGATGAT TAGAAAATCA GTAGGTTCCA
TAGATGCTAT GTTGCACTTT GATGATGAGA AATTGATGAT TAGAAAATCA GTAGGTTCCA

```

```

.....|.....| .....|.....| .....|.....| .....|.....| .....|.....|
      785      795      805      815      825      835
GRMZM2G419836  TGGTAAATGA TCCTCCCCTT TTCTTTTAAG GGGTGTTTGG ATCCCTCCAT TTTAAAGAAA
                TGGTAAATGA TCCTCCCCCT TTCTTTTAAG GGGTGTTTGG ATCCCTCCAT TTTAAATAAA

.....|.....| .....|.....| .....|.....| .....|.....| .....|.....|
      845      855      865      875      885      895
GRMZM2G419836  TTGGAATCTA CTTGATAAAG TATGCTATTT GTTTGGAATT TGACATTTTA CCACTTTCCA
                TTGGAATCTA CTTGATAAAG TATGCTATTT GTTTGGAATT TGACATTCTA CCACTTTCCA

.....|.....| .....|.....| .....|.....| .....|.....| .....|.....|
      905      915      925      935      945      955
GRMZM2G419836  AAGTTTATAG ATAAGACTCA AATTCATAGG ATGAGAGAGT TGA AATTGAT TTTATATATC
                CAGTTTATAG ATAAGACTCA AATTCATAGG ATGAGAGAGT TGA AATTGAT TTTATATATC

.....|.....| .....|.....| .....|.....| .....|.....| .....|.....|
      965      975      985      995      1005     1015
GRMZM2G419836  ACTAGTCTAT GTTCTACTC TCAACTTAT AACACGCTCT TCAACTTAGT CCCCTATGAT
                ACTAGTCTAT GTTCTACTC TCAACTTAT AACACGCTCT TCAACTCAGT CCCCTATGAT

.....|.....| .....|.....| .....|.....| .....|.....| .....|.....|
      1025     1035     1045     1055     1065     1075
GRMZM2G419836  AGAAATGTAG CACATAAATA TCTCTCTCAT ATGGTTAGCA ATAATATACA AATACTTTCT
                AGAAATTTAG CACATAAATA TCTCTTTCAT ATGGTTAGCA ATAATATACA AATAC-----

.....|.....| .....|.....| .....|.....| .....|.....| .....|.....|
      1085     1095     1105     1115     1125     1135
GRMZM2G419836  ATAAAAATCA TATTAGCTTA ATTGATTTAT GTCTAAATCA CGATTATTAG AATGAAATTG
                -----A TATTAGCTTA ATTGATTTAT GTCTAAATTA CGATTATTAG AATGAAATTG

.....|.....| .....|.....| .....|.....| .....|.....| .....|.....|
      1145     1155     1165     1175     1185     1195
GRMZM2G419836  AATTCCAAGG ATCCAAACGA GCGCAAGGT TATCATGTTT CATTGTGCTT ATTTACCTCG
                AATTCCAAGG ATCCAAACTA GCGCAAGGT TATTATGTTT CATTGTGCTT ATTTACCTCG

.....|.....| .....|.....| .....|.....| .....|.....| .....|.....|
      1205     1215     1225     1235     1245     1255
GRMZM2G419836  TACAGTGTCA GTTTGAAAAC TTAAGTTCGG TCATCACACC ATTTAGACCA AACATTGCAT
                TACAGTGTCA GTTTGAAAAC TTAAGTTCGG TCATCACACC ATTTAGACCA AACATTGCAT

.....|.....| .....|.....| .....|.....| .....|.....| .....|.....|
      1265     1275     1285     1295     1305     1315
GRMZM2G419836  TCAGTTATGT GACTTGCGCA GCTTGAGGGA CAATGCCATG AAAATGGAAA AAAAAATTGG
                TCAGTTATGT GACTTGCGCA GCTTGAGGGA CAATGCCATG AAAAT----- -----

.....|.....| .....|.....| .....|.....| .....|.....| .....|.....|
Gene Deletion

.....|.....| .....|.....| .....|.....| .....|.....| .....|.....|
      1505     1515     1525     1535     1545     1555
GRMZM2G419836  CCCATGAAAA TACCCAGGCG TTTGTTTTGA TTCTTGACA TTGTGAAGAT TGTCACCTTA
                ----- -ACCCAGGCG TTTGTTTTGA TTCTTGACA TTGTGAAGAT TGTCACCTTA

.....|.....| .....|.....| .....|.....| .....|.....| .....|.....|
      1565     1575     1585     1595     1605     1615
GRMZM2G419836  GTATTTAATT ACTTTGCACA ACAATGAAAG GGTGAGAAGG AGCTTCATAC GGTATATATG
                GTATTTAATT ACTTTGCACA ACAATGAAAG GGTGAGAAGG AGCTTCATAC GGTATATATG

.....|.....| .....|.....| .....|.....| .....|.....| .....|.....|
      1625     1635     1645     1655     1665     1675
GRMZM2G419836  CTATCACTCT TATTACTTAG TTCCACGAGT AGATATGATT TCTAAAGGTT TGCCAGACCA
                CTATCACTCT TATTACTTAG TTCCACGAGT AGATATGATT TCTAAAGGTT TGTCAGACCA

.....|.....| .....|.....| .....|.....| .....|.....| .....|.....|
      1685     1695     1705     1715     1725     1735
GRMZM2G419836  ACGCCAACGG TGGTGACATC AAGTGGGCAT TGGTTCACA TTAGTATGAC TGGTTGAAGA
                ACGCCAACGG TGGTGACATC AAGTGGGCAT TGGTTCACA TTAGTATGAC TGGTTGAAGA

```



```

.....|.....| .....|.....| .....|.....| .....|.....| .....|.....|
1745      1755      1765      1775      1785      1795
GRMZM2G419836  TATGTGAATA TGTGAGATGG TTGAACATTC ATCCTTGGTG ATGGAAGCAG TGATTTGTTG
TATGTGAATA TGTGAGATGG TTGAACATTC ATCCTTGGTG ATGGAAGCAG TGATTTGTTG

.....|.....| .....|.....| .....|.....| .....|.....| .....|.....|
1805      1815      1825      1835      1845      1855
GRMZM2G419836  AATTGCATCA TGCCTGGCCA TCAAGGGTGT TAAGTTACAA CCAGGGACTT CGGTGCGATA
AATTGCATCA TGCCTGGCCA TCAAGGGTGT TAAGTTACAA CCAGGGACTT CGGTGCGATA

.....|.....| .....|.....| .....|.....| .....|.....| .....|.....|
1865      1875      1885      1895      1905      1915
GRMZM2G419836  TCTACTTTCT TCACCAGTT- --ACTAATG GAGCATTATA TCAGTTGTTG CTGATGCATA
TCTACTTTTT TCACCAGTTG GTACTAATG GAGCATTATA TCAGTTGTTG CTGATGCATA

.....|.....| .....|.....| .....|.....| .....|.....| .....|.....|
1925      1935      1945      1955      1965      1975
GRMZM2G419836  CGGTTTACTT AACTGTTCAA GTAATTAATT GATTATGATA CAGTCGTCAA TTGGTGTCCA
CGGTTTACTT AACTGTTCAA GTAATTAATT GATTATGATA CAGTCGTCAA TTGGTGTCCA

.....|.....| .....|.....| .....|.....| .....|.....| .....|.....|
1985      1995      2005      2015      2025      2035
GRMZM2G419836  TGCATAAGTA CTTCTCTGT TCTCAAATTA TTGTTTACTT TGTCTTTGTC CTAAGTCAAA
TGCAGAAGTA CTTCTCTGT TCTCAAATTA TTGTTTACTT TGTCTTTGTC CTAAGTCAAA

.....|.....| .....|.....| .....|.....| .....|.....| .....|.....|
2045      2055      2065      2075      2085      2095
GRMZM2G419836  CTATTTTACT CTGACTAAGT TTATAGAAAA A-TGTACTAA CATCTACAAC ATCAAATTAG
CTATTTTACT CTGACTAAGT TTATAGAAAA ATGTACTAA CATCTACAAC ATCAAATTAG

.....|.....| .....|.....| .....|.....| .....|.....| .....|.....|
2105      2115      2125      2135      2145      2155
GRMZM2G419836  TTTCATTAAA TTATTCATGA AATATATTTT GATATAACTC TTATTCGAAA TTGTAGGTGT
TTTCATTAAA TTATTCATGA AATATATTTT GATATAACTC TTATTCGAAA TTGTAGGTGT

.....|.....| .....|.....| .....|.....| .....|.....| .....|.....|
2165      2175      2185      2195      2205      2215
GRMZM2G419836  TGATACATTT TTCGAAAAAA AAAAAGTCTG AAAGCTAGTG AAATTTGGCT TAATACAAA
TGATACATTT TTCGAAAAAA AAAAAGTCTG AAAGCTAGTG AAGTTTGGCT TAATACAAA

.....|.....| .....|.....| .....|.....| .....|.....| .....|.....|
2225      2235      2245      2255      2265      2275
GRMZM2G419836  CCAAAGTAAA TTATGATTCA GAGTAGAATG AGTACTATCG TTTTAAATTG GCCAATAGGT
CCAAAGTAAA TTATGATTCA GAGTAGAATG AGTACTATCG TTTTAAATTG GCCAATAGGT

.....|.....| .....|.....| .....|.....| .....|.....| .....|.....|
2285      2295      2305      2315      2325      2335
GRMZM2G419836  TAGTTTACAT TTTAGAAGAA GAATGTGAAT AGAGAGCTCA ACATAGGTTT ACTTGAGGGT
TAGTTTACTT TTTAGAAGAA GAAAGTGAAT AGAGAGCTCA ACATAGGTTT ACTTGAGGGT

.....|.....| .....|.....| .....|.....| .....|.....| .....|.....|
2345      2355      2365      2375      2385      2395
GRMZM2G419836  TGATGGAAAA CCTGCTCTGA CAATTTTGCA TGTGTACGGA TATGTGATAG TTCTGGTGGG
TGATGGAAAA CCTGCTCTGA CAATTTTGCA TGTGTACGGA TGTGTGATAG TTCTGGTGGG

.....|.....| .....|.....| .....|.....| .....|.....| .....|.....|
2405      2415      2425      2435      2445      2455
GRMZM2G419836  GCTGCTAGTT TTTTAAAACA TGGACTTGTG CGACT--GTG TATTAAGTGT GCACGTAAGC
GCTGCTAGTT TTTTAAAACA TGGACTTGTG CGACTTTGTG TATTAAGTGT GCACGTAAGC

.....|.....| .....|.....| .....|.....| .....|.....| .....|.....|
2465      2475      2485      2495      2505      2515
GRMZM2G419836  TATAGGCTGA TATCTCTTCC TTTTACAGGT ATTGGCAAAT GCCAAGTTTA AAATTACGAA
TATAGGCTGA TATCTCTTCC TTTTACAGGT ATTGGCAAAT GCCAAGTTTA AAATTACGAA

.....|.....| .....|.....| .....|.....| .....|.....| .....|.....|
2525      2535      2545      2555      2565      2575
GRMZM2G419836  ATTTCCATT CGGATGAGCT GAGGCAGTTA GAATTTATAT TATCGCGTTA AGGTGCTGAA
ATTTCCATT CGGATGAGCT GAGGCAGTTA GAATTTATAT TATCGCGTTA AGGTGCTGAA

```

```

.....|.....| .....|.....| .....|.....| .....|.....| .....|.....|
2585      2595      2605      2615      2625      2635
GRMZM2G419836 GCGACCACAG GTTTCAGCAT CATAATAGTT CTTGATGATT GAAGCTAATC CACATAGAAC
GCGACCACAG GTTTCAGCAT CATAATAGTT CTTGATGATT GAAGCTAATC CACATAGAAC

.....|.....| .....|.....| .....|.....| .....|.....| .....|.....|
2645      2655      2665      2675      2685      2695
GRMZM2G419836 AACCAATAAG CACTGTGGGT TGTGCTTCTG CTGCCATAAA ATGACAGTCC TTGTTTACCA
AACCAATAAG CACTGTGGGT TGTGCTTCTG CTGCCATAAA ATGACAGTCC TTGTTTACCA

.....|.....| .....|.....| .....|.....| .....|.....| .....|.....|
2705      2715      2725      2735      2745      2755
GRMZM2G419836 GCCTAGTTTG GATTATGACC TTATTATTTT TTGAATGTAC ATCTGCAACT CTGCACCGGA
GCCTAGTTTG GATTATGACC TTATTATTTT TTGAATGTAC ATCTGCAACT CTGCACCGGA

.....|.....| .....|.....| .....|.....| .....|.....| .....|.....|
2765      2775      2785      2795      2805      2815
GRMZM2G419836 GCATCATACC ACTGCTCCAA GCATATATCA TTTATGTAAA AACTGAAATG AAAATTCAAT
GCATCATACC ACTGCTCCAA GCATCTATCA TTTATGTAAA AACTGAAATG AAAATTCAAT

.....|.....| .....|.....| .....|.....| .....|.....| .....|.....|
2825      2835      2845      2855      2865      2875
GRMZM2G419836 ATTCTGACAG TCAATTTGTT TTTTAACCGC TTGCAGCTTC TGCATTATGA TATCAGATAC
ATTCTGACAG TCAATTTATT TTTTAACCGC TTGCAGCTTC TGCATTATGA TATCAGATAC

.....|.....| .....|.....| .....|.....| .....|.....| .....|.....|
2885      2895      2905      2915      2925      2935
GRMZM2G419836 GTCCCTTGCT TCGTGCTCCT GGACAAGCAC GGTAGAGCTC TAGCGAAGAC TGGAGTACCA
GTCCCTTGCT TCGTGCTCCT GGACAAGCAC GGTAGAGCTC TAGCGAAGAC TGGAGTACCA

.....|.....| .....|.....| .....|.....| .....|.....| .....|.....|
2945      2955      2965      2975      2985      2995
GRMZM2G419836 ACCAGCCGGC AGCACGTTGT CGCCGGTCTC CATCACCTCC TGAGGATGCA GCAGCCATCC
ACCAGCCGGC AGCACGTTGT CGCCGGTCTC CATCACCTCC TGAGGATGCA GCAGCCATCC

.....|.....| .....|.....| .....|.....| .....|.....| .....|.....|
3005      3015      3025      3035      3045      3055
GRMZM2G419836 GGACTGGAAG GAAACCAGAA TGCGCCTCCG TCATGAAGCC CAAATACCTG AGCAAGGCCT
GGACTGGAAG GAAACCAGAA TGCGCCTCCG TCATGAAGCC CAAATACCTG AGCAAGGCCT

.....|.....| .....|.....| .....|.....| .....|.....| .....|.....|
3065      3075      3085      3095      3105      3115
GRMZM2G419836 GTATTGACAA AGAAAAATT- TTCAGAATGT GCCTTTTGTT TTTGCAAGCA TGAACAATGG
GTATTGACAG AGAAAAAAA TTCAGAATGT GCCTTTTGTT TTTGCAAGCA TGAACAATGG

.....|.....| .....|.....| .....|.....| .....|.....| .....|.....|
3125      3135      3145      3155      3165      3175
GRMZM2G419836 GCAAACATTG ATGCGTTAAT TCTTTAGCTG GTAAGTACAG ATTGAAGTTG GTGCAAAAGC
GCAAACATTG ATGCGTTAAT TCTTTAGCTT TTTAGTACAG ATTGAAGTTG GTGCAAAAGC

.....|.....| .....|.....| .....|.....| .....|.....| .....
3185      3195      3205      3215      3225
GRMZM2G419836 AAAAGGCAGG TGGTATTTTT TTATGATAT CCGCCTGAA ATAA
AAAAGGCAGT TGGTATTTTT TTGGTAGTA CAGCGTGAAG ACCA

```

## GRMZM2G027021

.....|.....| .....|.....| .....|.....| .....|.....| .....|.....|  
 5 15 25 35 45 55  
 GRMZM2G027021 ACCAATCGAA CTGAATGGAC CAGTCGACGT CATCGCCTCC CTCGCCTATC CGCTCGGCCG  
 ACCAATCGAA CCGAATGGAC CAGTCGACGT CATCGCCTCC CCCGCCTATC CGCTCGGCCG

.....|.....| .....|.....| .....|.....| .....|.....| .....|.....|  
 65 75 85 95 105 115  
 GRMZM2G027021 TTGGCGCTCA CAAAAACCAC CCAGAAGCCT CCGCTTGACC GCTTCACTCG CTTTCCGCC  
 TTGGCGCTCA CAAAAACCAC CCAGAAGCCT CCGCTTGACC GCTTCACTCG CTTTCCGCC

.....|.....| .....|.....| .....|.....| .....|.....| .....|.....|  
 125 135 145 155 165 175  
 GRMZM2G027021 GCCGCGCCAT GAGCGCCGCC GCCTGCCTGT TCGCTGCCGC CGTCTCCCTA TCATTCCCGT  
 GCCGCGCCAT GAGCGCCGCC GCCTGCATGT TCGCTGCCGC CGTCTCCCTA TCATTCCCGT

.....|.....| .....|.....| .....|.....| .....|.....| .....|.....|  
 185 195 205 215 225 235  
 GRMZM2G027021 CGACCTCCGC ACCCTCTTCC GCAAGACGCC GCCGCCTCCG GAGCCCCACC ACCCTCTTCC  
 CGACCTCCGC ACCCTCTTCC GCAAGTCGCC GCCGCCTCCG GAGCCCCACC ACCCTCTTCC

.....|.....| .....|.....| .....|.....| .....|.....| .....|.....|  
 245 255 265 275 285 295  
 GRMZM2G027021 GCTGCTCCCC GACTCGCCGC CGTGGGCCGG TCCGGCGGAC ACTCGACGAG CGGCTGCTCG  
 GCTGCTCCCC GACTCGCCGC CGTGGGCCGG TCCGGCGGAC ACTCGACGAG CAGCTGCTCG

.....|.....| .....|.....| .....|.....| .....|.....| .....|.....|  
 305 315 325 335 345 355  
 GRMZM2G027021 AGGCCGCGCC GCGGAGACC GAAGACGTCC AAACCGCTGT TGATGTAGAG GATGGAGGAG  
 AGGCCGCGCC GCGGAGACC GAAGACGTAC AAACCGCTCT TGATGTAGAG GATGGAGGAG

.....|.....| .....|.....| .....|.....| .....|.....| .....|.....|  
 365 375 385 395 405 415  
 GRMZM2G027021 GGATCGCTGA GGGCGATGAA GTGGGAACAG AGGAGATGGA GGAGCTGGAG CAGCGACCGC  
 GGATCGCTGA GGGCGATGAA GTGGGAACAG AGGAGATGGA GGAGCTGGAG CAGCGCCCGC

.....|.....| .....|.....| .....|.....| .....|.....| .....|.....|  
 425 435 445 455 465 475  
 GRMZM2G027021 CGACGAGGGC TTTCGTGAAG AGCAGGCGGC AGCGGCAGGA AGAGGAGGAA GCCGCGGCGG  
 CGCCGAGGGC TTTCGTGAAG AGCAGGCGGC AGCGGCAGGA AGAGGAGGAA GCCGCGGCGT

.....|.....| .....|.....| .....|.....| .....|.....| .....|.....|  
 485 495 505 515 525 535  
 GRMZM2G027021 GGCAAGACCG GTTCAAGCTC ATCAATGGCA AAGAGGTAGC GGATTGCGTA GCTTCAGCTG  
 GGCAAGACCG GTTCAAGCTC ATCAATGGCA AAGAGGTAGC GGATTGCGTA GCTTCAGCTG

.....|.....| .....|.....| .....|.....| .....|.....| .....|.....|  
 545 555 565 575 585 595  
 GRMZM2G027021 CTTGCTTTTG TTGCTCCGAC AGGCCCGCTT GGCGCCGGCC TGTTTGACAG ATTGGGCGGT  
 CTTGCTTTTG TTGCTTCGAC AGGCCCGCCT GGCGCCGGCC TGTTTGACAG ATTGGGCGGT

.....|.....| .....|.....| .....|.....| .....|.....| .....|.....|  
 605 615 625 635 645 655  
 GRMZM2G027021 TTCTACTCAG CGTGTGGAGA ATATGATAAC CTGCAGCGAT CCATCAAATT CACCGGAGAG  
 TTCTACTCAG CGTGTGGAGA ATATGATAAC CTGCAGCGAT CCATCAAATT CACCGGAGAG

.....|.....| .....|.....| .....|.....| .....|.....| .....|.....|  
 665 675 685 695 705 715  
 GRMZM2G027021 AACTTTTGAT TGTTACATCC CCGCTAGATA TTTTGGGCCG TGACATGAAC AATAGAGCTG  
 AACTTTTGAT TGTTACATCC CCGCTAGATA TTTTGGGCCG TGACATGAAC AATAGAGCTG

.....|.....| .....|.....| .....|.....| .....|.....| .....|.....|  
 725 735 745 755 765 775  
 GRMZM2G027021 TGAGTTGGTG TTACCTGCCA GTTTCATCAT GTCTGATTTC TG~~~~AACC TGTGACCTG  
 TGAGTTGGTG TTGCCTGCCA GTTTCATCAT GTCTGATTTC TGTCTGAACC TGTGTACCTG

.....|.....| .....|.....| .....|.....| .....|.....| .....|.....|  
 785 795 805 815 825 835  
 GRMZM2G027021 GCTACCTGCA GATATTCAA GAGAAGGCTT ATCTGGTTGG TGTGAGTGC AAACGGACAG  
 GCTACCTGCA GATATTCAA GAGAAGGCTT ATCTGGTTGG TGTGAGTGC AAACGGACAG

	.... ....  .... ....  .... ....  .... ....  .... ....  .... ....
	845 855 865 875 885 895
GRMZM2G027021	GAGGGAACCT GTTCGGCATA GAGGAGTCCC TTAAGGAGCT GGAGCAGTTG GCTGATACGG GAGGGAACCT GTTCGGCATA GAGGAGTCCC TTAAGGAGCT GGAGCAGTTG GCTGATACGG
	.... ....  .... ....  .... ....  .... ....  .... ....  .... ....
	905 915 925 935 945 955
GRMZM2G027021	CGGGCCTTCT GGTAGTCGGC TCAACCTATC AGAAGTAAGC TTCAGTTTGA CGGGAACATC CGGGCCTTCT GGTAGTCGGC TCAACCTATC AGAAGTAAGC TTCAGTTTGA CTGGAACATC
	.... ....  .... ....  .... ....  .... ....  .... ....  .... ....
	965 975 985 995 1005 1015
GRMZM2G027021	TCGACTGAGC CTGCACTGTG CTCTACTAGC AATCGTGGTT ACACGTTCTC ACCATAGATA TCGACTGAGC CTGCGCTGTG CTCTACTAGC AATCATGGTT ACACGTTTTC ACCATAGATA
	.... ....  .... ....  .... ....  .... ....  .... ....  .... ....
	1025 1035 1045 1055 1065 1075
GRMZM2G027021	AGATGGGACA CCACGGAAAA ACTGAGATGC CTGGTCAATC TAATTCGTGG TCCACAGAAA AGATGGGACA CCACGGAAAA ACTGAGATGC CTGGTCAATC TAATTCGTGG TCCACAGAAA
	.... ....  .... ....  .... ....  .... ....  .... ....  .... ....
	1085 1095 1105 1115 1125 1135
GRMZM2G027021	CTTCACGGGC AACTTGGATA GATGAAATGA TACTGTTAGT TCAGATTTTC AAAATGTACT CTTCACGGGC AACTTGGATA GATGAAATGC TACTGTTAGT TCAGATTTTC AAAATGTACT
	.... ....  .... ....  .... ....  .... ....  .... ....  .... ....
	1145 1155 1165 1175 1185 1195
GRMZM2G027021	CTGCAGCTGT TAGGGCCTAA GAAGGCCAC GGAGGACTGC AGCAGCAGCA ACGATGGGCC CTGCAGC~~~~ ~~~~~~ ~~~~~~ ~~~~~~ ~~~~~~ ~~~~~~
	.... ....  .... ....  .... ....  .... ....  .... ....  .... ....
	Gene Deletion
	.... ....  .... ....  .... ....  .... ....  .... ....  .... ....
	3245 3255 3265 3275 3285 3295
GRMZM2G027021	ATTGCCACAA TCTGAAATAA ATATAGTCA AATTTCCCTC TTAATTTCTC GTATAAGTTG ATTGCCACAA TCTGAAATAA ATATAGTCA AATTTCCCTC TTAATTTCTC GTATAAGCTG
	.... ....  .... ....  .... ....  .... ....  .... ....  .... ....
	3305 3315 3325 3335 3345 3355
GRMZM2G027021	TATTGTTATG TTCTTATGTA AGATTGTAAG ACTATG~~~~ ~~~~~CATGA CATACATACC TATTGTTATG TTCTTATGTA AGATTGTAAG ACTATGCCAG TATGGCATGA CATACAAACC
	.... ....  .... ....  .... ....  .... ....  .... ....  .... ....
	3365 3375 3385 3395 3405 3415
GRMZM2G027021	ACATGGCTTG CCTTTTCTTA TTTCTACAGA GTACAGTGGT TCTCATGCTT TCTATTTTTC ACTTGGCTTG CCTTTTCTTA TTTCTACAGA GTACAGTGGT TCTCATGCTT TCTATTTTCC
	.... ....  .... ....  .... ....  .... ....  .... ....  .... ....
	3425 3435 3445 3455 3465 3475
GRMZM2G027021	AATAGGCTTT CTACCCAAA TCCAAGGACT TACATTGGTT CAGGAAAGGT TTCTGAAATC AATAGGCTTT CTACCCAAA TCCAAGGACT TACATTGGTT CAGGAAAGGT TTCTGAAATC
	.... ....  .... ....  .... ....  .... ....  .... ....  .... ....
	3485 3495 3505 3515 3525 3535
GRMZM2G027021	AGGACTGCAA TCCAAGCACT TGATGTTGAG ACTGTAATTT TAGACGATGA GTTATCCCTT AGGACTGCAA TCCAAGCACT TGATGTTGAG ACTGTAATTT TGGACGATGA GTTATCCCTT
	.... ....  .... ....  .... ....  .... ....  .... ....  .... ....
	3545 3555 3565 3575 3585 3595
GRMZM2G027021	GGGTAAGATT CTCACTTATT ACTCTGCTTG TTAGAGTACC CGTTTAGGGT TTGGGGTTTA GGGTAAGATT CTCACTTATT ACTCTGCTTG TTAGAGTACC CATTTAGGGT TTGGGGTTTA
	.... ....  .... ....  .... ....  .... ....  .... ....  .... ....
	3605 3615 3625 3635 3645 3655
GRMZM2G027021	CCCCGTGTAT TTACCTTCTC ACCCCTATGT AAAGGGCCAA GCCTATCTAA CTTAGTCTAT CCCCGTGTAT TTACCTTCTC TCCCTGTGT AAAGGGCCAA ATCCATCTAA CTTAGTCTAT

	.... ....  .... ....  .... ....  .... ....  .... ....
	3665 3675 3685 3695 3705 3715
GRMZM2G027021	TAATATATCA CCCAACCCCT TGTTAGGGTT <b>AGGG</b> TTTTCC ACATGGTATA GAGTTAGGTT
	TAATATATCA CCCAACCCCT TGTTAGGG~ ~~~~TTTTC ACATGGTATA GAGATAGGTT
	.... ....  .... ....  .... ....  .... ....  .... ....
	3725 3735 3745 3755 3765 3775
GRMZM2G027021	TCTTTTTTC CTCTTCTACT CCCACCCACC CGCCTCCACT <b>TTCCTGCTAG</b> CAAG~~~~~
	TCTTTTTT~C CTCTTCTCCT CCCACCCACC CGCCTCCACT <b>TCCCTGCCAG</b> CAAG <b>CCCCAG</b>
	.... ....  .... ....  .... ....  .... ....  .... ....
	<b>Gene Insertion</b>
	.... ....  .... ....  .... ....  .... ....  .... ....
	8945 8955 8965 8975 8985 8995
GRMZM2G027021	~~~~~ TCCA TCTAACTCAG <b>TCT</b> TATTAATA CAT <b>A</b> ACCCAA <b>CC</b> CCTTGTTA
	<b>TATGTAATGG</b> <b>GCCAG</b> ACCCA TCTAACTAAG <b>TT</b> TATTAATA CAT <b>C</b> ACCCAA <b>CC</b> TCTTGTTA
	.... ....  .... ....  .... ....  .... ....  .... ....
	9005 9015 9025 9035 9045 9055
GRMZM2G027021	GGGTTA <b>G</b> AGT TTCCCACACT GCTTATGTGA <b>TTCC</b> ATTTGA TTTCCGTGTT TGTTCATATCT
	GGGTTA <b>G</b> GGT TTCCCACACT GCTTATGTGA <b>TTCC</b> ATCTGA TTTCCGTGTT TGTTCATATCT
	.... ....  .... ....  .... ....  .... ....  .... ....
	9065 9075 9085 9095 9105 9115
GRMZM2G027021	<b>G</b> AGACCCGTC AAATGAACCC AACTGTATGA TCTTTGCCTT GTACTAATCG TTAACTATTA
	<b>A</b> AGACCCGTC AAATGAACCC AACTGTATGA TCTTTGCCTT GTACTAATCG TTAACTATTA
	.... ....  .... ....  .... ....  .... ....  .... ....
	9125 9135 9145 9155 9165 9175
GRMZM2G027021	TGCTCAAAAT ATTGGTCAGT CATCATACTT GTTATCTTCA GTTCAGAGAA TACCTGAAAG
	TGCTCAAAAT ATTGGTCAGT CATCATACTT GTTATCTTCA GTTCAGAGAA TACCTGAAAG
	.... ....  .... ....  .... ....  .... ....  .... ....
	9185 9195 9205 9215 9225 9235
GRMZM2G027021	AGTGTTATTT GTTAATCTCA TAAATGGATG CCGGTATGTA ATCAAATTTT TATTCTTCCT
	AGTGTTATTT GTTAATCTCA TAAACGGATG CCAGTATGTA ATCAAATTTT TATTCTTCCT
	.... ....  .... ....  .... ....  .... ....  .... ....
	9245 9255 9265 9275 9285 9295
GRMZM2G027021	CTATACATAA CCAGGATATA TTTGAAGAAT TTATCTTATG ATTT <b>CGACAC</b> CATGTATTGT
	CTATACATAA CCAGGATATA TTTGAAGAAT TTATCTTATG ATTT <b>CGAAA</b> A CATGTATTGT
	.... ....  .... ....  .... ....  .... ....  .... ....
	9305 9315 9325 9335 9345 9355
GRMZM2G027021	GTCGACCATA CATTGTTTTT AACTTCTTCC TAATCATATT TTA <b>AACTGCT</b> AACCACCTCA
	GTCGACCATA CATTGTTTTT AACTTCTTCC TAATCATATT TTA <b>AACTGCT</b> AACCACCTCA
	.... ....  .... ....  .... ....  .... ....  .... ....
	9365 9375 9385 9395 9405 9415
GRMZM2G027021	GATTGGCCTA ATAGTTACTC TGGT <b>A</b> GCTCA TATTCCCAAC AATGATTTCA GACA <b>ACTACG</b>
	GATTGGCCTA ATAGTTACTC TGGT <b>T</b> GCTCA TATTCCCAAC AATGATTTCA GACA <b>ACTACG</b>
	.... ....  .... ....  .... ....  .... ....  .... ....
	9425 9435 9445 9455 9465 9475
GRMZM2G027021	TAACTTGAA AAGTCATTTG GTGGGAGTGT CCGAGTCTGT GATCGAACTG CTCTTATTCT
	TAACTTGAA AAGTCATTTG GTGGGAGTGT CCGAGTCTGT GATCGAACTG CTCTTATTCT
	.... ....  .... ....  .... ....  .... ....  .... ....
	9485 9495 9505 9515 9525 9535
GRMZM2G027021	TGATATTTT AATCAAAGGG CAGCAACACA TGAAGCTTCT TTACAGGTAA AAATCACATA
	TGATATTTT AATCAAAGGG CAGCAACACA TGAAGCTTCT TTACAGGTAA AAATCACATA
	.... ....  .... ....  .... ....  .... ....  .... ....
	9545 9555 9565 9575 9585 9595
GRMZM2G027021	CAGTAGCTT <b>T</b> ACCAACAGTA GTATCTTGTG GCATCATTTC TTGACATGAA GTTTGCAGCT
	CAGTAGCTT <b>C</b> ACCAACAGTA GTATCTTGTG GCATCATTTC TTGACATGAA GTTTGCAGCT

	.... ....	.... ....	.... ....	.... ....	.... ....	.... ....
	9605	9615	9625	9635	9645	9655
GRMZM2G027021	TTAAGTAGAG	TGAACATGTT	TGTTGTCCAC	GTAAGTTACT	CTATATCATG	TTTTCCTTTT
	TTAAGTAGAG	TGAACATGTT	TGTTGTCCAC	GTAAGTTACT	CTATATATG	TTTTCCTTTT
	.... ....	.... ....	.... ....	.... ....	.... ....	.... ....
	9665	9675	9685	9695	9705	9715
GRMZM2G027021	TAGGTTACTT	TGGCACAGAT	GGAATATCAA	CTTCCTAGGT	TGACGAAAAT	GTGGAGTCAC
	TAGGTTACTT	TGGCACAGAT	GGAATATCAA	CTTCCTAGGT	TGACGAAAAT	GTGGAGTCAC
	.... ....	.... ....	.... ....	.... ....	.... ....	.... ....
	9725	9735	9745	9755	9765	9775
GRMZM2G027021	CTGGAACGGC	AGGCTGGAGG	TCAAGTTAAG	GGTATGGGTG	AGAAGCAAAT	TGAAGTTGAC
	CTGGAACGGC	AGGCTGGAGG	TCAAGTTAAG	GGTATGGGTG	AGAAGCAAAT	TGAAGTTGAC
	.... ....	.... ....	.... ....	.... ....	.... ....	.... ....
	9785	9795	9805	9815	9825	9835
GRMZM2G027021	AAGCGCATCT	TGAGAACTCA	AGTATTACTC	TTTCTGGAAG	TCATAGATTT	TTTTTGCTCA
	AAGCGCATCT	TGAGAACTCA	AGTATTACTC	TTTCTGGAAG	TCAGAGATAT	TTTTTGCTCA
	.... ....	.... ....	.... ....	.... ....	.... ....	.... ....
	9845	9855	9865	9875	9885	9895
GRMZM2G027021	ATAATGGACA	CATGACTATG	TTATTAGCTA	CCACTATTGG	TCAATGACAG	TGCACTCCGT
	ATAATGGACA	CATGACTATG	TTATTAGCTA	CCACTATTGG	TCAATGACAG	TGCACTCCGT
	.... ....	.... ....	.... ....	.... ....	.... ....	.... ....
	9905	9915	9925	9935	9945	9955
GRMZM2G027021	CTCTAATGAC	TGGAATAAAA	AATAGATGGC	TGGTAGACAT	TTCTTAATAA	AATGGCAAAC
	CTCTAATGAC	TGGAATAAAA	AATAGATGGC	TGGTAGACAT	TTCTTAATAA	AATGGCAAAC
	.... ....	.... ....	.... ....	.... ....	.... ....	.... ....
	9965	9975	9985	9995	10005	10015
GRMZM2G027021	TTCTATTGAT	AATTCATTTG	TAGGACTTTA	TATTTTCCAT	GTCGTATTGT	ACATTGCTGA
	TTCTATTGAT	AATTCATTTG	TAGGACTTTA	TATTTTCCAT	GTCGTATTGT	ACATTGCTGA
	.... ....	.... ....	.... ....	.... ....	.... ....	.... ....
	10025	10035	10045	10055	10065	10075
GRMZM2G027021	ATTTGTAGTG	CTGATCTTTT	TTT~GTGGAA	CTTGTGGGTC	TCAAACATAA	GTGTCATTGA
	ATTTGTAGTG	CTGATCTTTT	TTTGTGGAA	CTTGTGGGTC	TCAAACATAA	GTGTCATTGA
	.... ....	.... ....	.... ....	.... ....	.... ....	.... ....
	10085	10095	10105	10115	10125	10135
GRMZM2G027021	CAGATAAGTG	CCTTGAGGAA	AGAATTGGAA	TCTGTACGGA	AACACCGAAA	GTTGTACCGC
	CAGATAAGTG	CCTTGAGGAA	AGAATTGGAA	TCTGTACGGA	AACACCGAAA	GTTGTACCGC
	.... ....	.... ....	.... ....	.... ....	.... ....	.... ....
	10145	10155	10165	10175	10185	10195
GRMZM2G027021	AACCGTCGCC	AATCAGTTCC	TATTCTGTG	GTTTCTCTGG	TATAACCATG	TACATTTCTT
	AACCGTCGCC	AATCAGTTCC	TATTCTGTG	GTTTCTCTGG	TATAACCATG	TACATTTCTT
	.... ....	.... ....	.... ....	.... ....	.... ....	.... ....
	10205	10215	10225	10235	10245	10255
GRMZM2G027021	TACAATAATA	AAAAACTATC	ATGCTTTCTA	TTCTACAAAT	ATGTTACAGCT	CCAAATAAAT
	TACAATAATA	GAAAACTATC	ATGCTTTCTA	TTCTACAAAT	ATGTTACAGCT	CCAAATAAAT
	.... ....	.... ....	.... ....	.... ....	.... ....	.... ....
	10265	10275	10285	10295	10305	10315
GRMZM2G027021	TTCAGGTAGG	ATATACAAAT	GCTGGAAAAA	GTACTCTCCT	GAACCGCTTA	ACTGGAGCTG
	TTCAGGTAGG	ATATACAAAT	GCTGGGAAAA	GTACTCTCCT	GAACCGCTTA	ACTGGAGCTG
	.... ....	.... ....	.... ....	.... ....	.... ....	.... ....
	10325	10335	10345	10355	10365	10375
GRMZM2G027021	ATGTGCTTGC	AGAGGATAAG	TTATTTGCCA	CATTAGATCC	AACTACTAGA	AGGGTTTTGG
	ATGTGCTTGC	AGAGGATAAG	TTATTTGCCA	CATTAGATCC	AACTACTAGA	AGGGTTTTGG
	.... ....	.... ....	.... ....	.... ....	.... ....	.... ....
	10385	10395	10405	10415	10425	10435
GRMZM2G027021	TATGTTATTA	GAAAACTCTC	CTGGTCCATA	AAAAATGGAA	ACAAAAGCTT	TTTTTGTAT
	TATGTTATTA	GAAAACTCTC	CTGGTCCATA	AAAAATGGAA	ACAAAAGCTT	TTTTTTCAT~~

	.... ....  .... ....  .... ....  .... ....  .... ....
	10445 10455 10465 10475 10485 10495
GRMZM2G027021	GTAAATTGGA TAATGGACAT GAATAAGGTC TGTATCTATT ATGATTTATA TGCCTTTGGG GTAAATTGGA TAATGGACAT GAATAAGGTC TGTATTTATT ATGATTTATA TT~~~~GGG
	.... ....  .... ....  .... ....  .... ....  .... ....
	10505 10515 10525 10535 10545 10555
GRMZM2G027021	AAAGATTTTT TGTAAGAAGT ATCCATCATT ATATCTACAT ATGACCATGA CTGAATGTAA AAAGATTTTT TGTAAGAAGT ATCCATCATT ATATCTACAT ATGACCATGA CTGAATGTAA
	.... ....  .... ....  .... ....  .... ....  .... ....
	10565 10575 10585 10595 10605 10615
GRMZM2G027021	TTATGTATTA CTGTGCAGAT GAAGAATGGG ACTGAGTTCC TTCTAACTGA TACCGTCGGA TTATGTATTA CTATGCAGAT GAAGAATGGG ACTGAGTTCC TTCTAACTGA TACCGTCGGA
	.... ....  .... ....  .... ....  .... ....  .... ....
	10625 10635 10645 10655 10665 10675
GRMZM2G027021	TTCATTCAGA AATTACCCAC TATGCTGGTA CATATCCACA AAGCATATTC CTCTTGTTTA TTCATTCAGA AATTACCCAC TATGCTGGTA CATATCCACA AAGCATATTC CTCTTGTTTA
	.... ....  .... ....  .... ....  .... ....  .... ....
	10685 10695 10705 10715 10725 10735
GRMZM2G027021	CATATCCAAC TTTGCATATA TCATTTATTG ATAATACCTT TTCAGGTAGC AGCATTTAGA CATATCCAAC TTTGCATATA TCATTTATTG ATAATACCTT TTCAGGTAGC AGCATTTAGA
	.... ....  .... ....  .... ....  .... ....  .... ....
	10745 10755 10765 10775 10785 10795
GRMZM2G027021	GCAACACTAG AAGAGATATC GGAATCATCA GTTATAGTTC ATCTTGTGGA CATTAGGTAT GCAACACTAG AAGAGATATC AGAATCATCA GTTATAGTTC ATCTTGTGGA CATTAGGTAT
	.... ....  .... ....  .... ....  .... ....  .... ....
	10805 10815 10825 10835 10845 10855
GRMZM2G027021	GGAACTTATA CTAGGGGTTT TCTTCGTTGT GGATTCAATT TCATGCATCT ATATGCAGTT GGAACTTATA CTAGGGGTTT TCTTCGTTGT GGATTCAATT TCATGCATCT ATATGCAGTT
	.... ....  .... ....  .... ....  .... ....  .... ....
	10865 10875 10885 10895 10905 10915
GRMZM2G027021	ATGCACTGTC CTAATATTGT GTTATGTGTT CCAGCCATCC TTTAGCTCAA CAACAGATAG ATGCACTGTC CTAATATTGT GTCATGTGTT CCAGCCATCC TTTAGCTCAA CAACAGATAG
	.... ....  .... ....  .... ....  .... ....  .... ....
	10925 10935 10945 10955 10965 10975
GRMZM2G027021	ATGCTGTTGA AAGAGTACTG AAGGAGTTGG ATGTCGAGTC AATCCCCAAA TTAGTCTGTG ATGCTGTTGA AAGAGTACTG AAGGAGTTGG ATGTCGAGTC AATTCCCCAAA TTAGTTGTGT
	.... ....  .... ....  .... ....  .... ....  .... ....
	10985 10995 11005 11015 11025 11035
GRMZM2G027021	GGAATAAGGT TTGTTTGCTC AAATATTGGA CCTGTTGGT AAAATTTTCA ACGTTTTTAC GGAATAAGGT TTGTTTGCTC AAATATTGGA TCTGTTGGT AAAATTTTCA ACGTTTTTAC
	.... ....  .... ....  .... ....  .... ....  .... ....
	11045 11055 11065 11075 11085 11095
GRMZM2G027021	TTTATTTTAT ATTTTATAGAG AGTAGAGATG AGATTTTCTG ATCATAGTCT TTCTATGCTG TTTATTTTAT ATTTTATAGAG AGTAGAGATG AGATTTTCTG ATCATAGTCT TTCTATGCTG
	.... ....  .... ....  .... ....  .... ....  .... ....
	11105 11115 11125 11135 11145 11155
GRMZM2G027021	GATTTAGTAT CAATTTCTAC TTTCTATATG TTAATCCCCT ATTTTAAACT TCTCTTACA GATTTAGTAT CAATTTCTAC TTTCTATATG TTAATCCCCT ATTTTAAACT TCTCTTTGCA
	.... ....  .... ....  .... ....  .... ....  .... ....
	11165 11175 11185 11195 11205 11215
GRMZM2G027021	AACGGTGTCA TCTACAGTTC CGCGTCGTCT ATTTTGCAAG ATCCACTGAA GACAACCTTA AACGGTGTCA TCTACAGTTC CGCGTCGCTT ATTTTGCAAG ATTCACTGAA GACA~~~~TA
	.... ....  .... ....  .... ....  .... ....  .... ....
	11225 11235 11245 11255 11265 11275
GRMZM2G027021	CGGTGGACTA AAATAGTGTG AAGCTTTTTT GAGCAAAAGT TGTGCTGAA TGTA AAAAGGC CGGTGGATTA AAATAGTGTG AAGCTTTTTT GATCAAAAGT TGTGCTGAA TGTA AAAAGGC

	.... ....	.... ....	.... ....	.... ....	.... ....	.... ....
	11285	11295	11305	11315	11325	11335
GRMZM2G027021	TTCTCATTTTC	TGATCCACCT	CTGCCTATCA	CTCACTCTGA	ATAGATGATG	TTCATATAAG
	TTCTCATTTTC	TGATCCACCT	CTGCCTATCA	CTCACTCTGA	ATAGATGATG	TTCATATAAG
	.... ....	.... ....	.... ....	.... ....	.... ....	.... ....
	11345	11355	11365	11375	11385	11395
GRMZM2G027021	AAAATTAATG	CAGTAGTAAA	TCCCTAATAT	TTATATAAAT	GTTGCAGGGT	TCTGTGGAGC
	AAAATTAATG	CAGTAGTAAA	TCCCTAATAT	TTATATAAAT	GTTGCAGGGT	TCTGTGGAGC
	.... ....	.... ....	.... ....	.... ....	.... ....	.... ....
	11405	11415	11425	11435	11445	11455
GRMZM2G027021	TTTGATTGTC	ATTAGTCAT	TTTTTA~TCT	AATCTTCAAG	ATCAATCAGA	ATCATAGTCA
	TTTGATTGTC	ATTAGTCAT	TTTTTAATCT	AATCTTCAA	ATCAATCAGA	ATCATAGTCA
	.... ....	.... ....	.... ....	.... ....	.... ....	.... ....
	11465	11475	11485	11495	11505	11515
GRMZM2G027021	GGAGTTTGTA	ATAATAGTGC	AAATAATGAT	GCAATCATGC	AAACAAGACA	AAATTATACA
	GGAGTTTGTA	ATAATAGTGC	AAATAATGAT	GCAATCATGC	AAACAAGACA	AAATTATACA
	.... ....	.... ....	.... ....	.... ....	.... ....	.... ....
	11525	11535	11545	11555	11565	11575
GRMZM2G027021	TTTTCAACTG	GATCTGATTC	TTCAAGTGCT	TCCTTTTTGG	AACTAAGACA	TATTTGTATG
	TTTTCAACTG	GATCTGATTC	TTCAAGTGCT	TCCTTTTTGG	AACTAAGACA	TGTTTTGTATG
	.... ....	.... ....	.... ....	.... ....	.... ....	.... ....
	11585	11595	11605	11615	11625	11635
GRMZM2G027021	TCATGCAGAT	TGACAATACG	GATGAACCAT	TGAGTGTA	AGAGGAGGCT	CAGAAACAAG
	TCATGCAGAT	TGACAATACG	GATGAACCAT	TGAGTGTA	AGAGGAGGCT	CAGAAACAAG
	.... ....	.... ....	.... ....	.... ....	.... ....	.... ....
	11645	11655	11665	11675	11685	11695
GRMZM2G027021	GAATAATCTG	CATATCAGCG	ATGAATGGTG	ATGGTTTGG	AGATTTATGT	AATGCAGTTC
	GAATAATCTG	CATATCAGCG	ATGAATGGTG	ATGGTTTGG	AGATTTATGT	AATGCAGTTC
	.... ....	.... ....	.... ....	.... ....	.... ....	.... ....
	11705	11715	11725	11735	11745	11755
GRMZM2G027021	AAGCAAAGTT	GAAAGTATGT	GTTCCCCCCT	CGTAGGCAGA	GGAGTTGTTT	TCCCAGCATG
	AAGCAAAGTT	GAAAGTATGT	GTTCCCCCCT	CGTAGGCAGA	GGAGTTGTTT	TCCCAGCATG
	.... ....	.... ....	.... ....	.... ....	.... ....	.... ....
	11765	11775	11785	11795	11805	11815
GRMZM2G027021	CCTTTTTGGG	TATCTACTGC	ACTTATTTAT	TTGGATTGGA	ATGAAGGGCC	TCTGTGGTCC
	CCTTTTTGGG	TATCTACTGC	ACTTATTTAT	TTGGATTGGA	ATGAAGGGCC	TCTGTGGTCC
	.... ....	.... ....	.... ....	.... ....	.... ....	.... ....
	11825	11835	11845	11855	11865	11875
GRMZM2G027021	TGATCTAAGA	ATTTTAGGAG	CTGGTCATAC	CTAGCTCCAG	AAATTATTGG	AGCCAGAGCT
	TGATCTAAGA	ACTTATGGAG	CTGGTCATAC	CTAGCTCCAG	AAATTATTGG	AGCCAGAGCT
	.... ....	.... ....	.... ....	.... ....	.... ....	.... ....
	11885	11895	11905	11915	11925	11935
GRMZM2G027021	GTAGGCATAT	ACGAGTACAT	GTTATGCCTA	TGGTGCCT	GGGCCTGGC	CAGGACTCCT
	GTAGGCATAT	ACAAGTACAT	GTTATGCCTA	TGGTGCCTA	GTCAGGGGC	CTGGCCATGA
	.... ....	.... ....	.... ....	.... ....	.... ....	.... ....
	11945	11955	11965	11975	11985	11995
GRMZM2G027021	TAGTTTTAGT	TAAATAGATA	GGATTAGAT~	~~~~AAGGTT	GTTAGGAGAT	AGAGTTGTGG
	CTCCTTAGTT	TTAGTTAAAT	AAATAGGATT	AGATAAGGTT	GTTAGGAGAT	AAAGTTGTGG
	.... ....	.... ....	.... ....	.... ....	.... ....	.... ....
	12005	12015	12025	12035	12045	12055
GRMZM2G027021	GATTTGTTAG	GGGCTGGCTC	TATGTAAAGA	GAGGCACCAC	AGTTAGTTGA	GGCAACAATG
	GATTTGTTAG	GGGCTGGCTC	TATGTAAAGA	GAGGCACCAC	AGTTAGTTGA	GGCAACAATG
	.... ....	.... ....	.... ....	.... ....	.... ....	.... ....
	12065	12075	12085	12095	12105	12115
GRMZM2G027021	AAGAACAGCC	AGTCCAATTC	CCTCAAATAC	TTAGTAGTCT	AATCTCCCTC	AAAAACCAAC
	AAGAACAGCC	AGTCCAATTC	CCTCAAATAC	TTAGTAGTCT	AATCTCCCTC	AAAAACCAAC



	.... ....	.... ....	.... ....	.... ....	.... ....	.... ....
	12125	12135	12145	12155	12165	12175
GRMZM2G027021	TTGCCAGC	TATCTCTTG	GCAATGTTAA	CCCTAATGAT	CTAAGGATCA	TAAACACAGA
	TTGCCAGC	TATCTCTTG	GCAATGTTAA	CCCTAATGAT	CTAAGGATCA	TAAACACAGA
	.... ....	.... ....	.... ....	.... ....	.... ....	.... ....
	12185	12195	12205	12215	12225	12235
GRMZM2G027021	GGGTATTAG	CTGAGGTATT	TCCTTATTTT	GGATCAATGA	CGGATGTCAT	ACTCGGTGCT
	GGGTATTAG	CTGAGGTATT	TCCTTATTTT	GGATCAATCA	CGGATGTCAT	ACTCGGTGCT
	.... ....	.... ....	.... ....	.... ....	.... ....	.... ....
	12245	12255	12265	12275	12285	12295
GRMZM2G027021	GAAAGCTCCT	ACACGATGTG	GGGTATGGGG	AATGGAATTT	CTAGTTAGAG	CTGCAGAAGG
	GAAAGCTCCT	ACACGATGTG	GGGTATGGGG	AATGGAATTT	CTAGTTAGAG	CTGCAGAAGG
	.... ....	.... ....	.... ....	.... ....	.... ....	.... ....
	12305	12315	12325	12335	12345	12355
GRMZM2G027021	GATTGTTGGG	GCGAAGGCGA	AGACGCTACC	CTTCGCTCCA	AGCCTTCGTC	AACCTCGTCG
	GA~~~~~	~~~~~	~~~~~	~~~~~	~~~~~	~~~~~
	.... ....	.... ....	.... ....	.... ....	.... ....	.... ....
	Gene Deletion					
	.... ....	.... ....	.... ....	.... ....	.... ....	.... ....
	12785	12795	12805	12815	12825	12835
GRMZM2G027021	AGGGATTAAA	CACAGATGTT	TAAAGCACCT	ATTTTATCCT	ACTAGTGAAA	AAAATCTGCA
	~~~~~TAAA	CACAGATGTT	TAAAGCACCT	ATTTTATCCT	ACTAGTGAAA	AAA~TCTGCA
	.... ....	.... ....	.... ....	.... ....	.... ....	.... ....
	12845	12855	12865	12875	12885	12895
GRMZM2G027021	TAGACTCGTT	GACTCATTGT	GGTGTGAGA	CCTCCACTG	CCACTAGCTT	CTTTAATTCT
	TAGACTCGAT	GACTCATTGT	GGTGTGAGA	CCTCCACTG	CCACTAGCTT	CTTTAATTCT
	.... ....	.... ....	.... ....	.... ....	.... ....	.... ....
	12905	12915	12925	12935	12945	12955
GRMZM2G027021	TGGTGGTGCC	ATGCAGCCAG	ATCTTTGCTC	AAAATGGAAG	AAAA~TGATT	TAATTTCTTA
	TGGTGGTGCC	ATGCAGCCAG	ATCTTTGCTC	AAAATGGAAG	AAAAATGATT	TAATTTCTTA
	.... ....	.... ....	.... ....	.... ....	.... ....	.... ....
	12965	12975	12985	12995	13005	13015
GRMZM2G027021	GTAATCCTAT	TFACTTAGGA	GCTTTGGAAG	TATAGGAATG	TCATTATTTT	TCAAGGTGTT
	GTAATCCTAG	TGATTTAGGA	GCTTTGGAAG	TATAGGAATG	TCATTGTTTT	TCAAGGTGTT
	.... ....	.... ....	.... ....	.... ....	.... ....	.... ....
	13025	13035	13045	13055	13065	13075
GRMZM2G027021	AGGCTAGATG	TCCAAAGTGT	TGTGT~~GCA	GTGGTTACTG	AAGGGCAGAT	GTGCTGCCTG
	AGGCTAGATG	TCCAAAGTGT	TGTGTCTGCA	GTGGTTACTG	AAGGGCAGAT	GTGGTGCTG
	.... ....	.... ....	.... ....	.... ....	.... ....	.... ....
	13085	13095	13105	13115	13125	13135
GRMZM2G027021	GCGTAGGGCT	TTGGCCCTCT	AGGACCTGGC	CCTTAAGGCT	GAACCACTTA	GG~~~~~
	GCGTAGGGCT	TTGGCCCTCT	AGGACCCC~	~TAAAGGCT	GAACCACTTA	GGCCTTGTC
	.... ....	.... ....	.... ....	.... ....	.... ....	.... ....
	13145	13155	13165	13175	13185	13195
GRMZM2G027021	~~~~~	~~~~~	~~~~~	~~~~~	~~~~~	~~~~~
	GGTTAATCCC	GTTACCTATG	AATTGGACGG	AATTGAAAAA	AAT'TATGAAG	AAATTTGACT
	.... ....	.... ....	.... ....	.... ....	.... ....	.... ....
	13205	13215	13225	13235	13245	13255
GRMZM2G027021	~~~~~	~~~~~	~~~~~	~~~~~	~~~~~	~~~~~
	TACTTGAGAT	TTAAACCCAC	ACAATCCTAA	TCAATCTACA	TGGATTGAGA	GCTAACCGAA
	.... ....	.... ....	.... ....	.... ....	.... ....	.... ....
	13265	13275	13285	13295	13305	13315
GRMZM2G027021	~~~~~	~GTCGAAAC	GGGGCCAATA	GTTTTTAAAT	GTGGGTTGTA	TTCCACCCTC
	CAAGCMCTTA	AGGTCGAAAC	GGGGCCAATA	GTTTTTAAAC	GTGGGTTGTA	TTTCACCCTC

	.... ....	.... ....	.... ....	.... ....	.... ....	.... ....
	13325	13335	13345	13355	13365	13375
GRMZM2G027021	TCCCCTGGAG	GTGGCTAATC	CATCGGGGGA	TTCTTTTTTC	TTTCTTAATG	AAATGAAGCT
	TCCCCTGGAG	GTGGCTAATC	CATCGGGGGA	TTCTTTTTTC	TTTCTTAATG	AAACGAAGCT
	.... ....	.... ....	.... ....	.... ....	.... ....	.... ....
	13385	13395	13405	13415	13425	13435
GRMZM2G027021	CTCCTGTGTG	GTTTCGAGAAA	AAAAATCTGC	ATATGAGCTG	GAGTTTTGCC	AAAGATGATG
	CTCCTGTGTG	GTTTCGAGAAA	AAAAATCTGC	ATATGAGCTG	GAGTTTTGCC	AAAGATGATG
	.... ....	.... ....	.... ....	.... ....	.... ....	.... ....
	13445	13455	13465	13475	13485	13495
GRMZM2G027021	TAAATCATGC	ATATTTGTCT	TCTACAGGAC	TCGATGGTTC	CTATAGAAGC	TTTTGTCCCA
	TAAATCATGC	ATATGTGTCT	TCTACAGGAC	TCGATGGTTC	CTATAGAAGC	TTTTGTCCCA
	.... ....	.... ....	.... ....	.... ....	.... ....	.... ....
	13505	13515	13525	13535	13545	13555
GRMZM2G027021	TATGACAAAG	GAGATCTCCT	GAATGACATA	CATAAGGTTG	GAATGGTTGA	AAAAATGGTG
	TATGACAAAG	GAGATCTCCT	GAATGACATA	CATAAGGTTG	GAATGGTTGA	AAAAATGGTG
	.... ....	.... ....	.... ....	.... ....	.... ....	.... ....
	13565	13575	13585	13595	13605	13615
GRMZM2G027021	AGTGTCTAT	TTGATTTAAG	ATGCAGTTTC	TTTGGCAATG	GTGTTTTTGA	GCTTCTGGTT
	AGTGTCTAT	TTGATTTAAG	ATGCAGTTTC	TTTGGCAATG	GTGTTTTTGA	GCTTCTGGTT
	.... ....	.... ....	.... ....	.... ....	.... ....	.... ....
	13625	13635	13645	13655	13665	13675
GRMZM2G027021	CATGTTGTCA	AGTTTCTGCT	TTTGTAAATT	TGTTCTGGAT	GAAATACACG	AGTTAATTCA
	CATGTTGTCA	AGTTTCTGCG	TTTGTAAATT	TGTTCTGGAT	GGAATACATG	AGTTAATTCA
	.... ....	.... ....	.... ....	.... ....	.... ....	.... ....
	13685	13695	13705	13715	13725	13735
GRMZM2G027021	TTCAACTACC	CCCAAATAGA	CAACTTAGGC	CTTATTTAAA	TGCACTAGAG	CTAATAATTA
	TTCAACTACC	TCCAAAGAGA	CAACTTAGGC	CTTATTTAAA	TGCACTAGAG	CTAATAATTA
	.... ....	.... ....	.... ....	.... ....	.... ....	.... ....
	13745	13755	13765	13775	13785	13795
GRMZM2G027021	GCTGGCTGTT	GCCCAACTAA	TAGCTGATT	GGTAAAAATA	GCTAATAGTT	GAACTATTAA
	GCTGGTTGTT	GCCTAACTAA	TAGCTGATT	GCTAGAAATA	GCTAATAGCT	GAACTATTAG
	.... ....	.... ....	.... ....	.... ....	.... ....	.... ....
	13805	13815	13825	13835	13845	13855
GRMZM2G027021	TTGGGCTGTT	TGGATGTTTG	CAGCTAATTT	TAGCAACTAA	CTATTATCTC	CTGTGCATTC
	TTGGGCTGTT	TGGATGTTTA	CAGCTAATTT	TAGCAACTAA	TTATTATCTC	TAGTGCATTC
	.... ....	.... ....	.... ....	.... ....	.... ....	.... ....
	13865	13875	13885	13895	13905	13915
GRMZM2G027021	AAACAGGCC	TTAGTCATGG	AAGCATGTGC	ATGGGTTACT	TGTTAAAATT	TTCTTTCTGA
	AAACATGGCC	TTAGTCATGG	AAGCATGTGC	ATGGGTTAAT	TGTTAAAATT	TTCTTTCTGA
	.... ....	.... ....	.... ....	.... ....	.... ....	.... ....
	13925	13935	13945	13955	13965	13975
GRMZM2G027021	ATAATCACAC	ATTTTTGCTT	ATTGCAAATC	TGCAAACCTA	GATAATATCT	AGACATTCCC
	ATAATCACAC	ATTTTTGCTT	ATTGCAAATC	TGCAAACCTA	GATAATATCT	AGACATTCCC
	.... ....	.... ....	.... ....	.... ....	.... ....	.... ....
	13985	13995	14005	14015	14025	14035
GRMZM2G027021	AAGTACACGA	TATATTGATT	TCTTGAGAAG	CTTTCACCTA	ACAGAAAATT	TGCTTTGCAT
	AAGTACACGA	TATATTGATT	TCTTGAGAAG	CTTTCACCTA	ACAGAAAATT	TGCTTTGCAT
	.... ....	.... ....	.... ....	.... ....	.... ....	.... ....
	14045	14055	14065	14075	14085	14095
GRMZM2G027021	TATTGTTTGG	ATTTAATGAT	AACTCCCCC	TCTTGCGATA	TTCACCTGCAG	GAGTACAAGG
	TATTGTTTGG	ATTTAATGAT	AACTCCCCC	TCTTGCGATA	TTCACCTGCAG	GAGTACAAGG
	.... ....	.... ....	.... ....	.... ....	.... ....	.... ....
	14105	14115	14125	14135	14145	14155
GRMZM2G027021	AAAGTGGGAC	ATTTGTAAAA	GCTCATGTGC	CTCTACCTCT	GGCAAGGCTT	CTCACACCTC
	AAAGTGGGAC	ATTTGTAAAA	GCTCATGTGC	CTCTACCTCT	GGCAAGGCTT	CTGACACCTC

	.... ....	.... ....	.... ....	.... ....	.... ....	.... ....
	14165	14175	14185	14195	14205	14215
GRMZM2G027021	TACGGCAGCA	GGTGGCAGCC	ACTGTGTGAT	GTGCATGTCC	CCGATCCCTT	GATGCCATTG
	TACGGCAGCA	GGTGGCAGCC	ACTGTGTGAT	GTGCATGTCC	CCGATCCCTT	GATGCCATTG
	.... ....	.... ....	.... ....	.... ....	.... ....	.... ....
	14225	14235	14245	14255	14265	14275
GRMZM2G027021	GCACTCACAA	AATTACCACA	TCTTGTAGAT	TCACAAAAGG	AATAGCTTTG	CTGTAGAAAA
	GCACTCACAA	AATTACCACA	TCTTGTAGAT	TCACAAAAGG	AATAGCTTTG	CTGTAGAAAA
	.... ....	.... ....	.... ....	.... ....	.... ....	.... ....
	14285	14295	14305	14315	14325	14335
GRMZM2G027021	CTTA~~~~~	GATTATCTTC	ATTGTGTTTC	TACGGTTCTA	CCAGAGTACC	GTATCAACAG
	CTTA <b>ATCATA</b>	GATTATCTTC	ATTCTGTTTC	TACGGTTCTA	CCAGAGTAGC	GTATCAACAG
	.... ....	.... ....	.... ....	.... ....	.... ....	.... ....
	14345	14355	14365	14375	14385	14395
GRMZM2G027021	GTGCACAGGA	CTAGATAGCT	GTATGTACGC	ACAACAGAAA	TGTAAATGTT	CTCAGCAGAA
	GTGCACAGGA	CTAGATAGCT	GTATGTACGC	ACAACAGAAA	TGTAAATGTT	CTCAGCAGAA
	.... ....	.... ....	.... ....	.... ....	.... ....	.... ....
	14405	14415	14425	14435	14445	14455
GRMZM2G027021	TTTAAG~CCC	CGTTTTGGTTT	GGG~TAG~TC	~~~ACTTTTA	GTCCTAAAA	ATATAAACAT
	TTTAAG <b>GTCC</b>	CGTTTTGGTTT	GGAG <b>TGACTA</b>	<b>GTT</b> ACTTTTA	GTCCTAAAG	<b>AGC</b> AAACAT
	.... ....	.... ....	.... ....	.... ....	.... ....	.... ....
	14465	14475	14485	14495	14505	14515
GRMZM2G027021	GGTGACTAAA	ATAGGGTAAC	TAAATTTAAG	TTCTTTAGTC	ATCGAGGAGT	GGACTAAAGT
	GGTGACTAAA	<b>G</b> TAGGG <b>TGAC</b>	TAAATTTAAG	TTCTTTAG <b>CC</b>	ACCGAGGAG <b>A</b>	C~~~TAAAGT
	.... ....	.... ....	.... ....	.... ....	.... ....	.... ....
	14525	14535	14545	14555	14565	14575
GRMZM2G027021	AGGATTTTTA	CCTCATTTGC	TCTTTTCTTT	TTTTTTATTG	CAGCAGTCAT	CCACTAATTA
	AGGATTTTTA	CCTCATTTGC	CTTCTCTTTC	TT~~~~AGTG	CAGCAGTCAT	CTACTAATTA
	.... ....	.... ....	.... ....	.... ....	.... ....	.... ....
	14585	14595	14605	14615	14625	14635
GRMZM2G027021	ATAGGAGTAA	TATAGTCATT	ATTTCGATCA	ATTAATGCCT	TTTAGTCAGG	TTTAGTCACT
	AT <b>TGGGGTAA</b>	TACAGTCATT	ATT <b>CGCACCA</b>	ATTAATGCCT	TTTAGT <b>TAGG</b>	TTTAGTCACT
	.... ....	.... ....	.... ....	.... ....	.... ....	.... ....
	14645	14655	14665	14675	14685	14695
GRMZM2G027021	GGAACTAAAC	CAAACGAGGT	ACTTTAGTAA	CTAAACTTTA	GTCAGGTGAC	TAAAGAAACC
	GGAACTAAAC	~~~~~GGGGT	ACTTTAGT <b>GA</b>	CTAAAGTTTA	GTCAGGTGAC	TAAAGAAACC
	.... ....	.... ....	.... ....	.... ....	.... ....	.... ....
	14705	14715	14725	14735	14745	14755
GRMZM2G027021	AAACAGGAC~	~AACTCTCCT	TTTCCAGTT	TGAGAATCAT	TCTGACTACA	AGCATGGCC
	AAACAT <b>GAC</b>	<b>TA</b> ACTCT <b>CAT</b>	TTTCC <b>CGTG</b>	TGAGAATCAT	TCT <b>AT</b> CTACA	AGCAT <b>GT</b> CTC
	.... ....	.... ....	.... ....	.... ....	.... ....	.... ....
	14765	14775	14785	14795	14805	14815
GRMZM2G027021	<b>TGCCAACAG</b>	<b>GGGGACTTGA</b>	<b>GGGAGGGGT</b>	<b>GACAAGGGTT</b>	<b>TTTTTTGGGG</b>	<b>GGGGGGGGG</b>
	<b>GCTGTGCCAA</b>	<b>CTCAAA</b> TAGT	<b>GAACCCTCTG</b>	<b>GTCCAGATT</b>	<b>TGCAGATATA</b>	<b>AGAGCGTTT</b>
	.... ....	.... ....	.... ....	.... ....	.... ....	.... ....
	14825	14835	14845	14855	14865	14875
GRMZM2G027021	AGGAATGGGC	TTCCACC GC	CGGATCGCAA	TCAACGGCCC	AAAACCATTC	CTACGCCAGA
	GGATCTAGAT	GGCTAAATTT	TAGTCTTGTC	ACATCGAATT	AATGTTGAAT	ATTGACTGT
	.... ....	.... ....	.... ....	.... ....	.... ....	.... ....
	14885	14895	14905	14915	14925	14935
GRMZM2G027021	GCTCCCGACC	CCCGCACACA	CATCAAAAT	AAACTTTACT	GTTTATGGG	TGTTTACCTC
	TAGTTAAAAG	TATTAATAT	AATATAATTA	TAAAATAAAT	TACCTAAATA	AGGACTAAAC
	.... ....	.... ....	.... ....	.... ....	.... ....	.... ....
	14945	14955	14965	14975	14985	14995
GRMZM2G027021	CTAAAATTC	AAAACCCCC	CCATAGCAGC	GGACCCGCAA	AGAGAAAACA	AAGAAAAA
	AACAA <b>GATGA</b>	<b>ATTTGTTAAG</b>	<b>TCTA</b> ATTAGT	<b>TTATGATTTT</b>	<b>TTTTTCGAAA</b>	<b>ACGCAGGAG</b>

## GRMZM2G039971

```

      ....|....| ....|....| ....|....| ....|....| ....|....|
      1                                           60
GRMZM2G039971 CAACTCAAGT GTCCCTTCCA ATGGGTCTTT TT-CTGTGAG GTGCTTGAGA CTGTACCGGT
      CAACTCAAGT GTCCCTTCCA ATGGGTCTTT TTCTGTGAG GTGCTTGAGA CTGTACCGGT

      ....|....| ....|....| ....|....| ....|....| ....|....|
      61                                           120
GRMZM2G039971 GAAAAATAGT ATCTACATCA GCTTAATCGG GTTCTATATC GATTGTTTG TTCCACACTA
      GAAAAATAGT ATCTACATCA GCTTAATCGG GTTCTATATC GATTGTTTG TTCCACACTA

      ....|....| ....|....| ....|....| ....|....| ....|....|
      121                                           180
GRMZM2G039971 TATTTATCGG GTTCCATTGA CCAATCGTCG GATGAAAGCC TCAAGGCTCA TCCATAATCC
      TATTTATCGG GTTCCATTGA CCAATCGTCG GATGAAAGCC TCAAGGCTCA TCCATAATCC

      ....|....| ....|....| ....|....| ....|....| ....|....|
      181                                           240
GRMZM2G039971 TCCTCTATCT TAAAAACCAC CAGTACCGTA CAGAGGAAAA GAAGGCGAGA AATGAGAGGA
      TCCTCTATCT TAAAAACCAC CAGTACCGTA CAGAGGAAAA GAAGGCGAGA AATGAGAGGA

      ....|....| ....| ....| ....|.
      241                                           266
GRMZM2G039971 AATGGGGAAA AAAAGAAGAGA GAAAAT
      AATGGGGGAA AAAA-AAGAGA GAAAAT

```

## GRMZM2G039983

```

.....|.....| .....|.....| .....|.....| .....|.....| .....|.....|
      5          15          25          35          45          55
GRMZM2G039983 GC~~~~~GA ACGGACGAAC CCACACCATC ACCACCACCG GCCACCCTCT CCCTGCCTGT
GCACGAGCGA ACGGACGAAC CCACACCATC ACCACCACCG GCCACCCTCT CCCTGCCTGT

.....|.....| .....|.....| .....|.....| .....|.....| .....|.....|
      65          75          85          95          105         115
GRMZM2G039983 GCCCCCCCCG CTTGCGCTAC TCCTGCTCCT CCTCCTCCTC CGCC~~~~TCC CCCTCCCTCC
GCCCCCCCCG CTTGCGCTAC TCCTTCCCTT CCTCCTCCTC CGCCCCCCTCC ~~~~~~

.....|.....| .....|.....| .....|.....| .....|.....| .....|.....|
     125         135         145         155         165         175
GRMZM2G039983 TACAAATAGC CACCACCACC ACAGTGACGC AGCCGCCGCC GCAAACGTCG CCCCCGACCG
TACAAATAGC CACCACCACC ACAGCGACGC CGCCGCCGCC GCAAACGTCG CCCCCGACCG

.....|.....| .....|.....| .....|.....| .....|.....| .....|.....|
     185         195         205         215         225         235
GRMZM2G039983 AAGCCTAGCC ACCACCAGCA GCACCAGCAA CCTCGCGTAG CAGCGCTCGA CACCCTGGA
AAGCCTAGCC ACCACCAGCA GCACCAGCAA CCTCGCGTAG CAGCGCTCGA CACCCTGGA

.....|.....| .....|.....| .....|.....| .....|.....| .....|.....|
     245         255         265         275         285         295
GRMZM2G039983 CGCCCCGCGC CCGCGCGAAA GCA~~~~~ ~~~~~~ ~~~~~~ ~~~~~~
CGCCCCGCGC CCGCGCGAAA GCAAGTAATTCGC TTACTCTCCT TCGTCTCMC CGGCCGK

.....|.....| .....|.....| .....|.....| .....|.....| .....|.....|
      Gene Insertion

.....|.....| .....|.....| .....|.....| .....|.....| .....|.....|
     1925        1935        1945        1955        1965        1975
GRMZM2G039983 ~~~~~~ ~~~~~~ ~~~~~~ GGACCTTGAT TCTGTCTGTTG GCGATACCAT
AAAAAAGAAA TCGTTTTGGT GTTGACACA GGACCTTGAT TCTGTCTGTTG GCGATACCAT

.....|.....| .....|.....| .....|.....| .....|.....| .....|.....|
     1985        1995        2005        2015        2025        2035
GRMZM2G039983 GGATGTGTCC TACGAGAAGT GTGCTGATCC GTCGAACTCG GACCTGCCTA GCGCTGTTGT
GGATGTGTCC TACGAGAAGT GTGCTGATCC GTCGAACTCG GACCTGCCTA GCGCTGTTGT

.....|.....| .....|.....| .....|.....| .....|.....| .....|.....|
     2045        2055        2065        2075        2085        2095
GRMZM2G039983 TGATGCTGAG CGATACGACG ATGGCGGCTC CGAACACCTG GGATCTGCTG TAGTAGAGGG
TGATGCTGAG CGATACGACG ATGGCGGCTC CGAACACCTG GGATCTGCTG TAGTAGAGGG

.....|.....| .....|.....| .....|.....| .....|.....| .....|.....|
     2105        2115        2125        2135        2145        2155
GRMZM2G039983 AGCTACTGGA AACGAAGGGA ATTCGGGGAC CGAAAGTTCC GAGCAGACTG GTGATG~~~~
AGCTACTGGA AACGAAGGGA ATTCGGGGAC CGAAAGTTCC GAGCAGACTG GTGATGGTAA

.....|.....| .....|.....| .....|.....| .....|.....| .....|.....|
     2165        2175        2185        2195        2205        2215
GRMZM2G039983 ~~~~~~ ~~~~~~ ~~~~~~ ~~~~~~ ~~~~~~ ~~~~~~
GTTTGATGCT TGKGCCAATT CCAGTGAAGC ATTTAGCTCT TGGATCTGGC CGTTTGCTMT

.....|.....| .....|.....| .....|.....| .....|.....| .....|.....|
     2225        2235        2245        2255        2265        2275
GRMZM2G039983 ~~~~~~ ~~~~~~ ~~~~~~ ~~~~~~ ~~~~~~ ~~~~~~
GTGTTTRCTG AGTTAGATGC GCAGGRCAAT GCGTGCTGAC MCTGGATCAT GGTGTAATT

.....|.....| .....|.....| .....|.....| .....|.....| .....|.....|
     2285        2295        2305        2315        2325        2335
GRMZM2G039983 ~~~~~~ ~AGCGCGCT GGAGGAGGTG AAGGCTCTCC TGTGTATGTC GAAAACAGCG
GTATGAATTC AGAGCGCGCT GGAGGAGGTG AAGGCTCTCC TGTGTATGTC GAAAACAGCG

.....|.....| .....|.....| .....|.....| .....|.....| .....|.....|
     2345        2355        2365        2375        2385        2395
GRMZM2G039983 CTGATAAACA AGAGAGCCAG GAGACGACGG TTCCGATGGA AGAAACAGAA ACGAGCGACG
CTGATAAACA AGAGAGCCAG GAGACGACGG TTCCGATGGA AGAAACAGAA ACGAGCGACG

```

GRMZM2G039983      . . . . | . . . . | . . . . | . . . . | . . . . | . . . . | . . . . | . . . . |  
                          2405            2415            2425            2435            2445            2455  
 GCACCTCGAT CACGTCGATG GAGGATGCCC TGGAACCGAA CCGTCATCAC GATCTCCCGT  
 GCACCTCGAT CACGTCGATG GAGGATGCCC TGGAACCGAA CCGTCATCAC GATCTCCCGT

GRMZM2G039983      . . . . | . . . . | . . . . | . . . . | . . . . | . . . . | . . . . | . . . . |  
                          2465            2475            2485            2495            2505            2515  
 CGGAGCCTGA GGATGTGGGC AACCCACTC CTGATCCTGA TCAGTCCAGC GGCAAGAAGT  
 CGGAGCCTGA GGATGTGGGC AACCCACTC CTGATCCTGA TCAGTCCAGC GGCAAGAAGT

GRMZM2G039983      . . . . | . . . . | . . . . | . . . . | . . . . | . . . . | . . . . | . . . . |  
                          2525            2535            2545            2555            2565            2575  
 CCAAAGGAAA CAGTAGCGTG TTCCAGAGCG CAAGGAGGGT GCTGGCTTCA ACCAATAAG~  
 CCAAAGGAAA CAGTAGCGTG TTCCAGAGCG CAAGGAGGGT GCTGGCTTCA ACCAATAAG**G**

GRMZM2G039983      . . . . | . . . . | . . . . | . . . . | . . . . | . . . . | . . . . | . . . . |  
                          2585            2595            2605            2615            2625            2635  
**TGGGTATATC TCCATTTCTC TGAAACCCCC TTTTTTTCCC TTCATGTATG WTCCCATCAA**

GRMZM2G039983      . . . . | . . . . | . . . . | . . . . | . . . . | . . . . | . . . . | . . . . |  
                          2645            2655            2665            2675            2685            2695  
**CATTTTTTCT ATCAKAGTCA CACGGAAATA ATGCTCAACA TTTTTTTTTT TGCGAGAAAA**

GRMZM2G039983      . . . . | . . . . | . . . . | . . . . | . . . . | . . . . | . . . . | . . . . |  
                          2705            2715            2725            2735            2745            2755  
 CTCCATCTGC AACTGCACGG AAGCCACTGC AGTTGACTAA CAGAGGTAAC CAGGATGACG  
 CTCCATCTGC AACTGCACGG AAGCCACTGC AGTTGACTAA CAGAGGTAAC CAGGATGACG

GRMZM2G039983      . . . . | . . . . | . . . . | . . . . | . . . . | . . . . | . . . . | . . . . |  
                          2765            2775            2785            2795            2805            2815  
 CGAAATCGTC GGCTGGAAAG GCCGCCACGG TTCCATCAGG CCCGGTTTTT CGCTGTACTG  
 CGAAATCGTC GGCTGGAAAG GCCGCCACGG TTCCATCAGG CCCGGTTTTT CGCTGTACTG

GRMZM2G039983      . . . . | . . . . | . . . . | . . . . | . . . . | . . . . | . . . . | . . . . |  
                          2825            2835            2845            2855            2865            2875  
 AACGGGCCGA GAAGCGCAGA GAA~~~~~~ ~~~~~~ ~~~~~~ ~~~~~~ ~~~~~~  
 AACGGGCCGA GAAGCGCAGA GAA**GTATGTG ACATAACTTT CTCTCTCTTT TTTTTTTAGA**

GRMZM2G039983      . . . . | . . . . | . . . . | . . . . | . . . . | . . . . | . . . . | . . . . |  
                          2885            2895            2905            2915            2925            2935  
**AACTATGAAT CAGAACTTG GTAAAGGGGG GAATAATGTG GTTATGATTG TTGTTTTTCAT**

GRMZM2G039983      . . . . | . . . . | . . . . | . . . . | . . . . | . . . . | . . . . | . . . . |  
                          2945            2955            2965            2975            2985            2995  
 ~~~~~~AAA ~~~~~TTTTAT ATGAAGCTGG AGGAGAAGCA TCAAGCTATG GAGGAAGAGA  
**GCTTTGCTTC GCAGTTTTAT ATGAAGCTGG AGGAGAAGCA TCAAGCTATG GAGGAAGAGA**

GRMZM2G039983      . . . . | . . . . | . . . . | . . . . | . . . . | . . . . | . . . . | . . . . |  
                          3005            3015            3025            3035            3045            3055  
 AGATTCAGTT GGAGGCTAAG TTGAAG~~~~~ ~~~~~~ ~~~~~~ ~~~~~~ ~~~~~~  
 AGATTCAGTT GGAGGCTAAG TTGAAG**GTAA ATAAATTTAT CTATATGGCT GCCATTTGAC**

**Gene Insertion**

GRMZM2G039983      . . . . | . . . . | . . . . | . . . . | . . . . | . . . . | . . . . | . . . . |  
                          3185            3195            3205            3215            3225            3235  
 ~~~~~~AAA GAGCAGGAGG AGGCACTGAA GCAGCTGAGG AAGAGCCTGA CCTTCAAAGC  
**ATTTTCAGAAA GAGCAGGAGG AGGCACTGAA GCAGCTGAGG AAGAGCCTGA CCTTCAAAGC**

GRMZM2G039983      . . . . | . . . . | . . . . | . . . . | . . . . | . . . . | . . . . | . . . . |  
                          3245            3255            3265            3275            3285            3295  
 CAACCCCATG CCGAGCTTCT ACCACGAGGC GACGCCGTCC CCGAAGGCCG AGTTCAGGAA  
 CAACCCCATG CCGAGCTTCT ACCACGAGGC GACGCCGTCC CCGAAGGCCG AGTTCAGGAA

|               |            |             |            |            |            |             |
|---------------|------------|-------------|------------|------------|------------|-------------|
|               | .... ....  | .... ....   | .... ....  | .... ....  | .... ....  | .... ....   |
|               | 3305       | 3315        | 3325       | 3335       | 3345       | 3355        |
| GRMZM2G039983 | GCTGCCACG  | ACCCGGCCA   | AGTCGCCAA  | GCTGGGCAGG | AGGAAGACGG | CCTCGACCTC  |
|               | GCTGCCACG  | ACCCGGCCA   | AGTCGCCAA  | GCTGGGCAGG | AGGAAGACGG | TCTCGACCTC  |
|               | .... ....  | .... ....   | .... ....  | .... ....  | .... ....  | .... ....   |
|               | 3365       | 3375        | 3385       | 3395       | 3405       | 3415        |
| GRMZM2G039983 | CATGGAGACG | TCCAACCTCGT | CGTCGGAGAG | CGAGGGCACG | AGGCCGTGCT | GCCGCGCCAG  |
|               | CATGGAGACG | TCCAACCTCGT | CGTCTGAGAG | CGAGGGCACG | AGGCCGTGCT | GCCGCGCCAG  |
|               | .... ....  | .... ....   | .... ....  | .... ....  | .... ....  | .... ....   |
|               | 3425       | 3435        | 3445       | 3455       | 3465       | 3475        |
| GRMZM2G039983 | CCGCGACGGC | CTCGACAGCA  | GCTGCAGATG | CGCGGCAGG  | AGCAGGCCGC | AGGCCCGGAA  |
|               | CCGCGACGGC | CTCGACAGCA  | GCTGCAGATG | CGCGGCAGG  | AGCAGGCCGC | AGGCCCGGAA  |
|               | .... ....  | .... ....   | .... ....  | .... ....  | .... ....  | .... ....   |
|               | 3485       | 3495        | 3505       | 3515       | 3525       | 3535        |
| GRMZM2G039983 | CGCCAAGCCG | GCCGCCGGGC  | CCAAGAAGCC | GCCGCCGCG  | CAGCAGCAGC | CGAAACACCG  |
|               | CGCCAAGCCG | GCCGCCGGGC  | CCAAGAAGCC | GCCGCCGCG  | CAGCAGCAGC | CGAAACACCG  |
|               | .... ....  | .... ....   | .... ....  | .... ....  | .... ....  | .... ....   |
|               | 3545       | 3555        | 3565       | 3575       | 3585       | 3595        |
| GRMZM2G039983 | CGCCCACAAG | ATCGCCGGCG  | AGGGCGCCAT | CAACATCGCC | GTGCACTAGC | CGCCGCCGCG  |
|               | CGCCCACAAG | ATCGCCGGCG  | AGGGCGCCAT | CAACATCGCC | GTGCACTAGC | CGCCGCCGCG~ |
|               | .... ....  | .... ....   | .... ....  | .... ....  | .... ....  | .... ....   |
|               | 3605       | 3615        | 3625       | 3635       | 3645       | 3655        |
| GRMZM2G039983 | GCTTCTTGAA | ACTTCTTTCC  | GGTCCGATGC | ATGCAGGACG | ATGGCGATGG | CGTGC GGATT |
|               | ~TCTTGAA   | ACTTCTTTCC  | GGTCCGATGC | ATGCAGGACG | ATGGCGATGG | CGTGC GGATT |
|               | .... ....  | .... ....   | .... ....  | .... ....  | .... ....  | .... ....   |
|               | 3665       | 3675        | 3685       | 3695       | 3705       | 3715        |
| GRMZM2G039983 | TTCCTTCTAA | GTTATGAGAG  | TGCTTTGTCG | GCTTGTGGAT | TTGGTGTAGA | TAATAATATA  |
|               | TTCCTTCTAA | GTTATGAGAG  | TGCTTTGTCG | GCTTGTGGAT | TTGGTGTAGA | TAATAATATA  |
|               | .... ....  | .... ....   | .... ....  | .... ....  | .... ....  | .... ....   |
|               | 3725       | 3735        | 3745       | 3755       | 3765       | 3775        |
| GRMZM2G039983 | AGTTATGGTG | ACGACGAACG  | AACAGGGGCT | GCTGCCACGA | GTGAGGCCGG | TCAGTCAGAC  |
|               | AGTTATGGTG | ACGACGAACG  | AACAGGGGCT | GCTGCCACGA | GTGAGGCCGG | TCAGTCAGAC  |
|               | .... ....  | .... ....   | .... ....  | .... ....  | .... ....  | .... ....   |
|               | 3785       | 3795        | 3805       | 3815       | 3825       | 3835        |
| GRMZM2G039983 | AGAGGTGGTG | GTGTTTATTG  | CTTGCTTGCT | TGTTTGTCTG | TTTGTTTGTT | TATTTATGCT  |
|               | AGAGGTGGTG | GTGTTTATTG  | CTTGCTTGCT | TGTTTGTCTG | TTTGTTTGTT | TATTTATGCT  |
|               | .... ....  | .... ....   | .... ....  | .... ....  | .... ....  | .... ....   |
|               | 3845       | 3855        | 3865       | 3875       | 3885       | 3895        |
| GRMZM2G039983 | AATCTTATTT | ATTTAATCTG  | CTGTGAGGGA | TGGCCTGCGC | ATTGCCACTG | TGCAGCGCTG  |
|               | AATCTTATTT | ATTTAATCTG  | CTGTGAGGGA | TGGCCTGCGC | ATTGCCACTG | TGCAGCGCTG  |
|               | .... ....  | .... ....   | .... ....  | .... ....  | .... ....  | .... ....   |
|               | 3905       | 3915        | 3925       | 3935       | 3945       | 3955        |
| GRMZM2G039983 | CTTGTTTTTT | ~CGTCTT     | CTTAATTTAT | GGGAGTGGT  | AAGAGAGACT | TGAGCGCTGG  |
|               | CTTGTTTTTT | TTTCTTCTT   | CTTAATTTAT | GGGAGTGGT  | AAGAGAGACT | TGAGTGTGG   |
|               | .... ....  | .... ....   | .... ....  | .... ....  | .... ....  | .... ....   |
|               | 3965       | 3975        | 3985       | 3995       | 4005       | 4015        |
| GRMZM2G039983 | ATGTAACGTG | TACAAACGAA  | AACGAAGGCT | TGCTGGTGGT | GGTGATGGAG | GATTTTATCT  |
|               | ATGTAACGTG | TACAAACGAA  | AACGAAGGCT | TGCTGGTGGT | GGTGATGGAG | GATTTTATCT  |
|               | .... ....  | .... ....   | .... ....  | .... ....  | .... ....  | ..          |
|               | 4025       | 4035        | 4045       | 4055       | 4065       |             |
| GRMZM2G039983 | GAACTATGCT | CACTCGCTGC  | ATTTCTATTG | AGTTCCTCAA | GAGCTTGCTA | AA          |
|               | GAACTATGCT | CATTCGCTGC  | ACTTCTATTG | AGTTCCTCAA | GAGCTTGCTA | AA          |